



# LA70001, 70001M

## Record/Playback Amplifiers for VHS Format VCRs

### Overview

The LA70001 and LA70001M ICs provide record and playback amplifiers for VHS format VCRs. A system with an adjustment-free Y/C record current can be achieved by combining the LA70001/M with an LA71000M or LA71500M video signal processing IC.

### Features

- Direct connection of the head to the playback amplifier input allows the number of external devices to be reduced.
- A fixed-current drive technique that is strongly resistant to load fluctuations is adopted in the record amplifier for stable recording characteristics. The record amplifier includes a built-in AGC circuit.
- These products have the same package dimensions as the LA70011 and LA70011M to allow a common PCB to be used. These products can also share the same PCB with the LA70020 by mounting the IC at the right end of the LA70020 socket.

### Specifications

#### Maximum Ratings at $T_a = 25^\circ\text{C}$

Parameter	Symbol	Conditions	Ratings	Unit
Maximum supply voltage	$V_{CC \text{ max}}$		7.0	V
Allowable power dissipation	$P_{d \text{ max}}$	$T_a \leq 65^\circ\text{C}$ [LA70001]	600	mW
		$T_a \leq 65^\circ\text{C}$ [LA70001M] (Using a $114.3 \times 76.1 \times 1.6$ mm glass epoxy PCB)	500	mW
Operating temperature	$T_{opr}$		-10 to +65	$^\circ\text{C}$
Storage temperature	$T_{stg}$		-40 to +150	$^\circ\text{C}$

#### Operating Conditions at $T_a = 25^\circ\text{C}$

Parameter	Symbol	Conditions	Ratings	Unit
Recommended supply voltage	$V_{CC}$		5.0	V
Operating supply voltage range	$V_{CC \text{ op}}$		4.8 to 5.5	V

### Package Dimensions

unit: mm

#### 3067-DIP24S

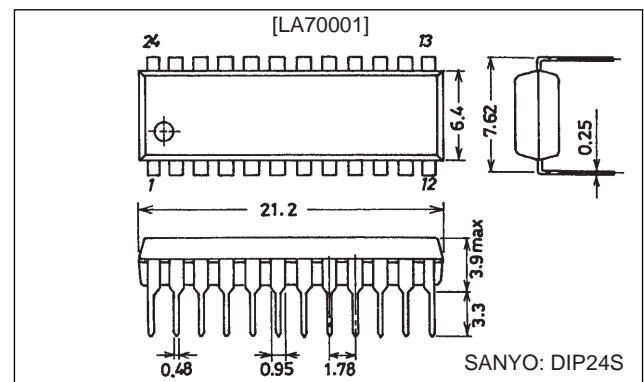

unit: mm

#### 3112-MFP24S

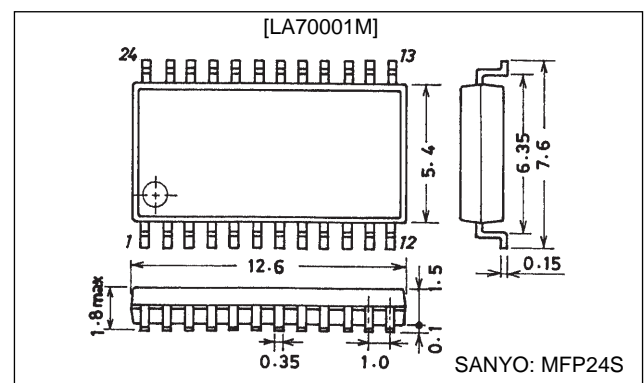

LA70001, 70001M

Electrical Characteristics at Ta = 25°C

Parameter	Symbol	Conditions	Ratings			Unit
			min	typ	max	
[Playback Mode]						
Current drain	$I_{CCP}$	The pin 13 inflow current.	23	29	35	mA
Voltage gain	CH1 $G_{VP1}$	$V_{IN} = 38 \text{ mVp-p}$ , $f = 1 \text{ MHz}$	56	59	62	dB
	CH2 $G_{VP2}$		56	59	62	
Voltage gain difference 1	$\Delta G_{VP1}$	$G_{VP1} - G_{VP2}$	-1	0	+1	dB
Equivalent input noise voltage	CH1 CH2 $V_{NIN1}$ $V_{NIN2}$	With the same conditions as for the voltage gain, the ratio of the output passed through a 1.1-MHz low-pass filter and the output with no input signal.		1.0	1.5	$\mu\text{Vrms}$
Frequency characteristics	CH1 CH2 $\Delta V_{fp1}$ $\Delta V_{fp2}$	The ratio of the output for $V_{IN} = 38 \text{ mVp-p}$ , $f = 7 \text{ MHz}$ and $G_{VP1}$ , 2, 3, and 4.	-2.5	0		dB
Second harmonic distortion	CH1 CH2 $V_{HDP1}$ $V_{HDP2}$	With $V_{IN} = 38 \text{ mVp-p}$ , $f = 4 \text{ MHz}$ , the ratio of the 8-MHz output component (second harmonic) and the 4-MHz component (the fundamental).		-40	-35	dB
Maximum output level	CH1 CH2 $V_{OMP1}$ $V_{OMP2}$	At $f = 1 \text{ MHz}$ , the output level when the ratio of the 3-MHz output (third harmonic) and the 1-MHz output (fundamental) is -30 dB.	1.0	1.2		Vp-p
Crosstalk SP	$V_{CR1}$	The ratio of the $V_{IN} = 38 \text{ mVp-p}$ , $f = 4 \text{ MHz}$ output and $G_{VP1}$ .		-40	-35	dB
Output DC offset	$\Delta V_{ODC1}$	CH1 - CH2	-100	0	+100	mV
Envelope detector output pin voltage	$V_{ENV}$	The T6 DC level when there is no input signal.	0	0.8	1.3	V
Envelope detector output pin voltage SP1	$V_{ENVSP1}$	With a $f = 4 \text{ MHz}$ input, the T6 DC level when the T7A output level becomes 175 mVp-p.	2.0	2.5	3.0	V
	$V_{ENVSP2}$	With a $f = 4 \text{ MHz}$ input, the T6 DC level when the T7A output level becomes 400 mVp-p.	3.5	4.0	4.5	V
Envelope detector output pin voltage EP	$V_{ENVEP1}$	With a $f = 4 \text{ MHz}$ input, the T6 DC level when the T7A output level becomes 125 mVp-p.	2.0	2.5	3.0	V
	$V_{ENVEP2}$	With a $f = 4 \text{ MHz}$ input, the T6 DC level when the T7A output level becomes 300 mVp-p.	4.0	4.5	5.0	V
Switch transistor on resistance in playback mode	$R_{PON18}$	Measure the difference in the DC levels with a 1-mA and a 2-mA inflow current.		4	6	$\Omega$
SW30 threshold level	SW30-1	Lch $\rightarrow$ Hch *1	1.2		5.0	V
	SW30-2	Hch $\rightarrow$ Lch	0.0		0.8	V
[Record Mode]						
Current drain	$I_{CCR}$	The pin 13 inflow current.	43	50	57	mA
Record AGC amplifier output level	$V_{RSP}$	The output level when $V_{IN} = 400 \text{ mVp-p}$ , $f = 4 \text{ MHz}$ .	105	112	119	mVp-p
Record AGC amplifier control characteristics	$\Delta V_{AGC1-SP}$	At $f = 4 \text{ MHz}$ , when $V_{IN} = 700 \text{ mVp-p}$ : the output level /VRSP, EP		0.5	1.0	dB
	$\Delta V_{AGC2-SP}$	At $f = 4 \text{ MHz}$ , when $V_{IN} = 100 \text{ mVp-p}$ : the output level /VRSP, EP	-1.0	-0.5		dB
Record AGC amplifier frequency characteristics	$\Delta V_{FRS}$	At $V_{IN} = 400 \text{ mVp-p}$ , the ratio of the outputs when $f$ is 1 MHz and 7 MHz, i.e. the ratio of the 7-MHz value to the 1-MHz value.*2.	-1	0	+1	dB
Record AGC amplifier second harmonic distortion	$\Delta V_{HDRS}$	With $V_{IN} = 400 \text{ mVp-p}$ , $f = 4 \text{ MHz}$ , the ratio of the 8-MHz output component (second harmonic) and the 4-MHz component (the fundamental).		-45	-40	dB
Record AGC amplifier maximum output level	$\Delta V_{MOSP}$	At $f = 4 \text{ MHz}$ , the output level at which the second harmonic goes to -35 dB. *3	20	22		mAp-p
Record AGC amplifier muting attenuation	$\Delta V_{MRS}$	When $V_{IN} = 400 \text{ mVp-p}$ and $f = 4 \text{ MHz}$ , the output level /VRSP, EP		-45	-40	dB
Record AGC amplifier cross modulation relative level	$\Delta V_{CYS}$	T9A: $V_{IN} = 400 \text{ mVp-p}$ , $f = 4 \text{ MHz}$ T10A: $V_{IN} = 2.4 \text{ Vp-p}$ , $f = 629 \text{ kHz}$ The ratio of the (4 MHz $\pm$ 629 kHz) and the 4-MHz outputs.		-45	-40	dB
Record muting threshold level	MUTE-1	MUTE OFF $\rightarrow$ MUTE ON *1	1.2		2.8	V
	MUTE-2	MUTE ON $\rightarrow$ MUTE OFF	3.2		5.0	V
Record mode to playback mode threshold level	PB-REC	PB $\rightarrow$ REC *1	1.2		5.0	V
	REC-PB	REC $\rightarrow$ PB	0.0		0.8	V

Notes: Use a resistor with an accuracy of 1.0% for the resistor between pins 13 and 14.

\*1. This is the voltage application point

\*2. Here, fix the AGC amplifier gain by applying a 1.8-V DC level to the AGC detector filter pin (pin 15).

\*3. Here, adjust the output level by applying a DC voltage to the REC-CUR-Adj pin (pin 12).

LA70001, 7001M

Pin Functions

Pin No.	Pin name	Standard DC voltage (V)		Equivalent circuit	Notes		
1	N.C						
2	N.C						
3	HA (EP/SP)				<table border="1"> <tr><td>EP</td></tr> <tr><td>SP</td></tr> </table> 1.5 V	EP	SP
EP							
SP							
4	SW30				<table border="1"> <tr><td>Hch</td></tr> <tr><td>Lch</td></tr> </table> 1.0 V	Hch	Lch
Hch							
Lch							
5	H-SYNC				<table border="1"> <tr><td>SYNC H</td></tr> <tr><td>L</td></tr> </table> 1.5 V	SYNC H	L
SYNC H							
L							
6	ENVDET-OUT	PB	Provided in a separate document.				
		REC	0				
7	PB-OUT	PB	1.7				
		REC	2.1				
8 20	GND						

Continued on next page.

## LA70001, 70001M

Continued from preceding page.

Pin No.	Pin name	Standard DC voltage (V)		Equivalent circuit	Notes						
9	REC-Y-IN	PB	4.0								
		REC	3.7								
10	REC-C-IN	PB	4.0								
		REC	3.7								
11	REC/MUTE/PB				<table border="1" style="margin-left: auto; margin-right: auto;"> <tr> <td>REC</td> <td>3.0 V</td> </tr> <tr> <td>REC MUTE</td> <td>1.0 V</td> </tr> <tr> <td>PB</td> <td></td> </tr> </table>	REC	3.0 V	REC MUTE	1.0 V	PB	
REC	3.0 V										
REC MUTE	1.0 V										
PB											
12	REC-CURRENT-ADJ2	PB	2.5 V								
		REC	2.5 V								
13	V <sub>CC</sub>										
14	REC-CURRENT-ADJ1	PB	5.0								
		REC	4.5								

Continued on next page.

LA70001, 70001M

Continued from preceding page.

Pin No.	Pin name	Standard DC voltage (V)		Equivalent circuit	Notes
15	REC-AGC-FILT	PB	0		
		REC	1.6		
16 19	L IN H IN	PB	2.1		
		REC	4.1		
17	REC_SP_OUT	PB	2.1 V		
		REC	4.1 V		
18	PB FILT	PB	0		
		REC	2.5		
21 22 23 24	N.C				

**Usage Notes**

Control Pin Logic

- HA-SW (EP/SP mode switching): pin 3

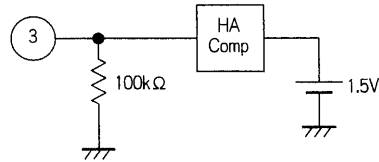

GND < the pin 3 DC level < 1.5 V: SP mode  
1.5 V < the pin 3 DC level < 5 V: EP mode

A09410

- H.SYNC input: pin 5

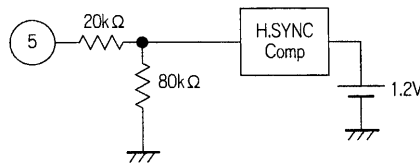

The pin 5 DC level > 1.5 V: The horizontal synchronization period

A09411

In record mode: Used as the REC-AGC-AMP synchronization block gate pulse.

- REC/REC-MUTE/PB switching: pin 11

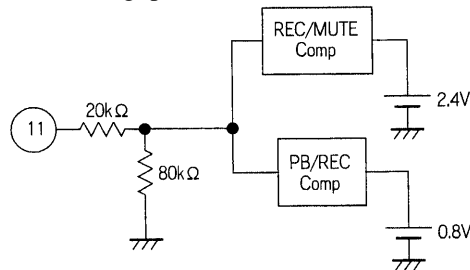

GND < the pin 11 DC level < 1.0 V: Playback mode  
1.0 V < the pin 11 DC level < 3.0 V: Record mode with recording muted.  
3.0 V < the pin 11 DC level < 5.0 V: Record mode

A09412

Envelope detection characteristics: pin 6

The LA70001 provides a built-in playback signal envelope detection circuit so that the tracking adjustment can be made automatic.

Envelope Detection Voltage Characteristics

The pin 6 detected DC level (V)

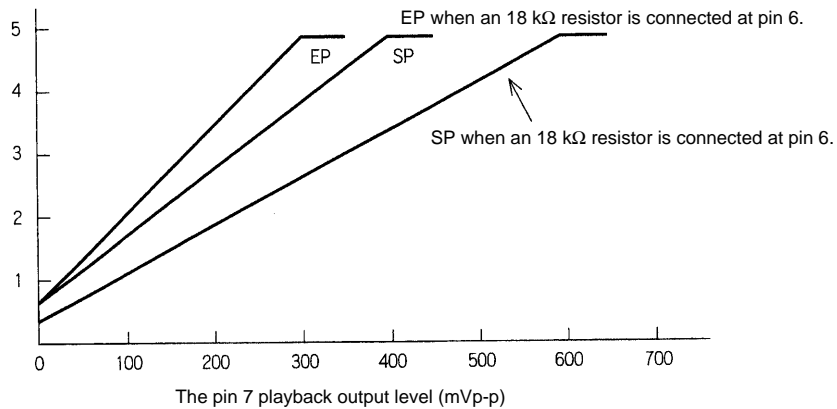

A09413

## LA70001, 7001M

### Record Amplifier Gain Control

The LA70001 achieves an adjustment-free record current by adding an AGC circuit in the record amplifier block. The record current can be modified using the following method.

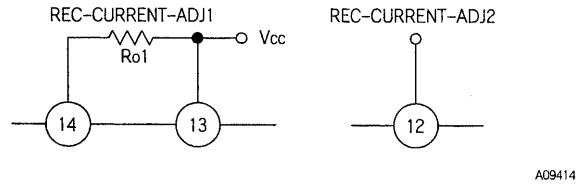

- Record current adjustment 2: When left open.  
Pin 12 DC level is set to  $1/2 V_{CC}$  (approximately 2.5 V) by an internal bias, and the record current is determined by  $R_{o1}$ .  
Design value: When  $R_{o1}$  is 1.5 k $\Omega$ , the record current will be 12.7 mA per channel.
- Record current adjustment 2: When used.  
The gain can be varied by -6.0 dB to +3.5 dB relative to the value set by  $R_{o1}$  by applying a control DC voltage of between 1 and 4 V to pin 12.

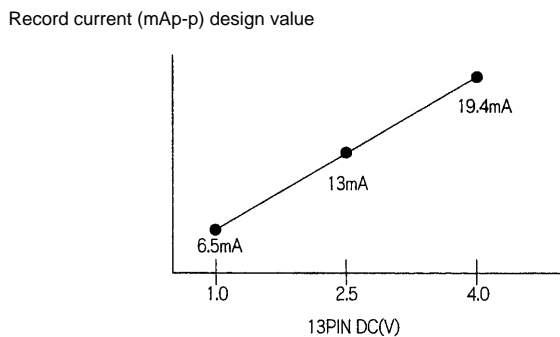

Note: The technique shown in the figure below can be used to apply a DC level to pin 12. This allows a control voltage of between 1 and 4 V to be applied.

