

OBSOLETE PRODUCT
 See HA-2520, HA-2522, HA-2525
 contact our Technical Support Center at
 1-888-INTERSIL or www.intersil.com/tsc

**20MHz, High Input Impedance,
 High Slew Rate Operational Amplifier**

The HA-2529 is a monolithic operational amplifier which typifies excellence of design. With a design based on years of experience coupled with the reliable dielectric isolation process, this amplifier provides an outstanding combination of DC and AC parameters at closed loop gains greater than 3.

The HA-2529 offers 150V/μs slew rate and fast settling time (200ns), while consuming a mere 6mA of quiescent current, making this amplifier ideal for video circuitry and data acquisition designs. With 20MHz gain bandwidth combined with 7.5kV/V open loop gain, the HA-2529 is an ideal component for demanding signal conditioning designs. This device provides ±30mA output current drive with an output voltage swing of ±10V making it suited for pulse amplifier and RF amplifier components.

The HA-2529 will upgrade output current, slew rate, offset voltage drift and offset current drift in systems presently using the HA-2520/22/25 or EHA-2520/22/25.

Pinout

MIL-STD-883 product and data sheets are available upon request.

Features

- High Slew Rate 150V/μs
- Fast Settling 200ns
- Full Power Bandwidth 2MHz
- Gain Bandwidth ($A_V \geq 3$) 20MHz
- High Input Impedance 130MΩ
- Low Offset Current 5nA
- High Output Current ±30mA

Applications

- Data Acquisition Systems
- RF Amplifiers
- Video Amplifiers
- Signal Generators
- Pulse Amplification

Part Number Information

PART NUMBER (BRAND)	TEMP. RANGE (°C)	PACKAGE	PKG. NO.
HA2-2529-2	-55 to 125	8 Pin Metal Can	T8.C
HA2-2529-5	0 to 75	8 Pin Metal Can	T8.C
HA3-2529-5	0 to 75	8 Ld PDIP	E8.3
HA7-2529-5	0 to 75	8 Ld CERDIP	F8.3A
HA9P2529-5 (H25295)	0 to 75	8 Ld SOIC	M8.15

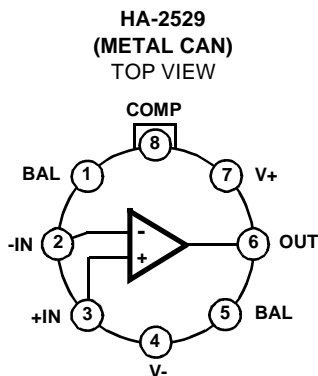
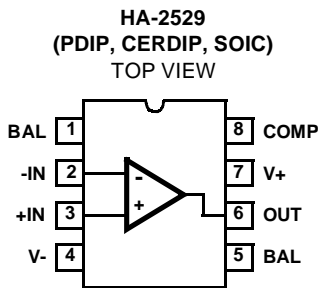

Absolute Maximum Ratings

Voltage Between V+ and V- Terminals	40V
Differential Input Voltage	15V
Peak Output Current	90mA

Operating Conditions

Temperature Range	
HA-2529-2	-55°C to 125°C
HA-2529-5	0°C to 75°C

Thermal Information

Thermal Resistance (Typical, Note 1)	θ_{JA} (°C/W)	θ_{JC} (°C/W)
Metal Can Package	165	80
PDIP Package	96	N/A
CERDIP Package	135	50
SOIC Package	157	N/A
Maximum Junction Temperature (Hermetic Package)	175°C	
Maximum Junction Temperature (Plastic Package)	150°C	
Maximum Storage Temperature Range	-65°C to 150°C	
Maximum Lead Temperature (Soldering 10s)	300°C (SOIC - Lead Tips Only)	

CAUTION: Stresses above those listed in "Absolute Maximum Ratings" may cause permanent damage to the device. This is a stress only rating and operation of the device at these or any other conditions above those indicated in the operational sections of this specification is not implied.

NOTE:

- θ_{JA} is measured with the component mounted on an evaluation PC board in free air.

Electrical Specifications $V_{SUPPLY} = \pm 15V$, $C_L = 50pF$, $R_L = 2k\Omega$, Unless Otherwise Specified

PARAMETER	TEST CONDITIONS	TEMP. (°C)	HA-2529-2 -55°C TO 125°C			HA-2529-5 0°C TO 75°C			UNITS
			MIN	TYP	MAX	MIN	TYP	MAX	
INPUT CHARACTERISTICS									
Offset Voltage (Note 2)		25	-	2	5	-	2	10	mV
		Full	-	-	8	-	-	14	mV
Average Offset Voltage Drift (Note 2)		Full	-	10	-	-	10	-	$\mu V/^\circ C$
Bias Current (Note 2)		25	-	50	200	-	50	250	nA
		Full	-	80	400	-	80	400	nA
Average Bias Current Drift (Note 2)		Full	-	0.2	-	-	0.2	-	$nA/^\circ C$
Offset Current (Note 2)		25	-	5	25	-	5	50	nA
		Full	-	10	50	-	10	100	nA
Average Offset Current Drift		Full	-	0.02	-	-	0.02	-	$nA/^\circ C$
Common Mode Range		Full	± 10	± 13	-	± 10	± 13	-	V
Differential Input Resistance (Note 3)		25	50	130	-	50	130	-	$M\Omega$
Differential Input Capacitance		25	-	3	-	-	3	-	pF
Input Noise Voltage	f = 1kHz	25	-	20	-	-	20	-	nV/\sqrt{Hz}
Input Noise Current	f = 1kHz	25	-	1.8	-	-	1.8	-	pA/\sqrt{Hz}
TRANSFER CHARACTERISTICS ($A_V \geq +3$)									
Large Signal Voltage Gain	$V_{OUT} = \pm 10V$	25	10	18	-	7.5	18	-	kV/V
		Full	7.5	15	-	5	15	-	kV/V
Common Mode Rejection Ratio	$\Delta V_{CM} = \pm 10V$	Full	80	100	-	74	100	-	dB
Gain Bandwidth Product (Note 3)	$V_{OUT} = \pm 200mV$	25	15	20	-	15	20	-	MHz
Minimum Stable Gain		25	3	-	-	3	-	-	V/V
OUTPUT CHARACTERISTICS									
Output Voltage Swing		Full	± 10	± 12	-	± 10	± 12	-	V
Full Power Bandwidth (Note 5)		25	2.1	2.6	-	2.1	2.6	-	MHz
Output Current (Note 2)		25	30	35	-	30	35	-	mA
		Full	25	30	-	25	30	-	mA
Output Resistance	Open Loop	25	-	30	-	-	30	-	Ω

Electrical Specifications $V_{SUPPLY} = \pm 15V$, $C_L = 50pF$, $R_L = 2k\Omega$, Unless Otherwise Specified (Continued)

PARAMETER	TEST CONDITIONS	TEMP. (°C)	HA-2529-2 -55°C TO 125°C			HA-2529-5 0°C TO 75°C			UNITS
			MIN	TYP	MAX	MIN	TYP	MAX	
TRANSIENT RESPONSE ($A_V = +3$)									
Rise Time (Note 6)	$V_{OUT} = \pm 200mV$	25	-	20	45	-	20	50	ns
Overshoot (Note 6)	$V_{OUT} = \pm 200mV$	25	-	10	30	-	10	30	%
Slew Rate (Note 6)	$V_{OUT} = \pm 10V$	25	135	150	-	135	150	-	V/ μs
Settling Time	Note 4	25	-	200	-	-	200	-	ns
POWER SUPPLY CHARACTERISTICS									
Supply Current		Full	-	4.5	6	-	4.5	6	mA
Power Supply Rejection Ratio	$\Delta V_S = \pm 10V$ to $\pm 20V$	Full	80	90	-	74	90	-	dB

NOTES:

- Refer to typical performance curve in data sheet.
- Parameter is guaranteed by design and characterization data.
- Settling Time is specified to 0.1% of final value for a 10V output step and $A_V = -3$. See Settling Time Test Circuit.
- Full Power Bandwidth is guaranteed by equation: $FPBW = \frac{\text{Slew Rate}}{2\pi V_{PEAK}}$, $V_{PEAK} = 10V$.
- See Transient Response Test Circuit (Figure 3).

Test Circuits and Waveforms

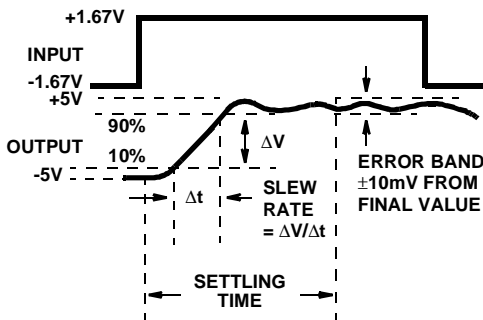
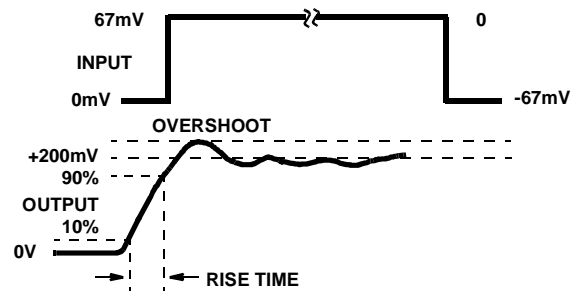

FIGURE 1. SLEW RATE AND SETTling TIME



NOTE: Measured on both positive and negative transitions from 0V to +200mV and 0V to -200mV at the output.

FIGURE 2. TRANSIENT RESPONSE

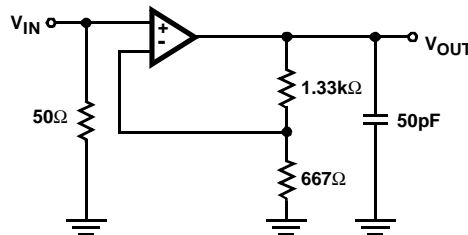
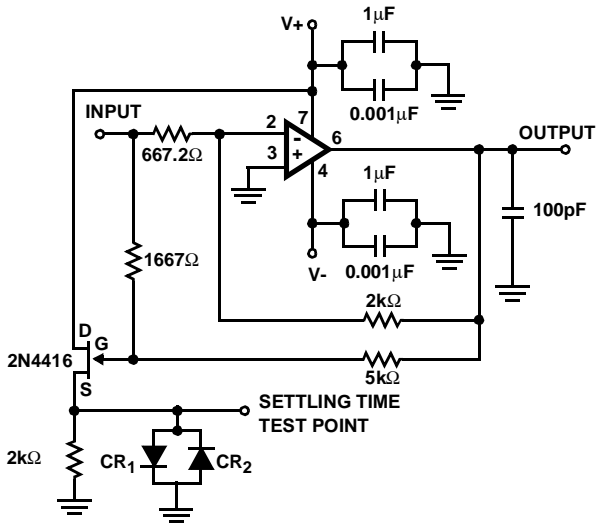

FIGURE 3. SLEW RATE AND TRANSIENT RESPONSE

Test Circuits and Waveforms (Continued)



NOTES:

- 7. $A_V = -3$.
- 8. Feedback and summing resistor ratios should be 0.1% matched.
- 9. Clipping diodes CR₁ and CR₂ are optional. HP5082-2810 recommended.

FIGURE 4. SETTLING TIME TEST CIRCUIT

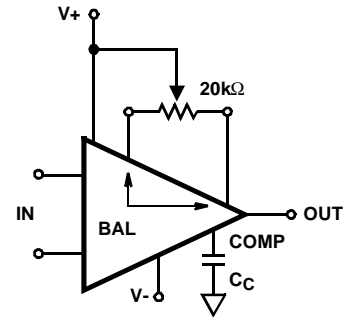

NOTE: Tested offset adjustment range is $|V_{OS} + 1mV|$ minimum referred to output. Typical ranges are +28mV to -18mV with $R_T = 20k\Omega$

FIGURE 5. SUGGESTED V_{OS} ADJUSTMENT AND COMPENSATION HOOK UP

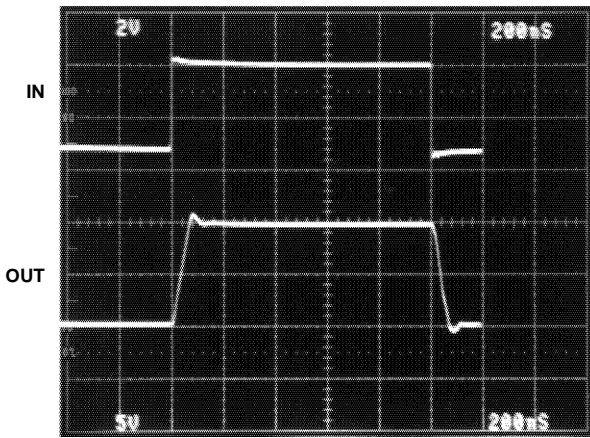

Horizontal Scale: 200ns/Div.
Vertical Scale: 2V/Div. Input, 5V/Div. Output

LARGE SIGNAL RESPONSE

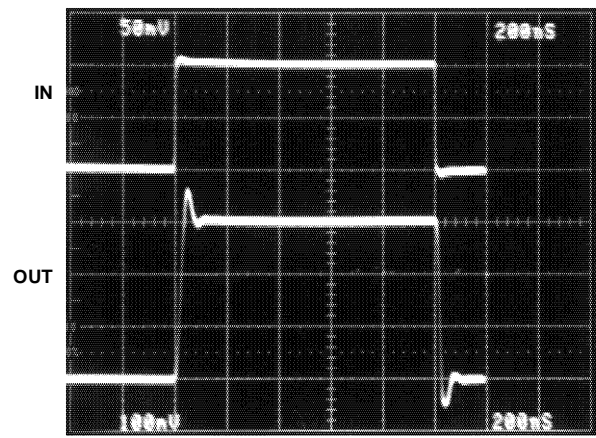

Horizontal Scale: 200ns/Div.
Vertical Scale: 50mV/Div. Input, 100mV/Div. Output

SMALL SIGNAL RESPONSE

Schematic Diagram

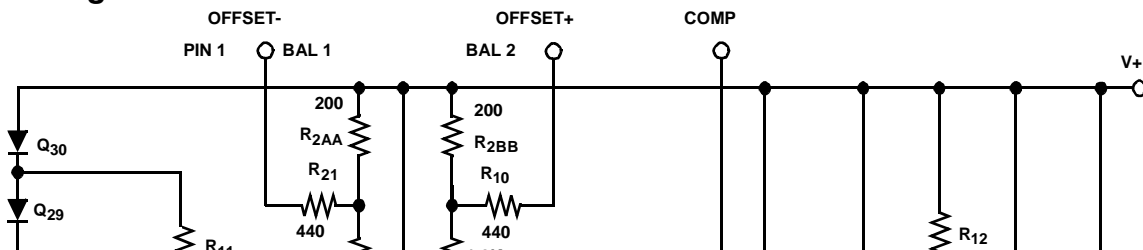

Typical Application

Inverting Unity Gain Circuit

Figure 6 shows a Compensation Circuit for an inverting unity gain amplifier. The circuit was tested for functionality with supply voltages from $\pm 4V$ to $\pm 15V$, and the performance as tested was: Slew Rate $\approx 120V/\mu s$; Bandwidth $\approx 10MHz$; and Settling Time (0.1%) $\approx 500ns$. Figure 7 illustrates the amplifier's frequency response, and it is important to note that capacitance at pin 8 must be minimized for maximum bandwidth.

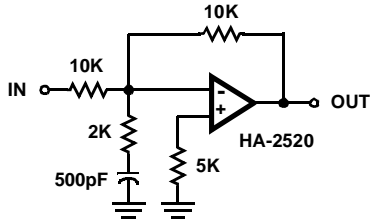

FIGURE 6. INVERTING UNITY GAIN CIRCUIT

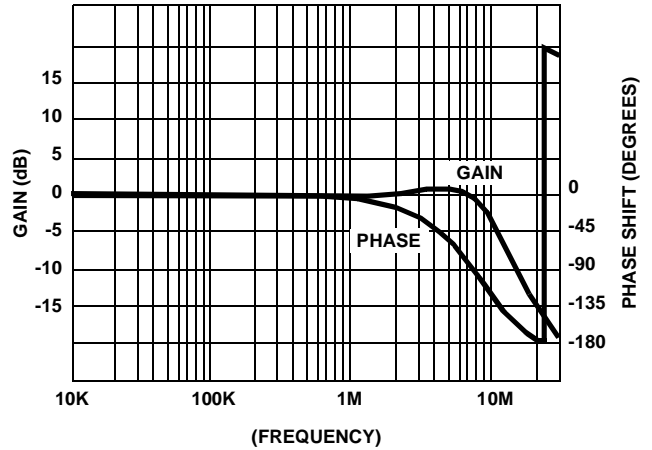

FIGURE 7. FREQUENCY RESPONSE FOR INVERTING UNITY GAIN CIRCUIT

Typical Performance Curves $V_{SUPPLY} = \pm 15V$

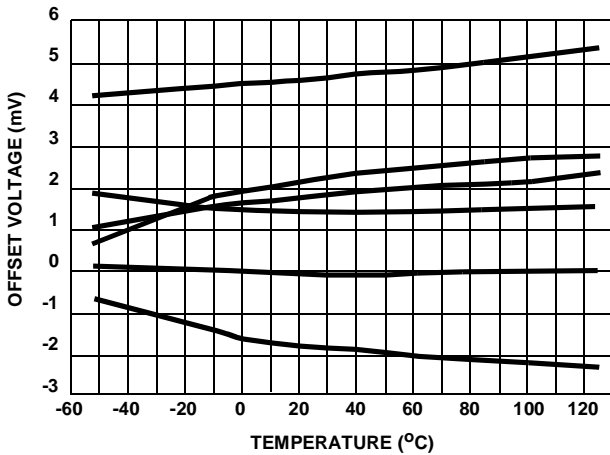

FIGURE 8. OFFSET VOLTAGE vs TEMPERATURE (6 TYPICAL UNITS FROM 3 LOTS)

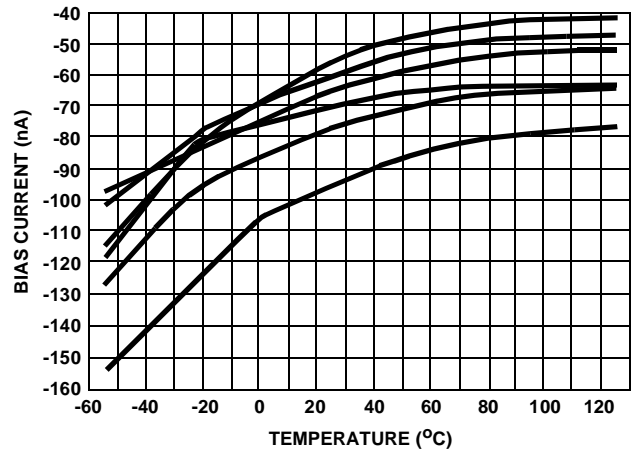

FIGURE 9. BIAS CURRENT vs TEMPERATURE (6 TYPICAL UNITS FROM 3 LOTS)

Typical Performance Curves $V_{SUPPLY} = \pm 15V$ (Continued)

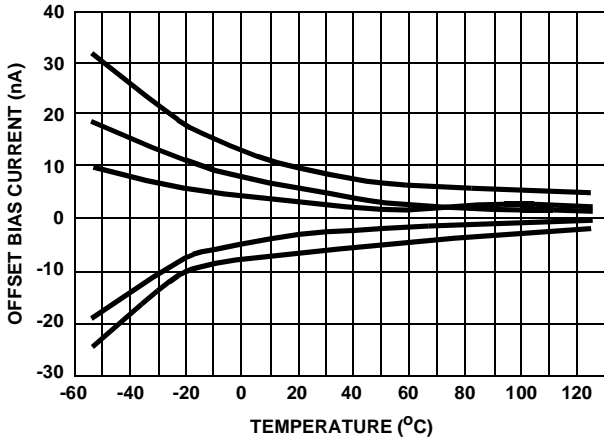

FIGURE 10. OFFSET CURRENT vs TEMPERATURE (5 TYPICAL UNITS FROM 3 LOTS)

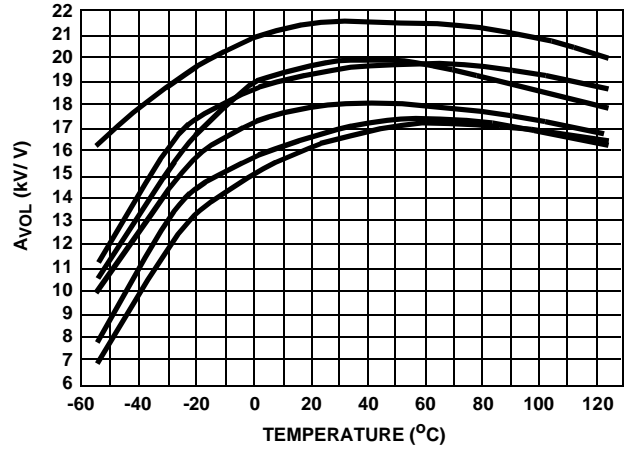

FIGURE 11. OPEN LOOP GAIN vs TEMPERATURE (6 TYPICAL UNITS FROM 3 LOTS)

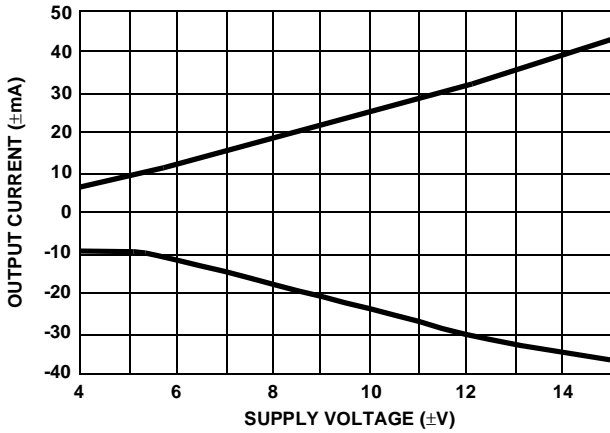

FIGURE 12. OUTPUT CURRENT vs SUPPLY VOLTAGE

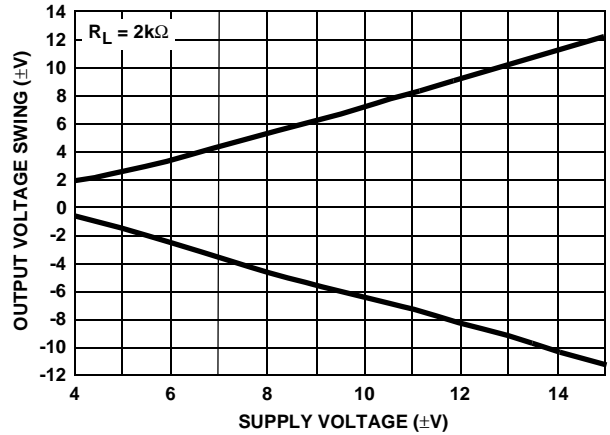

FIGURE 13. OUTPUT VOLTAGE SWING vs SUPPLY VOLTAGE

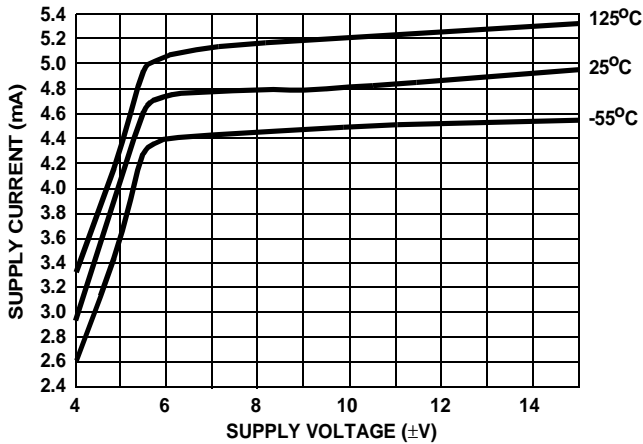

FIGURE 14. SUPPLY CURRENT vs SUPPLY VOLTAGE

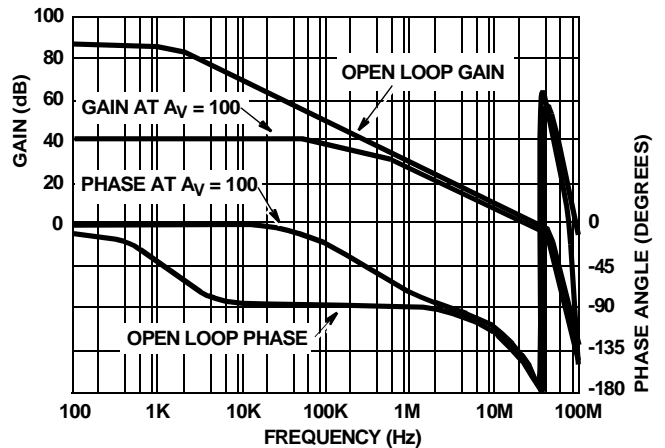

FIGURE 15. FREQUENCY RESPONSE

Typical Performance Curves $V_{SUPPLY} = \pm 15V$ (Continued)

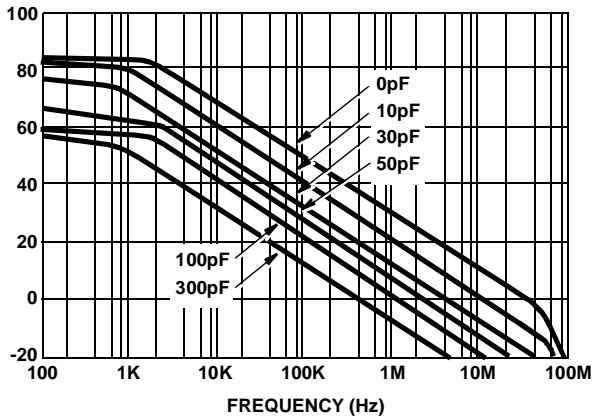

FIGURE 16. OPEN LOOP FREQUENCY RESPONSE FOR VARIOUS VALUES OF CAPACITORS FROM COMP PIN TO GROUND

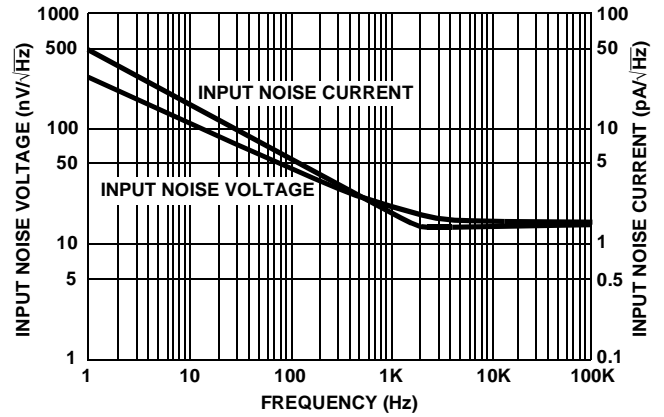

FIGURE 17. INPUT NOISE CHARACTERISTICS

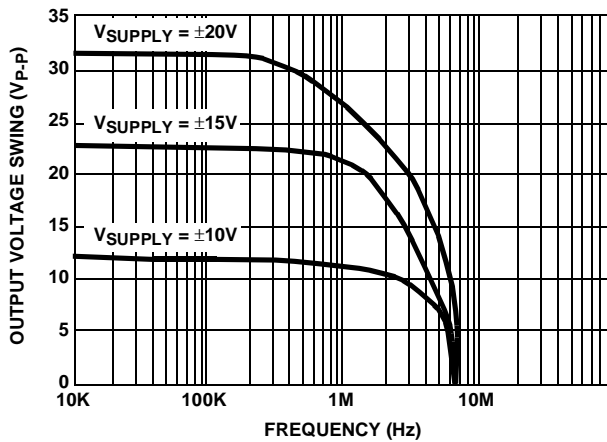

FIGURE 18. OUTPUT VOLTAGE SWING vs FREQUENCY

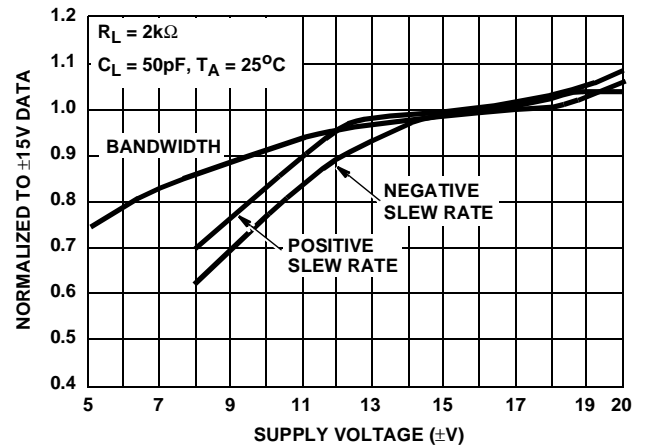

FIGURE 19. NORMALIZED AC PARAMETERS vs SUPPLY VOLTAGE

Die Characteristics

DIE DIMENSIONS:

67 mils x 57 mils x 19 mils
 1700 μ m x 1440 μ m x 483 μ m

METALLIZATION:

Type: Al, 1% Cu
 Thickness: 16k \AA \pm 2k \AA

SUBSTRATE POTENTIAL

Unbiased

PASSIVATION:

Type: Nitride (Si₃N₄) over Silox (SiO₂, 5% Phos.)
 Silox Thickness: 12k \AA \pm 2k \AA
 Nitride Thickness: 3.5k \AA \pm 1.5k \AA

TRANSISTOR COUNT:

40

PROCESS:

Bipolar Dielectric Isolation

Metallization Mask Layout

