



LC74411N, LC74411NE

PIP Controller

Preliminary

Overview

The LC74411N and LC74411NE are digital processing controllers for PIP (picture-in-picture) systems in TV sets and VCRs. These ICs incorporate three circuits, a multiplexed A/D converter, field memory, and a D/A converter, to implement the PIP digital processing block in a single chip.

Features

- Horizontal resolution: 450 pixels*
- Single-chip implementation of the three circuits required in a PIP digital processing block: A/D converter, field memory, and D/A converter circuits
- High image quality provided by vertical filtering
- IC bus adopted
- Built-in PLL circuit (requires an external low-pass filter)
- Supports NTSC and PAL, TV and VCR applications, and multi-format (NTSC and PAL) applications.
- External control function
- 8-bit D/A converter (PWM type): 6 pins
- General-purpose ports: 8 pins
- Sub-screen specifications
- Display on/off, frame/no frame, frame color switching, wipe function
- Display position - Specifiable as an 8-bit value for each of the horizontal and vertical directions.
- Size
 - Vertical reduction: 1/3, 1/4
 - Horizontal reduction: 1/3, 1/4
 - The horizontal size can be adjusted by adjusting the PLL divisor
 - The display area vertical and horizontal positions can be varied independently.
- Horizontal resolution (Y signal): about 190 dots
- Quantization: 6 bits
- Operating supply voltage LC74411NE : 5 V \pm 5%
LC74411N : 5 V \pm 10%
- Package
 - LC74411NE : QFP64E
 - LC74411N : DIP64S

Package Dimensions

unit: mm

3071-DIP64S

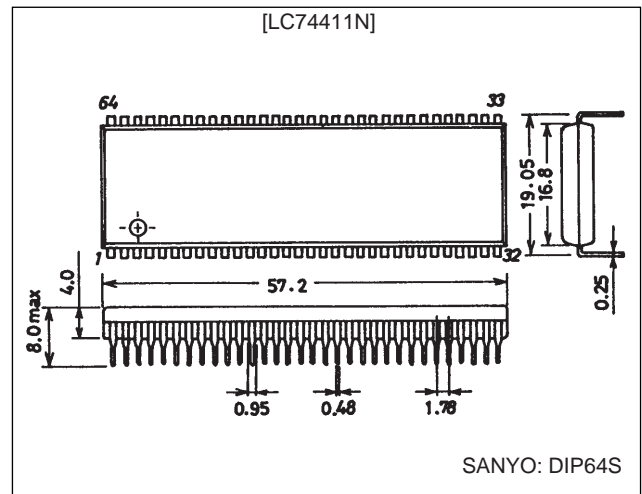

unit: mm

3159-QFP64E

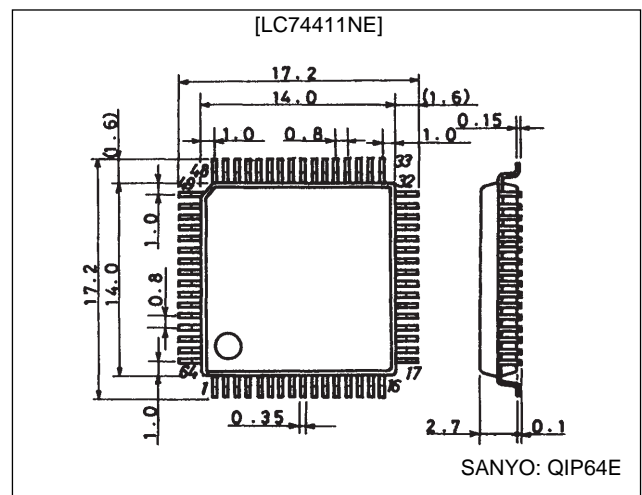

Note:

	D/A clock
Y	11.6 MHz
R-Y	2.9 MHz
B-Y	2.9 MHz

When the main screen synchronization PLL uses the standard value (PLL4 : 0 = 10110)

LC74411N, LC74411NE

Pin Assignments

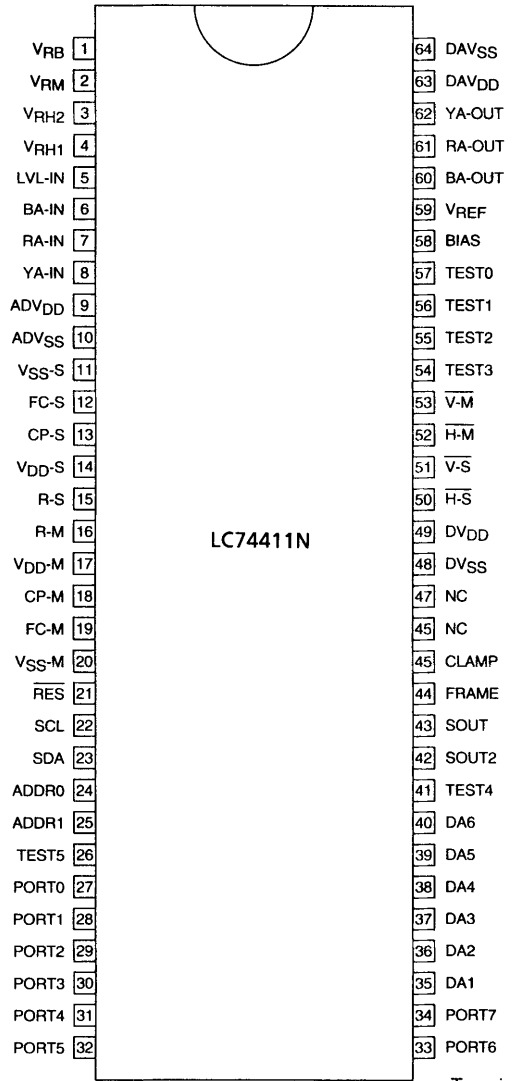

Top view

A06193

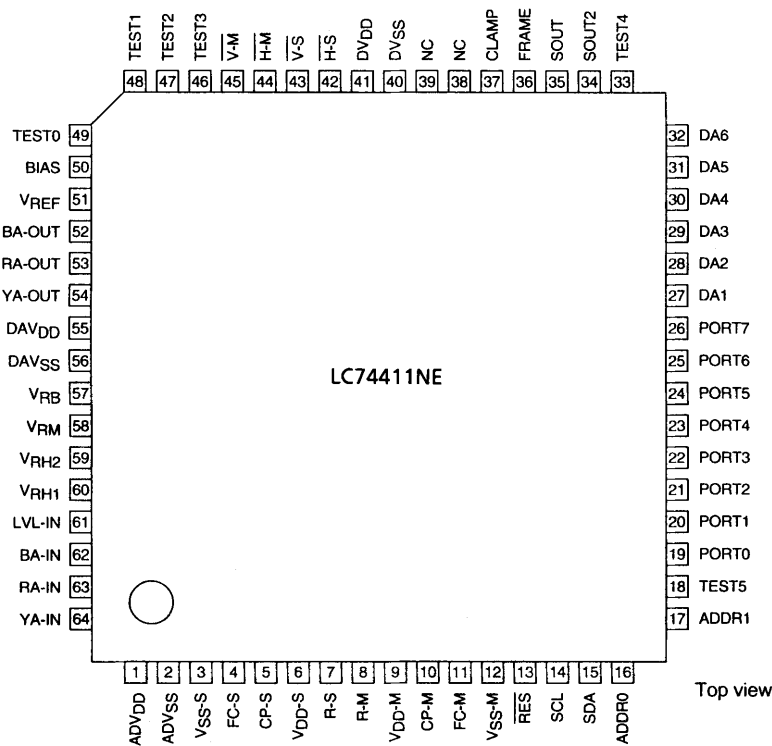

Top view

A06192

Block Diagram

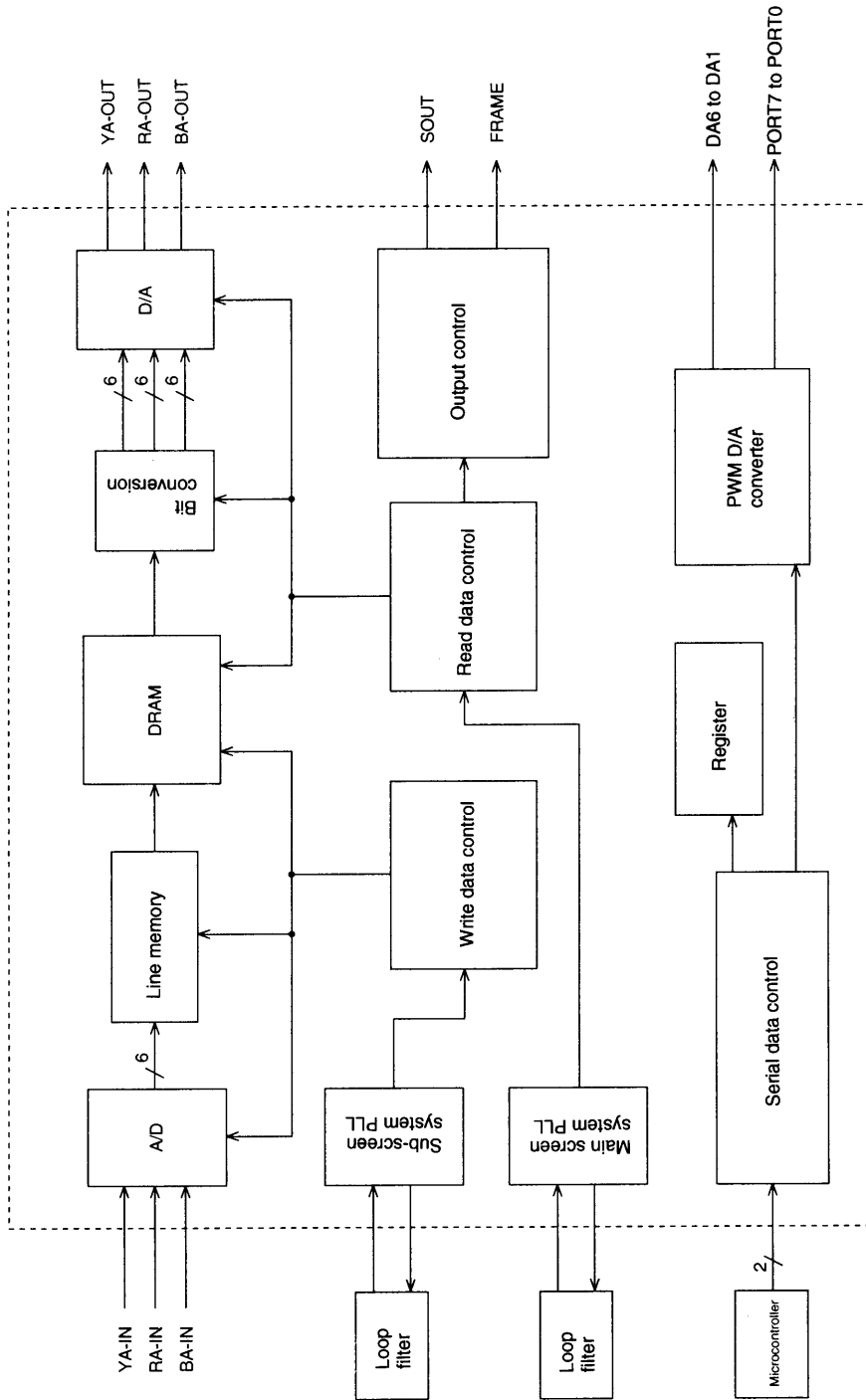

A06194

LC74411N and LC74411NE Based PIP System

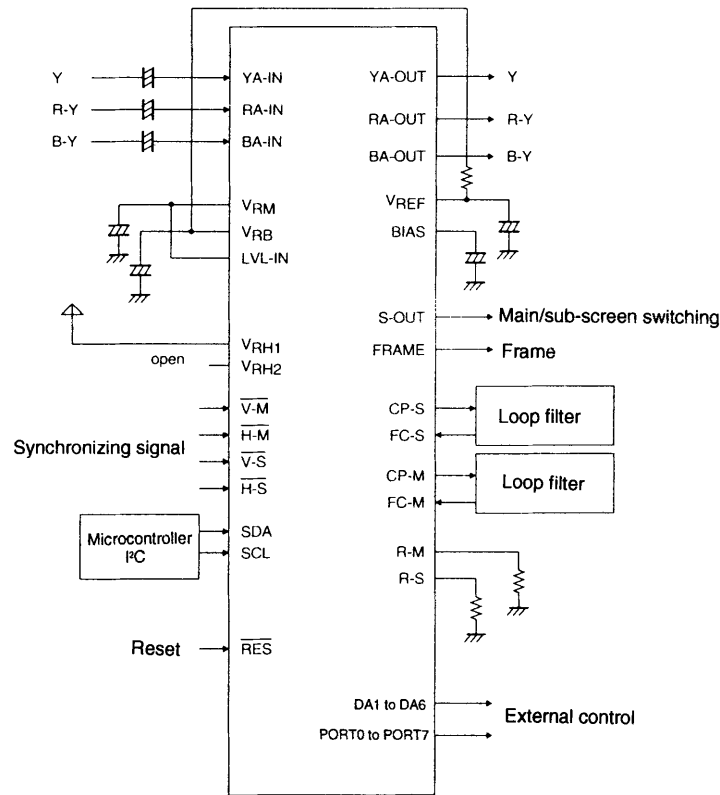

A06195

Function Overview

- Reduction sizes
 - Vertical : 1/3, 1/4; The vertical filter coefficient can be selected.
 - Horizontal: 1/3, 1/4; Variable at the PLL.
- Still image
 - Field still image
- Display position
 - Eight bits in each of the vertical and horizontal directions
- Frame
 - Frame or no frame can be selected.
 - Frame types differ according to the insertion method
 - Pin frame : A pin output that goes high at the frame position (for frame insertion by the application)
 - DAC frame : Frame overlapped onto the image signal. Four bits for each of the Y, R-Y, and B-Y signals.
- Wipe
 - Supports eleven different types of wipe.
- Blanking size
 - The vertical and horizontal directions can be specified independently (6 bits each)
 - Eleven form specification types
- Memory clear
 - The image data written to memory can be set to a fixed value.
 - Either 25% white or blue can be selected.
- Wide-aspect-ratio TV support
 - Aspect compensation function
- Support for NTSC, PAL, and multi-format systems
- External control function using the I²C bus
 - Incorporates six on-chip 8-bit D/A converter circuits
 - Provides eight general-purpose port pins.
- Wide range of settings and adjustments
 - Sub-screen displacement, color shifting, and other settings can be adjusted using the I²C bus.

Sub-Screen Size

The vertical and horizontal directions can be controlled independently.

- Vertical size
 - 1/3: Three scan lines are compressed to one.
 - 1/4: Four scan lines are compressed to one.
- Horizontal size
 - 1/3: A/D clock : D/A clock = 1:3
 - 1/4: A/D clock : D/A clock = 1:4
 - When 1/4 compression is used, the output data will be 3/4 of 1/3 of the input data.
 - Aspect ratio correction function
 - The horizontal size is adjusted by changing the VCO frequency (system clock).
 - This frequency can be changed from -30% to +30%.

Wipe Function

The WTOP, WBOT, WLEFT, and WRIGHT operations can be specified independently.

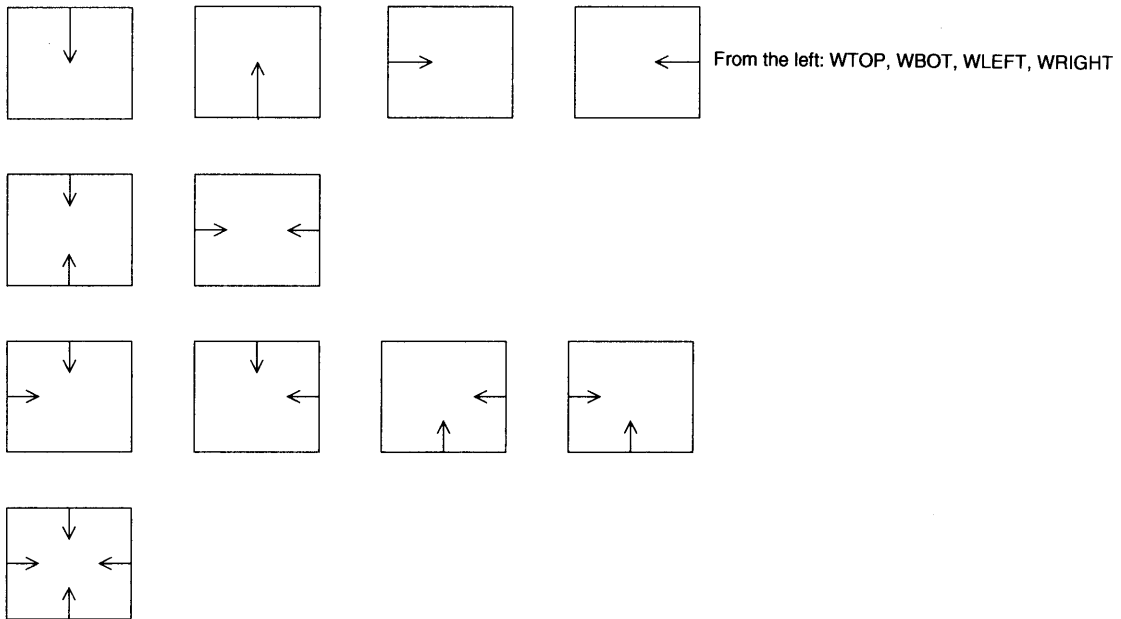

A06196

After the wipe function is set up, it operates automatically when the sub-screen is turned on or off.

Display Area Function

This function controls an area to be blanked.

The vertical and horizontal directions can be set independently.

The operating mode is set using the wipe function WTOP, WBOT, WLEFT, and WRIGHT parameters.

Application Examples

- Exclusion of the masked area from a letterbox screen

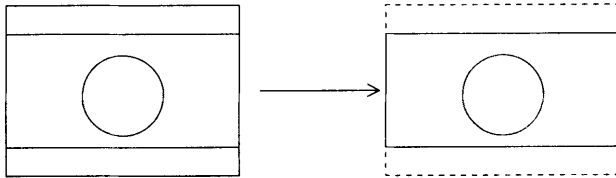

Note: The dotted lines indicate the area masked.

A06197

- Small display

Minimizes the hidden sections of the main screen.

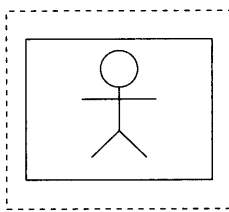

A06198

Internal Control Registers

Address \ Bit	MSB 7	6	5	4	3	2	1	LSB 0	Function
00H	SBY	STL	NT/PAL	D-BLUE	D-FIX	FILD	VDF-C0	POUT	Mode settings
01H	VP7	VP6	VP5	VP4	VP3	VP2	VP1	VP0	Vertical display position
02H	HP7	HP6	HP5	HP4	HP3	HP2	HP1	HP0	Horizontal display position
03H	0	SIZE-V	SIZE-H	DAFRM	YFC5	YFC4	YFC3	YFC2	Sub-screen size, frame color
04H	RFC5	RFC4	RFC3	RFC2	BFC5	BFC4	BFC3	BFC2	Frame color
05H	0	0	0	PLL4	PLL3	PLL2	PLL1	PLL0	PLL value
06H	PHP-M	PHP-S	WPE	WP-MOD	WTOP	WBOT	WLEFT	WRIGHT	Wipe
07H	0	0	VBS5	VBS4	VBS3	VBS2	VBS1	VBS0	Vertical display range
08H	0	0	HBS5	HBS4	HBS3	HBS2	HBS1	HBS0	Horizontal display range
09H	V-BLK	H-BLK	CL-AJ1	CL-AJ0	WV-AJ1	WV-AJ0	WH-AJ1	WH-AJ0	Fine adjustment
0AH	0	YC-AJ2	YC-AJ1	YC-AJ0	YCFAJ1	YCFAJ0	FM-AJ1	FM-AJ0	Fine adjustment
0BH	DAC1-7	DAC1-6	DAC1-5	DAC1-4	DAC1-3	DAC1-2	DAC1-1	DAC1-0	PWMDAC
0CH	DAC2-7	DAC2-6	DAC2-5	DAC2-4	DAC2-3	DAC2-2	DAC2-1	DAC2-0	PWMDAC
0DH	DAC3-7	DAC3-6	DAC3-5	DAC3-4	DAC3-3	DAC3-2	DAC3-1	DAC3-0	PWMDAC
0EH	DAC4-7	DAC4-6	DAC4-5	DAC4-4	DAC4-3	DAC4-2	DAC4-1	DAC4-0	PWMDAC
0FH	DAC5-7	DAC5-6	DAC5-5	DAC5-4	DAC5-3	DAC5-2	DAC5-1	DAC5-0	PWMDAC
10H	DAC6-7	DAC6-6	DAC6-5	DAC6-4	DAC6-3	DAC6-2	DAC6-1	DAC6-0	PWMDAC
11H	PORT7	PORT6	PORT5	PORT4	PORT3	PORT2	PORT1	PORT0	General-purpose ports

0: These bits must be set to 0.

LC74411N, LC74411NE

Register Data Overview

Address	Register	Notes
00H	SBY STL NT/PAL D-BLUE D-FIX FILD VDF-CO POUT	Standby mode (The PLL circuit operates.) Still image (Writes to internal memory are stopped.) Format selection (H: NTSC, L: PAL) Memory clear data selection (Valid when D-FIX = 1) (H: blue, L: gray) Memory clear (Holds the data written to memory at a fixed value.) Field display selection Vertical filter coefficient selection Sub-screen display on/off
01H	VP7 to 0	Sub-screen vertical position
02H	HP7 to 0	Sub-screen horizontal position
03H	SIZE-V SiZE-H DAFRM YFC5 to 2	Vertical compression specification H: 1/4, L: 1/3 Horizontal compression specification H: 1/4, L: 1/3 D/A converter frame on/off D/A converter frame color (Y)
04H	RFC5 to 2 BFC5 to 2	D/A converter frame color (R-Y) D/A converter frame color (B-Y)
05H	PLL4 to 0	PLL divisor value (The standard value is 10110.)
06H	PHP-M, S WPE WP-MOD WTOP to WRIGHT	Field discrimination inversion/noninversion Wipe or display area function enable Wipe or display area function selection (H: wipe) Wipe or display area function format specification
07H	VBS5 to 0	Display area range setting (vertical)
08H	HBS5 to 0	Display area range setting (horizontal)
09H	V-BLK, H-BLK CL-AJ1, 0 WV-AJ1, 0 WH-AJ1, 0	D/A converter frame output range specification (Normally set to 00B) A/D converter clamping potential adjustment (Can be monitored from the CLAMP pin.) Write vertical direction adjustment Write horizontal direction adjustment
0AH	YC-AJ2 to 0 YCFAJ1, 0 FM-AJ1, 0	C phase (with respect to Y) adjustment D/A converter frame C phase (with respect to Y) adjustment D/A converter frame left/right width adjustment
0BH	DAC1-7 to 0	External control D/A converter (8-bit PWM) data
0CH	DAC2-7 to 0	External control D/A converter (8-bit PWM) data
0DH	DAC3-7 to 0	External control D/A converter (8-bit PWM) data
0EH	DAC4-7 to 0	External control D/A converter (8-bit PWM) data
0FH	DAC5-7 to 0	External control D/A converter (8-bit PWM) data
10H	DAC6-7 to 0	External control D/A converter (8-bit PWM) data
11H	PORT7 to 0	Data for the general-purpose output ports

LC74411N, LC74411NE

Pin Functions

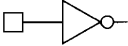
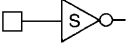
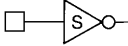
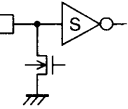
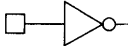
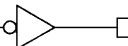
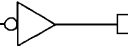
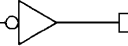
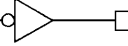
Pin No.		Pin	I/O	Connection	Function	Circuit type
64E	64S					
13	21	$\overline{\text{RES}}$	I	Initialization circuit	Reset	 A06199
45 44 43 42	53 52 51 50	$\overline{\text{V-M}}$ $\overline{\text{H-M}}$ $\overline{\text{V-S}}$ $\overline{\text{H-S}}$	I I I I	Synchronization separation circuit IC	Main screen vertical synchronizing signal (negative polarity) Main screen horizontal synchronizing signal (negative polarity) Sub-screen vertical synchronizing signal (negative polarity) Sub-screen horizontal synchronizing signal (negative polarity)	 A06200
14	22	SCL	I	Microcontroller	Serial clock	 A06201
15	23	SDA	I/O	Microcontroller	Serial data	 A06202
16 17	24 25	ADDR0 ADDR1	I I	DV _{SS} DV _{SS}	Must be connected to V _{SS} in normal operation.	 A06203
19 20 21 22 23 24 25 26	27 28 29 30 31 32 33 34	PORT0 PORT1 PORT2 PORT3 PORT4 PORT5 PORT6 PORT7	O O O O O O O O		General-purpose ports	 A06204
27 28 29 30 31 32	35 36 37 38 39 40	D/A1 D/A2 D/A3 D/A4 D/A5 D/A6	O O O O O O		PWM D/A converter outputs	 A06205
36 35 34	44 43 42	FRAME SOUT SOUT2	O O O	Analog circuits Analog circuits	Frame pulse output Main/sub-screen switching signal	 A06206
38 39 41 40	46 47 49 48	NC NC DV _{DD} DV _{SS}		No connection No connection Power supply Ground	Digital system power supply Digital system power supply	
64 63 62 61	8 7 6 5	YA-IN RA-IN BA-IN LVL-IN	I I I I	Analog circuits Analog circuits Analog circuits	Sub-screen analog input (Y) Sub-screen analog input (R-Y) Sub-screen analog input (B-Y) Preset voltage	
37	45	CLAMP	O		For use by user monitoring circuits A/D converter clamp pulse	 A06207

Notes: The 64E pin numbers refer to the LC74411NE and the 64S pin numbers refer to the LC74411N.
The letter "S" in an inverter indicates Schmitt input characteristics.

Continued on next page.

LC74411N, LC74411NE

Continued from preceding page.

Pin No.		Pin	I/O	Connection	Function	Circuit type
64E	64S					
60	4	V_{RH1}		Power supply or VRH2	Low-pass filter	
59	3	V_{RH2}		Open or VRH1	Low-pass filter	
58	2	V_{RM}		Capacitor	Oscillator range setting resistor	
57	1	V_{RB}		Capacitor and V_{REF}	Power supply	
1	9	ADV_{DD}		Power supply	Ground	
2	10	ADV_{SS}		Ground		
54	62	YA-OUT	O	Analog circuits	Sub-screen digital analog output (Y)	
53	61	RA-OUT	O	Analog circuits	Sub-screen digital analog output (R-Y)	
52	60	BA-OUT	O	Analog circuits	Sub-screen digital analog output (B-Y)	
51	59	V_{REF}	I	VRB	D/A converter analog setting pin	
50	58	BIAS	—	Capacitor		
55	63	DAV_{DD}		Power supply	Analog system power supply (D/A converter)	
56	64	DAV_{SS}		Ground		
10	18	CP-M	O	Low-pass filter	Charge pump output	
11	19	FC-M	I	Low-pass filter	Oscillator control voltage input	
8	16	R-M	—	Oscillator range setting resistor		
9	17	V_{DD-M}		Power supply	VCO power supply	
12	20	V_{SS-M}		Ground		
5	13	CP-S	O	Low-pass filter	Charge pump output	
4	12	FC-S	I	Low-pass filter	Oscillator control voltage input	
7	15	R-S	—	Oscillator range setting resistor		
6	14	V_{DD-S}		Power supply	VCO power supply	
3	11	V_{SS-S}		Ground		
49	57	TEST0	I			 A06208
48	56	TEST1	I			
47	55	TEST2	I			
46	54	TEST3	I	DV_{SS}	Testing (These pins must connected to DV_{SS} .)	
33	41	TEST4	I			
18	26	TEST5	I			

Specifications

Absolute Maximum Ratings at $T_a = 25 \pm 2^\circ\text{C}$, $V_{SS} = 0\text{ V}$

Parameter	Symbol	Conditions	Ratings	Unit
Maximum supply voltage	$V_{DD\text{ max}}$		-0.3 to +7.0	V
Maximum input voltage	$V_{IN\text{ max}}$		-0.3 to $V_{DD} + 0.3$	V
Maximum output voltage	$V_{OUT\text{ max}}$		-0.3 to $V_{DD} + 0.3$	V
Allowable power dissipation	$P_d\text{ max}$	LC74411NE	550	mW
		LC74411N	600	mW
Operating temperature	T_{opr}		-10 to +70	$^\circ\text{C}$
Storage temperature	T_{stg}		-55 to +125	$^\circ\text{C}$

Allowable Operating Ranges at $T_a = -10$ to $+70^\circ\text{C}$, $V_{SS} = 0\text{ V}$

Parameter	Symbol	Conditions	min	typ	max	Unit
Supply voltage	V_{DD}	LC74411NE	4.75	5.0	5.25	V
		LC74411N	4.5	5.0	5.5	V
Digital input high-level voltage	V_{IH}		$0.7V_{DD}$			V
Digital input low-level voltage	V_{IL}				$0.3V_{DD}$	V
Analog input voltage		The YA-IN, RA-IN, and BA-IN pins		$ADV_{DD} - V_{RB}$		Vp-p
Reference voltage	V_{REF}		2.7	$0.8V_{DD}$	V_{DD}	V

LC74411N, LC74411NE

Electrical Characteristics at $T_a = 25 \pm 2^\circ\text{C}$, $V_{DD} = 5\text{ V} \pm 5\%$ (LC74411NE), $V_{DD} = 5\text{ V} \pm 10\%$ (LC74411N), $V_{SS} = 0\text{ V}$

Parameter	Symbol	Conditions	min	typ	max	Unit
Output high-level voltage	V_{OH1}	$I_{OH} = -1\text{ mA}$, the CP-M and CP-S pins	$V_{DD}-1$			V
	V_{OH2}	$I_{OH} = -1\text{ mA}$, pins other than CP-M and CP-S	$V_{DD}-1$			V
Output low-level voltage	V_{OL1}	$I_{OL} = 1\text{ mA}$, the CP-M and CP-S pins			1.0	V
	V_{OL2}	$I_{OL} = 3\text{ mA}$, the SDA pin			0.4	V
	V_{OL3}	$I_{OL} = 2\text{ mA}$, pins other than the pins mentioned above			0.4	V
Quiescent current drain	I_{DDST}	$\overline{RES} = V_{SS}$, DC pin inputs, no output loads			10	μA
Reference voltage (M)	V_{RM}	When V_{RH1} is connected to ADV_{DD}		$0.9V_{DD}$		V
Reference voltage (B)	V_{RB}	When V_{RH1} is connected to ADV_{DD}		$0.8V_{DD}$		V
Input leakage current	I_{LK}	$V_I = V_{DD}, V_{SS}$	-1		+1	μA
Output leakage current	I_{OZ}	$V_I = V_{DD}, V_{SS}$, the CP-M and CP-S pins	-1		+1	μA
D/A converter output resistance	R_{DA}			300		Ω

Switching Characteristics at $T_a = 25 \pm 2^\circ\text{C}$, $V_{DD} = 5\text{ V} \pm 5\%$ (LC74411NE), $V_{DD} = 5\text{ V} \pm 10\%$ (LC74411N), $V_{SS} = 0\text{ V}$

Parameter	Symbol	Conditions	min	typ	max	Unit
Vertical synchronizing signal						
Pulse width	t_{VW}		1			μs
Rise time	t_{VR}				300	ns
Fall time	t_{VF}				300	ns
Horizontal synchronizing signal						
Pulse width	t_{HW}		1			μs
Rise time	t_{HR}				300	ns
Fall time	t_{HF}				300	ns
I ² C timing						
SCL frequency	t_{SCL}				100	kHz
Bus release time	t_{BUF}		4.7			μs
Start/hold	$t_{HD STA}$		4.0			μs
SCL low period	t_{LOW}		4.7			μs
SCL high period	t_{HIGH}		4.0			μs
Data hold time	$t_{HD DAT}$		0			μs
Data setup time	$t_{SU DAT}$		250			ns
Rise time	t_R				1000	ns
Fall time	t_F				300	ns
Stop setup time	$t_{SU STO}$		4.0			μs

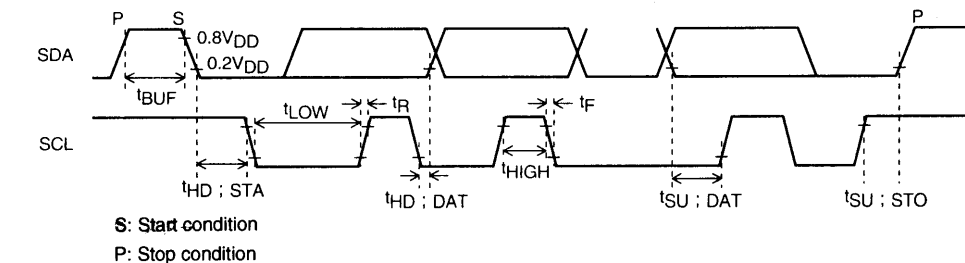

A06209

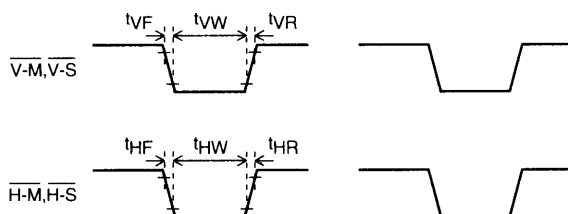

A06210

Sub-Screen Digital Processing Specifications

Item		NTSC ($f_H = 15734\text{Hz}$)	PAL ($f_H = 15625\text{Hz}$)
A/D converter sampling	Order	Y, R-Y, Y, B-Y, Y-, Y-, Y-,	
	Frequency	480 f_H	
	f_T (MHz)	7.552	7.500
	Y only	240 f_H	
	f_{TY}	3.776	3.750
	R-Y only	60 f_H	
f_{TR}	0.944	0.938	
B-Y only	60 f_H		
f_{TB}	0.944	0.938	
Number of bits in quantization		6 bits	
D/A converter clock (MHz)*1	Y signal	736 f_H	
	f_{CY}	11.58	11.50
	R-Y signal	184 f_H	
	f_{CR}	2.895	2.875
B-Y signal	184 f_H		
f_{CB}	2.895	2.875	
Write	Number of horizontal bits	288	
	Y only	192	
	R-Y only	48	
	B-Y only	48	
	Number of vertical lines	73	85
Readout display*2	Number of horizontal bits	268	
	Y only	180	
	R-Y only	44	
	B-Y only	44	
	Number of vertical lines	72	84

Note: 1. When the PLL divisor has its standard value (PLL4:0 = 10110).

2. Target values are shown. (The number of horizontal bits varies with, for example, the frame width adjustment.)

Initialization

(1) $\overline{\text{RES}}$ pin: Reset

The RES pin must be held low when power is first applied with the timing shown in the figure.

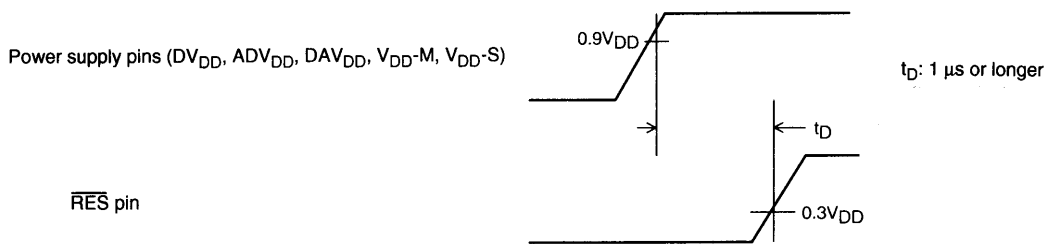

A06211

(2) Internal control registers

After a reset, the chip goes to the standby state ($\text{SBY} = \text{high}$). When developing the microcontroller software, that software must be designed so that it transmits data for all registers. Also note that data values of zero (0) must be sent for the control registers that have '0' entries in the control register table.

I²C Control

Data format

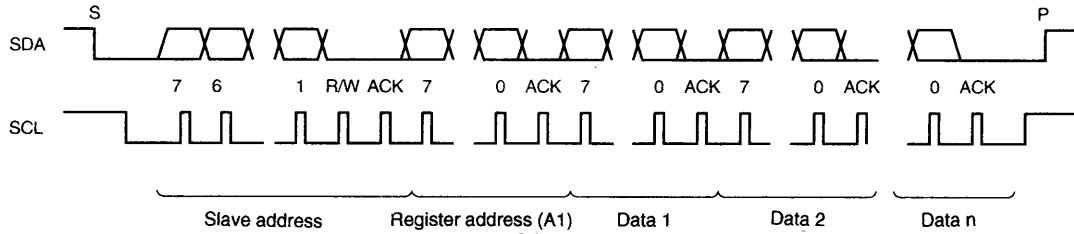

Data 1 is stored at register address A1. Data 2 is stored at register address A1 + 1, i.e., the address given by incrementing A1. If the address exceeds 11H, it wraps to 00H.

Slave address:

A6	A5	A4	A3	A2	A1	A0	R/W
0	0	1	0	0	1	1	0

Synchronizing Signal Input

• Sync separation

The LC74411N and LC74411NE require sync separated (including AFC processing) V and H signals for both the main and sub-screen. Since V is used for field discrimination and H is used as the PLL reference signal, these signals must be provided reliably.

- The H-M and H-S pin inputs are assumed to be delayed about 1 μs from the video signal’s horizontal synchronizing signal and set to standard values.
- Equalizing pulses must be excluded.
- Since noise on the synchronizing signal will disrupt the display, these lines should be placed carefully.
- If the synchronizing signal is unstable, the sub-screen display may be disrupted. We recommend turning off sub-screen display in such cases.

• Field discrimination circuit

Since the circuit discriminates based on the phase difference between the falling edges of the H and L signals, these signals must be provided with the timing shown in the figure below.

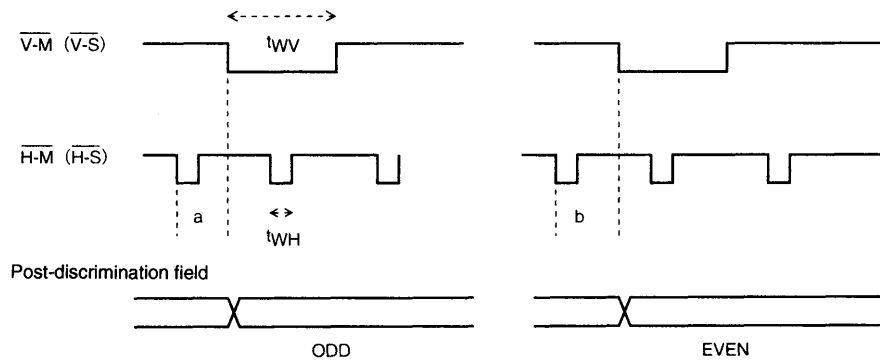

The periods a and b must be in the following ranges:
 a = 0.02 to 0.40 H
 b = 0.60 to 0.98 H
 The synchronizing signal pulse widths must meet the following conditions:
 $t_{WV} > 1 \mu s$
 $t_{WH} > 1 \mu s$

Clamp Pulses

• A/D converter clamping

Since clamp pulses are output to the built-in A/D converter with the timing shown in the figure below, they are set up to fall in the pedestal range. The clamp pulses can be monitored at the CLAMP pin. On a reset or in standby mode, the H-S input signal becomes positive polarity and is output without change.

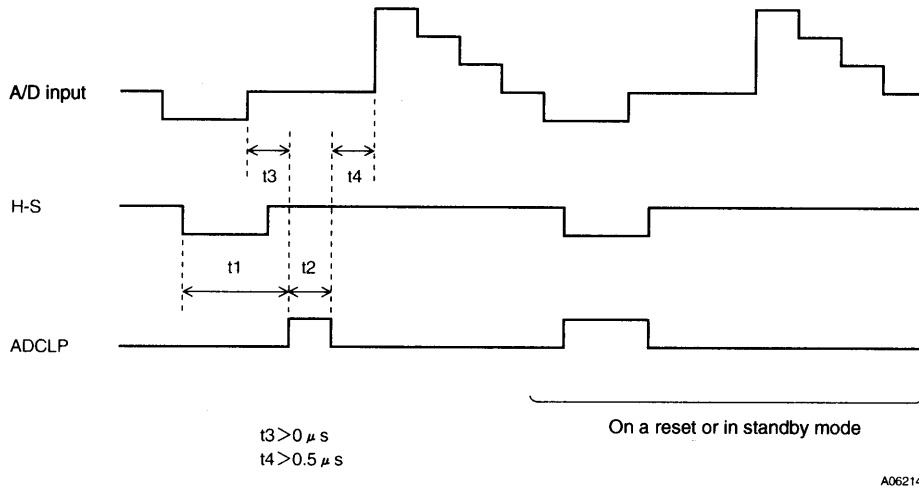

A06214

• D/A converter clamp

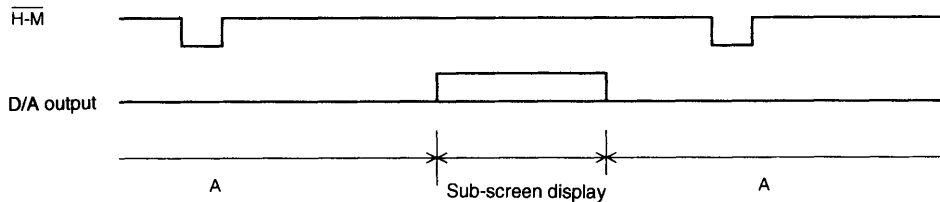

A06215

Digital data in the area A
 Y D/A: 00000
 R-Y D/A: 100000
 B-Y D/A: 1000000

Applies a clamp on the main screen horizontal synchronizing signal.

External Control Output Blanking

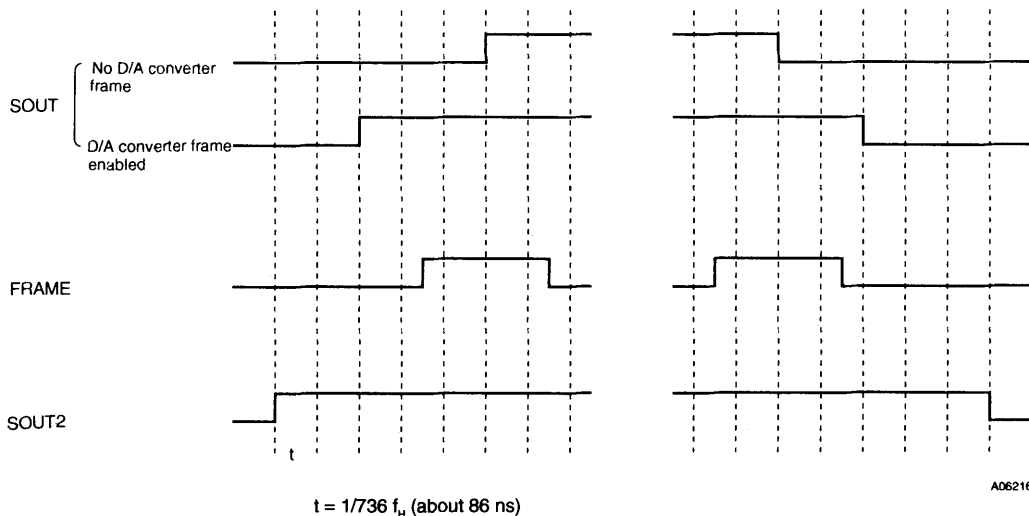

A06216

Note: FRAME is only output when there is not D/A converter frame.

- No products described or contained herein are intended for use in surgical implants, life-support systems, aerospace equipment, nuclear power control systems, vehicles, disaster/crime-prevention equipment and the like, the failure of which may directly or indirectly cause injury, death or property loss.
- Anyone purchasing any products described or contained herein for an above-mentioned use shall:
 - ① Accept full responsibility and indemnify and defend SANYO ELECTRIC CO., LTD., its affiliates, subsidiaries and distributors and all their officers and employees, jointly and severally, against any and all claims and litigation and all damages, cost and expenses associated with such use:
 - ② Not impose any responsibility for any fault or negligence which may be cited in any such claim or litigation on SANYO ELECTRIC CO., LTD., its affiliates, subsidiaries and distributors or any of their officers and employees jointly or severally.
- Information (including circuit diagrams and circuit parameters) herein is for example only; it is not guaranteed for volume production. SANYO believes information herein is accurate and reliable, but no guarantees are made or implied regarding its use or any infringements of intellectual property rights or other rights of third parties.

This catalog provides information as of September, 1996. Specifications and information herein are subject to change without notice.