

ILC6377

0.5A, 300kHz, SO-8 PWM/PFM Step Down Converter with Shutdown



General Description

The ILC6377 is a 95% efficient, 300kHz step-down DC-DC converter in an SO-8 package; capable of delivering 500mA output current. The device is also capable of driving an external FET for higher output current applications.

The ILC6377 uses a unique p-channel architecture with built-in charge pump to maintain low on-resistance, even at low input voltages. At high or normal currents the ILC6377 operates in PWM mode with 300kHz operating frequency. When the load current drops and the device hits approximately 17% duty cycle, it automatically switches over to PFM or pulse skipping mode. PFM (pulse frequency modulation) mode of operation extends efficiency at light loads.

Start-up is controlled via an external soft-start capacitor. The device will automatically re-enter start-up mode when an output current overload condition is sensed; thus providing automatic short-circuit protection. Voltage lockout prevents faulty operation below the minimum operating voltage level. In shutdown, the ILC6377 consumes only 1.5mA current.

The ILC6377SO-XX offers fixed 3.3V or 5V output while ILC6377SO-Adj allows adjustable output. Both versions of ILC6377 are available in an SO-8 surface mount package.

Features

- ◆ $\pm 2.5\%$ accurate output voltages
- ◆ Guaranteed 500mA output current
- ◆ 95% efficiency
- ◆ 55mA no load battery input current
- ◆ 1.5mA shutdown current
- ◆ Built in short circuit and overcurrent protection
- ◆ Undervoltage lockout and soft-start
- ◆ External transistor drive available for higher lout
- ◆ 300kHz operation
- ◆ Automatic switchover to PFM mode at low currents for longest battery life
- ◆ Fixed 3.3V or 5V or adjustable output
- ◆ SO-8 package

Applications

- ◆ Cellular Phones
- ◆ Palmtops and PDAs
- ◆ Portable Instrumentation
- ◆ Buck Converter for Industrial / Networking Applications

Block Diagram

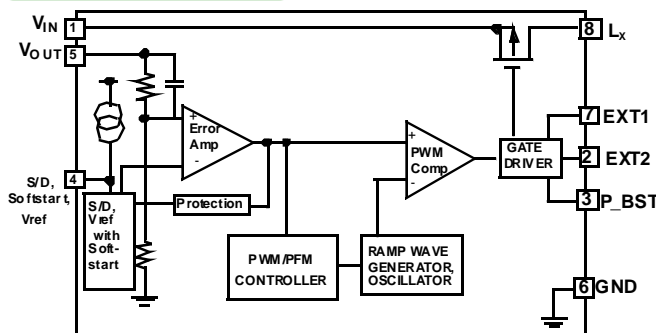

Pin Package Configurations

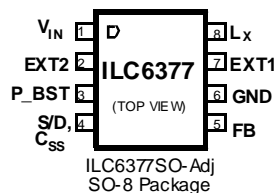
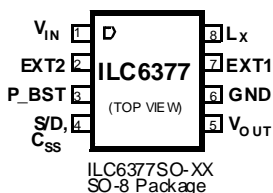

Ordering Information

| | |
|---------------|---|
| ILC6377SO-33 | 3.3V, 300 kHz step-down PWM/PFM converter |
| ILC6377SO-50 | 5V, 300 kHz step-down PWM/PFM converter |
| ILC6377SO-Adj | Adjustable, 300 kHz step-down PWM/PFM converter |

Pin Description

| Pin | Symbol | Function |
|-----|---------------------------|--|
| 1 | V_{IN} | Power Supply |
| 2 | EXT2 | External gate drive pin (low when P-Ch FET is ON) |
| 3 | P-BST | P-Ch gate boost |
| 4 | S/D, Softstart, V_{ref} | Shutdown, also soft-start capacitor pin and V_{ref} output |
| 5 | V_{OUT}/FB | Output voltage sense pin for ILC6377SO-XX; 1V feedback for ILC6377SO adj |
| 6 | GND | Ground connection |
| 7 | EXT1 | External gate drive pin (low when P-Ch FET is on) |
| 8 | L_x | Inductor switch pin |

Absolute Maximum Ratings ($T_A=25^\circ\text{C}$)

| Parameter | Symbol | Ratings | Units |
|--|-----------------------|-------------------------------------|------------------|
| V_{IN} Input Voltage Pin | V_{IN} | -0.3 to +12 | V |
| V_{OUT} Pin (ILC6370SO-XX) FB Pin (ILC6377SO-Adj) | V_{OUT} V_{FB} | -0.3 to +12 -0.3 to $V_{IN} +12$ | V |
| Voltage on L_X pin | V_{LX} | $V_{IN} - V_{LX} = 0.3$ to +12 | V |
| Peak Switch Current on L_X pin | I_{LX} | 700 | mA |
| Voltage on P_BST pin | V_{DP_BST} | $V_{IN} - V_{P_BST} = 0.3$ to +12 | V |
| Current EXT1, EXT2 pins | I_{EXT1}, I_{EXT2} | ± 50 | mA |
| Voltage on all other pins | ~ | -0.3 to V_{IN} | V |
| Continuous Total Power Dissipation | P_D | 500 | mA |
| Operating Ambient Temperature | T_{OPR} | -30~+80 | $^\circ\text{C}$ |
| Storage Temperature | T_{STG} | -40~+125 | $^\circ\text{C}$ |

Electrical Characteristics ILC6377SO-33

Unless Otherwise specified all limits are at $V_{OUT} = 3.3\text{V}$, $V_{IN} = 4\text{V}$, $F_{OSC}=300\text{kHz}$, $I_{OUT} = 130\text{mA}$, $T_A = 25^\circ\text{C}$. Circuit configuration of figure 1.

| Parameter | Symbol | Conditions | Min | Typ | Max | Units |
|------------------------------|--------------|---|-------|-------|-------|---------------|
| Output Voltage | V_{OUT} | | 3.218 | 3.300 | 3.383 | V |
| Input Voltage | V_{IN} | | | | 10 | V |
| Output Current | I_{OUT} | | 500 | 600 | | mA |
| Input Current Supply | I_{IN} | $V_{IN} 3.5\text{V}$, No Loads | | 55 | 86 | μA |
| Shutdown Current | $I_{S/D}$ | $V_{S/D} = 0\text{V}$ | | 1.5 | 2.5 | μA |
| L_X Switch On - Resistance | $R_{ds(on)}$ | Open Loop Measurement, $V_{S/D} = V_{IN}$, $V_{LX} = V_{IN} - 0.4\text{V}$, $V_{OUT} = 3\text{V}$ | | 0.64 | 0.85 | Ω |
| L_X Switch Leakage Current | I_{LXL} | Open Loop Measurement, $V_{OUT} = V_{IN}$, $V_{LX} = 0\text{V}$ | | | 2.0 | μA |
| Oscillator Frequency | F_{OSC} | Measurement Waveform at EXT pin $V_{IN} = 3.6\text{V}$ $I_{OUT} = 20\text{mA}$ | 255 | 300 | 345 | kHz |
| Max Duty Cycle | MAXDTY | | | 100 | | % |
| PFM Duty Cycle | PFMDTY | No Load | 10 | 17 | 25 | % |
| Efficiency | EFFI | | | 95 | | % |
| Undervoltage Lockout | V_{UVLO} | Minimum V_{IN} when V_{ref} does not start up | 1 | | 1.8 | V |
| Soft-Start Time | T_{SS} | V_{ref} rises to 0V from 0.9V | 6.0 | 10.0 | 16.0 | msec |

Electrical Characteristics ILC6377SO-33

Unless Otherwise specified all limits are at $V_{OUT} = 3.3V$, $V_{IN} = 4V$, $F_{OSC} = 300kHz$, $I_{OUT} = 130mA$, $T_A = 25^\circ C$. Circuit configuration of figure 1.

| Parameter | Symbol | Conditions | Min | Typ | Max | Units |
|------------------------------|-----------------|---|------|-----|-----|----------|
| Internal Protection Time | T_{PRO} | Time from $V_{OUT} = 0V$ to $V_{S/D}$ going low | 3.0 | 5.0 | 8.0 | Msec |
| Shutdown Input Voltage | V_{SD} | High = Regulator "ON" Low = Regulator "OFF" | 0.65 | | 0.2 | V |
| EXT1, EXT2 Hi On-Resistance | $REX_{t_{HI}}$ | 3V applied to V_{OUT} with no external components | | 3.5 | 47 | Ω |
| EXT1, EXT2 Low On-Resistance | $REX_{t_{LOW}}$ | 3.6V applied to V_{OUT} with no external components | | 29 | 37 | Ω |

Electrical Characteristics ILC6377SO-50

Unless Otherwise specified all limits are at $V_{OUT} = 5.0V$, $V_{IN} = 6V$, $F_{OSC} = 300kHz$, $I_{OUT} = 200mA$, $T_A = 25^\circ C$. Circuit configuration of figure 1.

| Parameter | Symbol | Conditions | Min | Typ | Max | Units |
|------------------------------|-----------------|--|-------|-------|-------|----------|
| Output Voltage | V_{OUT} | | 4.875 | 5.000 | 5.125 | V |
| Input Voltage | V_{IN} | | | | 10 | V |
| Output Current | I_{OUT} | | 500 | 600 | | mA |
| Input Supply Current | I_{IN} | $V_{IN} = 5.25V$, No Load | | 71 | 110 | μA |
| Shutdown Current | $I_{S/D}$ | $V_{S/D} = 0V$ | | 1.5 | 2.5 | μA |
| L_X Switch On-Resistance | $R_{ds(on)}$ | Open Loop Measurement, $V_{S/D} = V_{IN}$, $V_{LX} = V_{IN} - 0.4V$, $V_{OUT} = 4.5V$ | | 0.44 | 0.58 | Ω |
| L_X Switch Leakage Current | I_{LXL} | Open Loop Measurement, $V_{OUT} = V_{IN}$, $V_{LX} = 0V$ | | | 2.0 | μA |
| Oscillator Frequency | F_{OSC} | Measure Waveform at EXT pin $V_{IN} = 5.3V$ $I_{OUT} = 20mA$ | 255 | 300 | 345 | kHz |
| Max Duty Cycle | MAXDTY | | | 100 | 25 | % |
| PFM Duty Cycle | PFMDTY | No Load | 10 | 17 | | % |
| Efficiency | EFFI | | | 95 | 1.8 | % |
| Undervoltage Lockout | V_{UVLO} | Minimum V_{IN} when V_{ref} does not start up | 1 | | 16.0 | V |
| Soft-Start Time | T_{SS} | V_{ref} rises to 0V from 0.9V | 6.0 | 10.0 | 8.0 | msec |
| Internal Protection Time | T_{PRO} | Time from $V_{OUT} = 0V$ to $V_{S/D}$ going low | 3.0 | 5.0 | 0.2 | msec |
| Shutdown Input Voltage | $V_{S/D}$ | High = Regulator "ON" Low = Regulator "OFF" | 0.65 | | | V |
| EXT1, EXT2 Hi On-Resistance | $REX_{t_{HI}}$ | Open Loop Measurement | | 24 | 32 | Ω |
| EXT1, EXT2 Low On-Resistance | $REX_{t_{LOW}}$ | Open Loop Measurement | | 20 | 26 | Ω |

Electrical Characteristics ILC6377SO-Adj

Unless Otherwise specified all limits are at V_{OUT} programmed to 5.0V, $V_{IN} = 6V$, $F_{OSC} = 300kHz$, $I_{OUT} = 200mA$, $T_A = 25^{\circ}C$. Circuit configuration of figure 1.

| Parameter | Symbol | Conditions | Min | Typ | Max | Units |
|------------------------------|--------------|--|------|-------|-------|----------|
| Feedback Voltage (pin5) | V_{FB} | | .995 | 1.000 | 1.015 | V |
| Input Voltage | V_{OUT} | $R_{FB1} + R_{FB2} \leq 2M\Omega$ | 3 | | 8 | V |
| Output Current | I_{OUT} | | 500 | 600 | | mA |
| Input Supply Current | I_{IN} | $V_{IN} = 5.25V$, No Load | | 71 | 110 | μA |
| Shutdown Current | $I_{S/D}$ | $V_{S/D} = 0V$ | | 1.5 | 2.5 | μA |
| L_X Switch On-Resistance | $R_{ds(on)}$ | Open Loop Measurement, $V_{S/D} = V_{IN}$, $V_{LX} = V_{IN} - 0.4V$, $V_{OUT} = 4.5V$ | | 0.44 | 0.58 | Ω |
| L_X Switch On-Resistance | I_{LXL} | Open Loop Measurement, $V_{OUT} = V_{IN}$, $V_{LX} = 0V$ | | | 2.0 | μA |
| Oscillator Frequency | F_{OSC} | Measure Waveform at EXT pin $V_{IN} = 5.3V$ $I_{OUT} = 20mA$ | 255 | 300 | 345 | kHz |
| Max Duty Cycle | MAXDTY | | | 100 | | % |
| PFM Duty Cycle | PFMDTY | No Load | 10 | 17 | 25 | % |
| Efficiency | EFFI | | | 95 | | % |
| Undervoltage Lockout | V_{UVLO} | Minimum V_{IN} when V_{ref} does not start up | 1 | | 1.8 | V |
| Soft-Start Time | T_{SS} | V_{ref} rises to 0V from 0.9V | 6.0 | 10.0 | 16.0 | msec |
| Internal Protection Time | T_{PRO} | Time from $V_{OUT} = 0V$ to $V_{S/D}$ going low | 3.0 | 5.0 | 8.0 | msec |
| Shutdown Input Voltage | $V_{S/D}$ | High = Regulator "ON" Low = Regulator "OFF" | 0.65 | | 0.2 | V |
| EXT1, EXT2 Hi On-Resistance | $REXt_{HI}$ | Open Loop Measurement | | 24 | 32 | Ω |
| EXT1, EXT2 Low On-Resistance | $REXt_{LOW}$ | Open Loop Measurement | | 20 | 26 | Ω |

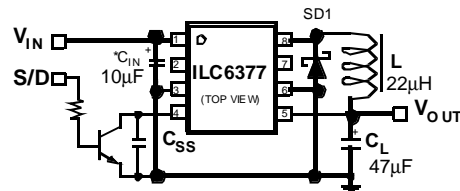

Fig. 1: Typical step-down DC-DC converter application

SD1 : MA735 Schottky Diode (MATSUSHITA)
 C_L : 10V/47µF Tantalum Capacitor (NICHICON, F93)
 C_{SS} : 4700pF Ceramic Capacitor
 C_{IN} : 16V / 10µF Tantalum Capacitor (NICHICON, F93)

Figure 2 shows a typical fixed output voltage step-down DC-DC converter application circuit for ILC6377SO-XX

External component selection

Proper selection of external components is important for achieving high performance. The output inductor selected should have low DC resistance on the order of 0.2W or less and saturation current rating of 1A or higher. Recommended inductors are Sumida CD54 (22mH, 0.18W max DC resistance) or Coilcraft DO3308P-223 (22mH, 0.18W max DC resistance) or equivalent.

The catch diode should be a schottky diode with low forward drop and rated at 1A or greater current, MA735 or it's equivalent is recommended.

Input and output capacitors should be tantalum capacitors with low equivalent series resistance (ESR) and voltage rating higher than the actual application.

Soft-start

Pin 4 of ILC6377 functions as the soft-start pin as well as the shutdown pin. A soft-start capacitor (from pin 4 to ground) controls the rate at which the power supply starts up; thus preventing large overshoots at the output as well as large in-rush current. The value for C_{SS} should be 100pF or greater.

Shutdown

The ILC6377 is placed in shutdown mode by taking pin 4 to ground. In shutdown, the quiescent current of the device is under 2mA. When using the shutdown feature, pin 4 must be driven from an open collector or open drain output without employing an external pull-up resistor, as shown in figure 2. Since pin 4 is also used to charge an external capacitor for soft-start, this pin should not be driven from a push-pull CMOS type output.

Over-current and short-circuit protection

In the event of an over-current or short-circuit condition, the ILC6377 cycles the soft-start pin in a hiccup mode to provide fault protection. When the output voltage decreases due to overload, the ILC6377 will operate continuously at the maximum duty cycle. If the period of maximum duty cycle operation exceeds T_{PRO} (typically 5 msec), pin 4 will be pulled low; thus discharging the external soft-start capacitor C_{SS} . This action inhibits the regulator's PWM action. Next, the ILC6377's soft-start circuitry starts recharging C_{SS} and initiates a controlled start-up. If the overload condition continues to exist, the above sequence of events will repeat; thus continuing to cycle the soft-start function.

Note that very little power is dissipated with this method of fault protection versus constant current limit protection. Even though the internal power MOSFET is pulsed on and off at high peak current, the DC current is low; thus leading to low power dissipation even under short-circuit conditions.

Keep in mind that the duration of maximum duty cycle condition is used to trigger the ILC6377's fault protection circuit. As such, a small input-output ($V_{IN} - V_{OUT}$) differential voltage may trigger the device's fault protection circuitry even at low output current.

Undervoltage Lockout

The undervoltage lockout feature prevents faulty operation by disabling the operation of the regulator when input voltage is below the minimum operating voltage, V_{UVLO} . When the input voltage is lower than V_{UVLO} the device disables the internal P-channel MOSFET and provides "high" output at both EXT1 and EXT2 outputs.

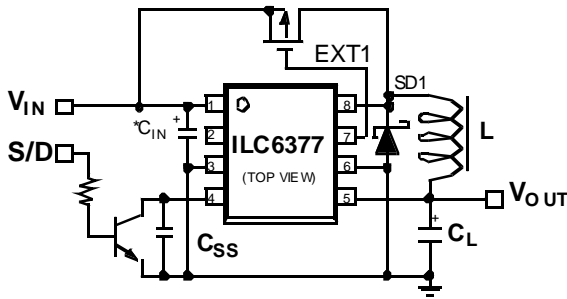

Fig. 2: 1Amp output current application using external MOSFET

The EXT1 and EXT2 pins are provided so as to drive external transistors; thus allowing design flexibility. The EXT output drive signal has the same timing as the gate drive to the internal P-channel MOSFET i.e. EXT output is low as long as the internal MOSFET is on. Both EXT1 and EXT2 pins are capable of driving 1000pF gate capacitance. For example, a high output current application circuit using an external P-channel MOSFET is shown in figure 2.

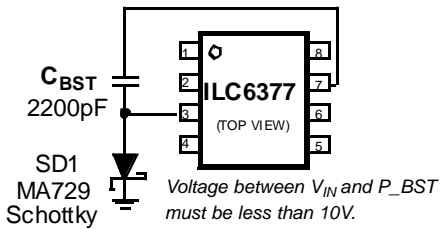
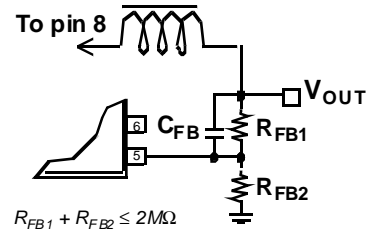

Fig. 3: P-Channel Negative

P-Channel Boost Circuit

The ILC6377 includes a unique P-Channel MOSFET architecture with built-in charge pump to maintain low on-resistance even at low input voltages. As shown in figure 3, a 2200pF ceramic capacitor and a schottky diode (MA729 or equivalent) allows the gate voltage of the internal P-Channel MOSFET to be driven negative; thus reducing the switch on-resistance. This technique can be employed to increase efficiency at low input voltages and high output currents.

Note that the voltage between VIN and P_BST should not exceed 10V, otherwise damage to the device may occur. For high input voltage applications the schottky diode should be replaced by a low voltage zener diode so that the P_BST pin is clamped to a safe negative voltage.



$$C_{FB} \text{ chosen so that } 1\text{kHz} < \frac{1}{2 \times \pi \times C_{FB} \times R_{FB1}} < 20\text{kHz}$$

Fig. 4: Adjustable output using ILC6377SO-Adj
(Note: rest of circuit is same as figure 1)

Adjustable Output (ILC6377SO-Adj)

For adjustable output voltage ILC6377SO-Adj should be used. All connections to the ILC6377SO-Adj are the same as ILC6377SO-XX, except for the feedback voltage divider network shown in figure 4. The output voltage, VOUT, can be calculated from the following equation:

$$V_{OUT} = V_{FB} (1 + R_{FB1}/R_{FB2}),$$

where V_{FB} is approximately 1V and
R_{FB1} + R_{FB2} < 2MΩ

The feedback compensation capacitor should be chosen such that the pole frequency f is between 1kHz and 20kHz:

$$1\text{kHz} < \frac{1}{2 \times \pi \times C_{FB} \times R_{FB1}} < 20\text{kHz}$$

The pole frequency should generally be set at 5kHz. The value of C_{FB} calculated from the above equation may require some adjustment depending on the output inductor (L) and output capacitor (CL) values chosen.

Example for 3V output :

- R_{FB1} = 400kΩ
- R_{FB2} = 200kΩ
- C_{FB} = 100pF

PC Board Layout

As with all switching DC-DC converter designs, good PC board layout is critical for optimum performance. **The heavy lines indicated in figure 1 schematic should be wide printed circuit board traces and should be kept as short as is practical.** A large ground plane with as much copper area as is allowable should be used. All external components should be mounted as close to the IC as possible. For ILC6377SO-Adj, the feedback resistors and their associated wiring should be kept away from the inductor location and the vicinity of inductive flux.

Typical Performance Characteristics

General conditions for all curves: Circuit of figure 1; L = 20μH (Sumida, CD54), C_{IN} = 47μF (tantalum) with 0.1μF (ceramic), C_L = 47μH (tantalum) MA735 (Matsushita) schottky diode, C_{SS} = 4700pF (ceramic), T_A = 25°C unless otherwise noted.

Output Voltage vs. Output Current

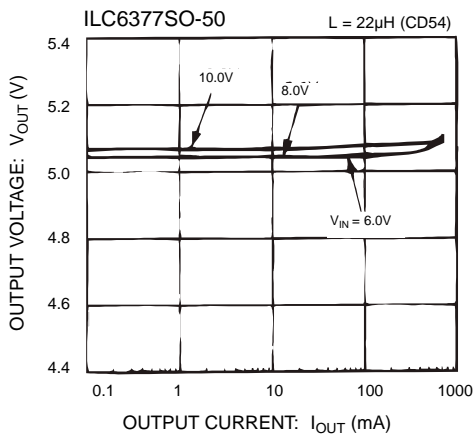
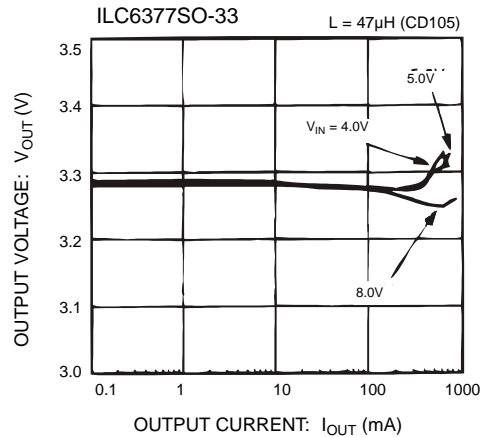
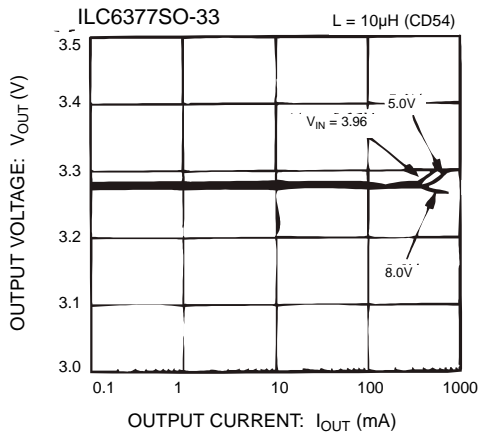
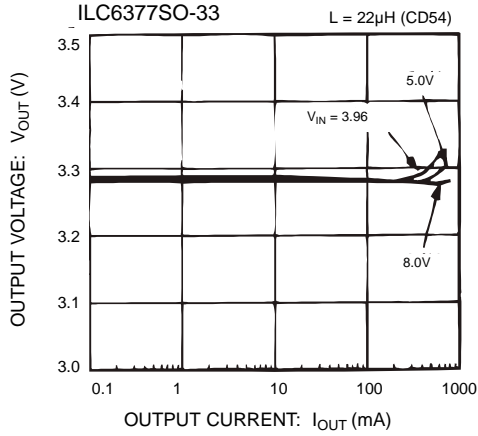

Typical Performance Characteristics

General conditions for all curves: Circuit of figure 1; L = 20μH (Sumida, CD54), C_{IN} = 47μF (tantalum) with 0.1μF (ceramic), C_L = 47μH (tantalum) MA735 (Matsushita) schottky diode, C_{SS} = 4700pF (ceramic), T_A = 25°C unless otherwise noted.

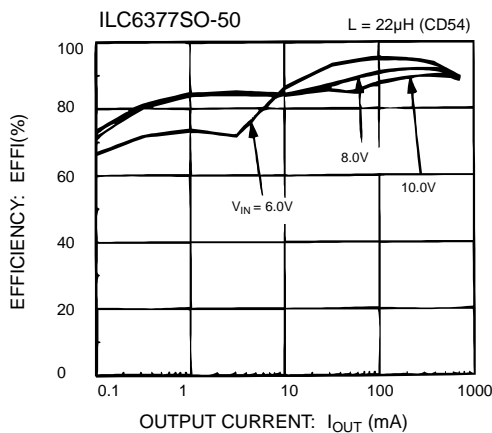
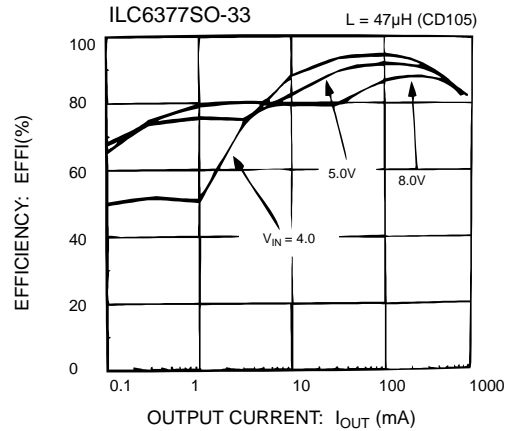
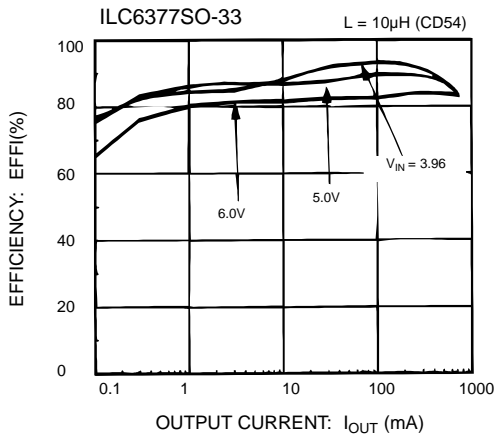
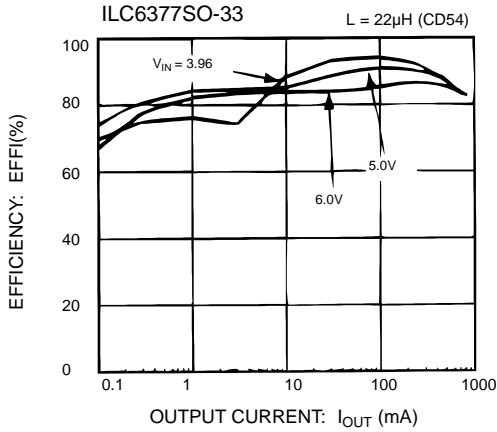

Typical Performance Characteristics

General conditions for all curves: Circuit of figure 1; L = 20μH (Sumida, CD54), C_{IN} = 47μF (tantalum) with 0.1μF (ceramic), C_L = 47μH (tantalum) MA735 (Matsushita) schottky diode, C_{SS} = 4700pF (ceramic), T_A = 25°C unless otherwise noted.

OUTPUT vs. AMBIENT TEMPERATURE

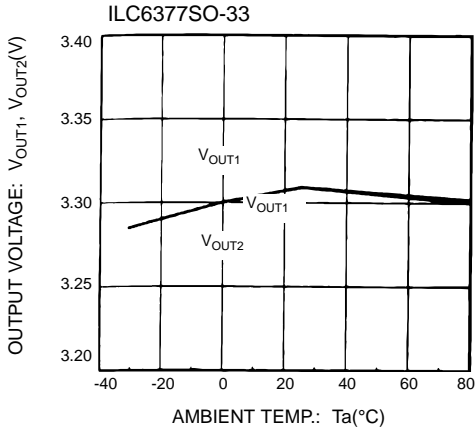

SUPPLY CURRENT vs. AMBIENT TEMPERATURE

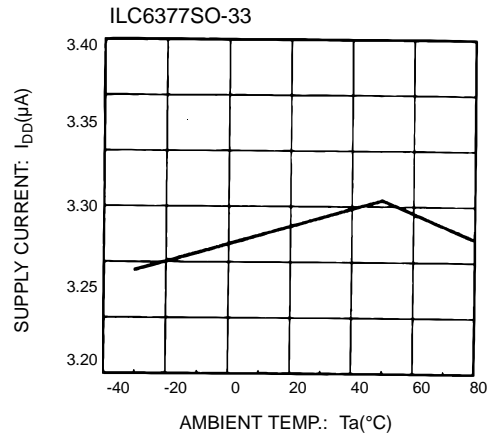

STAND-BY CURRENT vs. AMBIENT TEMPERATURE

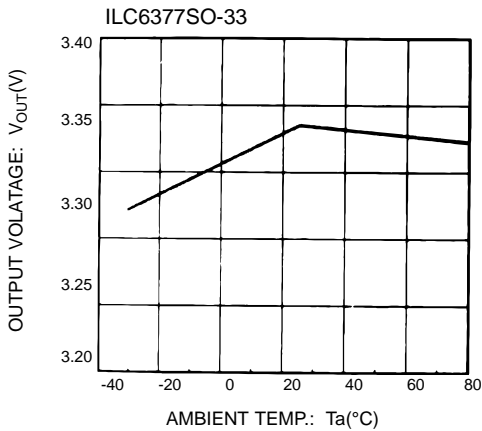

L_X ON RESISTANCE vs. AMBIENT TEMPERATURE

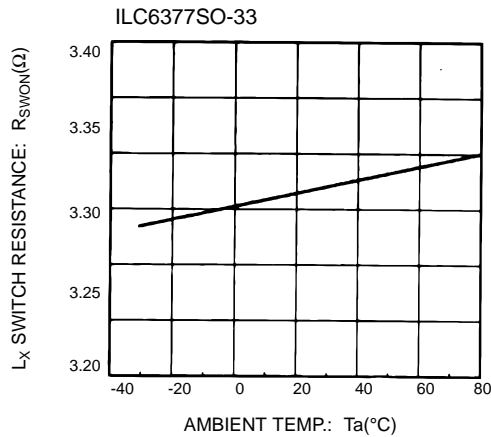

OSCILLATION FREQUENCY vs. AMBIENT TEMPERATURE

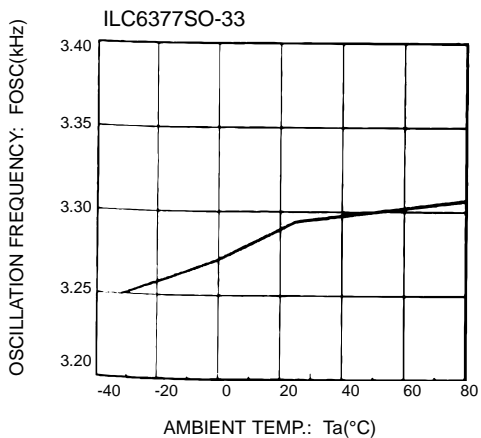

PFM DUTY RATIO vs. AMBIENT TEMPERATURE

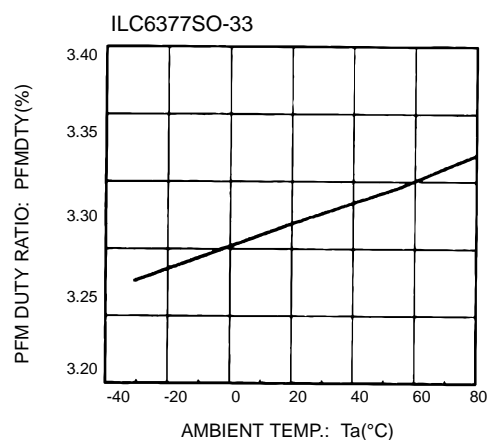

Typical Performance Characteristics

General conditions for all curves: Circuit of figure 1; L = 20μH (Sumida, CD54), C_{IN} = 47μF (tantalum) with 0.1μF (ceramic), C_L = 47μH (tantalum) MA735 (Matsushita) schottky diode, C_{SS} = 4700pF (ceramic), T_A = 25°C unless otherwise noted.

EFFICIENCY vs. AMBIENT TEMPERATURE

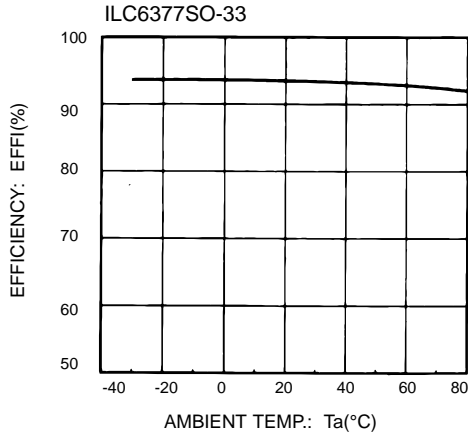

MINIMUM OPERATING VOLTAGE vs. AMBIENT TEMPERATURE

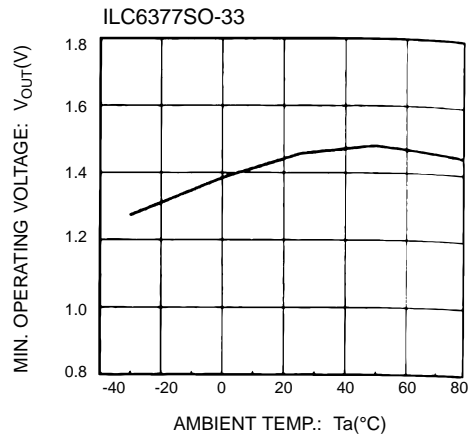

SOFT-START TIME vs. AMBIENT TEMPERATURE

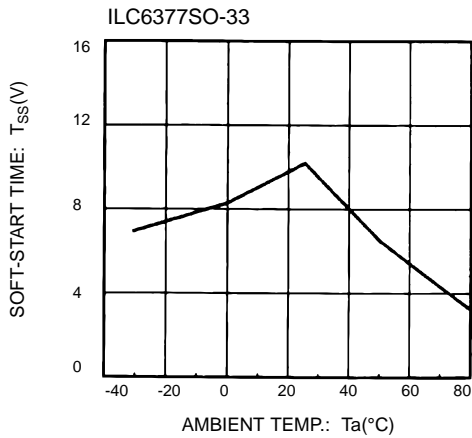

CE "L" VOLTAGE vs. AMBIENT TEMPERATURE

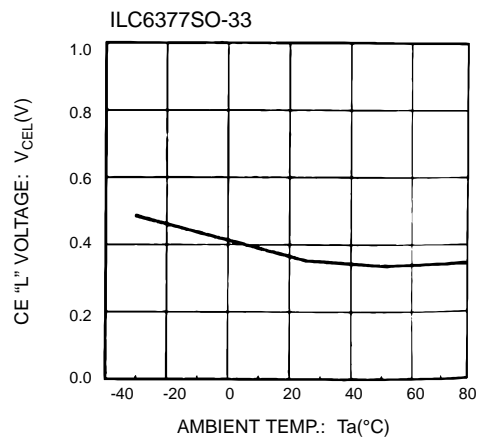

CE "H" VOLTAGE vs. AMBIENT TEMPERATURE

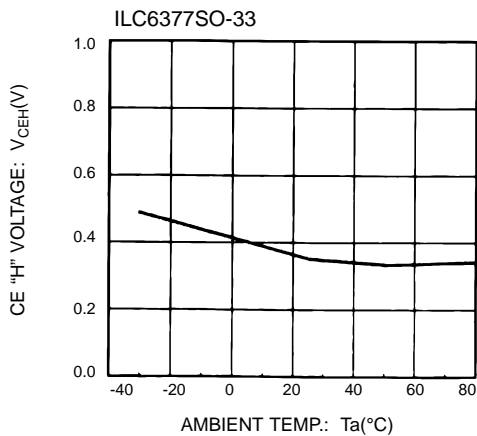

Typical Performance Characteristics

General conditions for all curves: Circuit of figure 1; L = 20μH (Sumida, CD54), C_{IN} = 47μF (tantalum) with 0.1μF (ceramic), C_L = 47μH (tantalum) MA735 (Matsushita) schottky diode, C_{SS} = 4700pF (ceramic), T_A = 25°C unless otherwise noted.

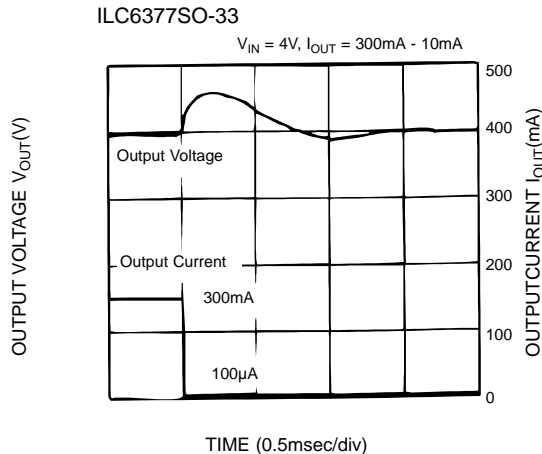
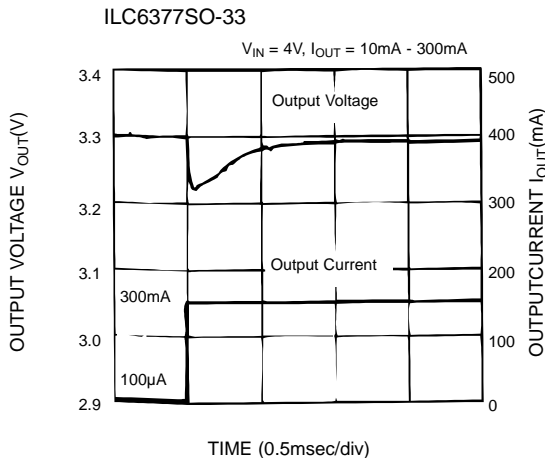
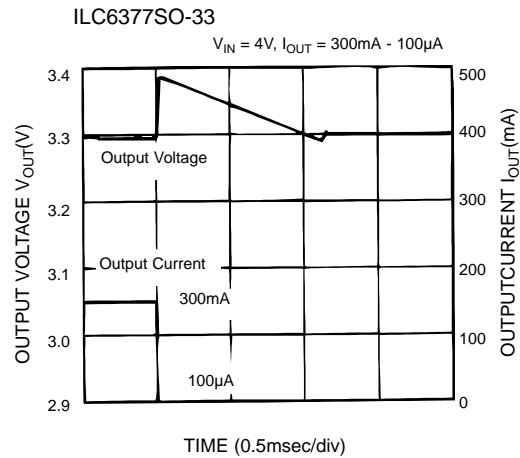
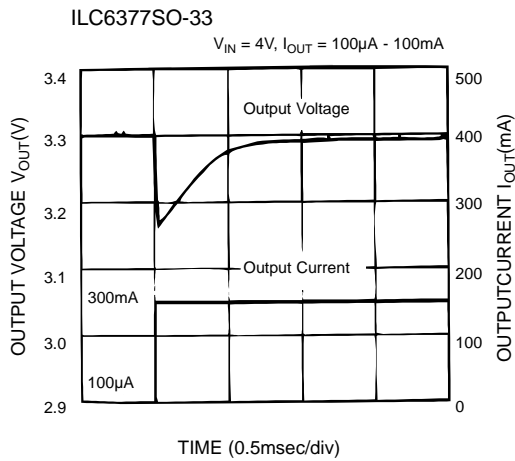
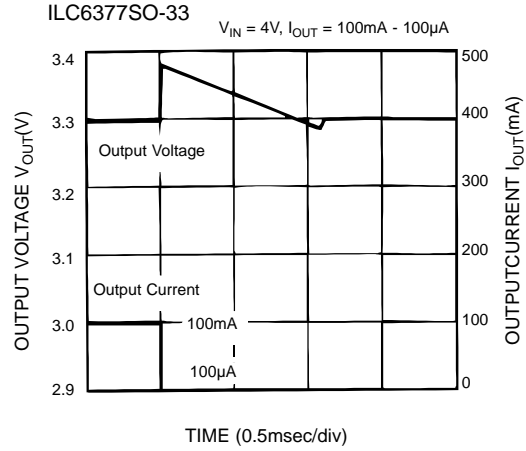
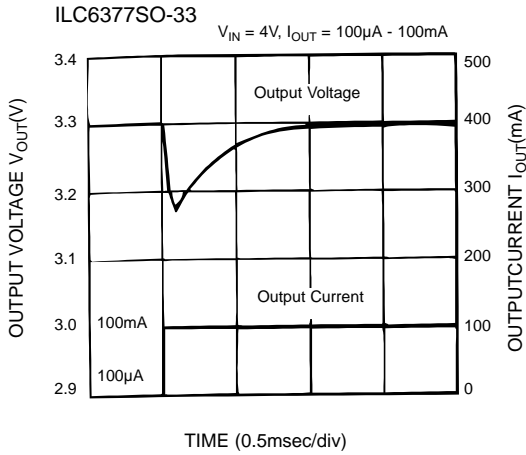

2