



LOW POWER SCHOTTKY INTEGRATED CIRCUITS

67C 16523

T-46-07-11

PRELIMINARY DATA

LS573 - OCTAL D-TYPE LATCH WITH 3-STATE OUTPUTS
LS574 - OCTAL D-TYPE FLIP-FLOP WITH 3-STATE OUTPUTS

DESCRIPTION

The T54LS/T74LS573 is an Octal D-Type Latch with 3-State Outputs designed for bus organised system applications. When Latch Enable (LE) is High the data appears transparent to the flip-flop when it is Low the data is latched. When the output Enable goes Low the data appears on the bus, when it goes HIGH the bus output is in the high impedance state. The LS573 is functionally identical to the LS373, but has different pinouts. The T54LS/T74LS574 is an octal D-Type flip-flop with 3-State Outputs designed for bus oriented applications. It is composed of a buffered clock and an output Enable common to all flip-flops. The LS574 is functionally identical to the LS374 except for the pinouts.

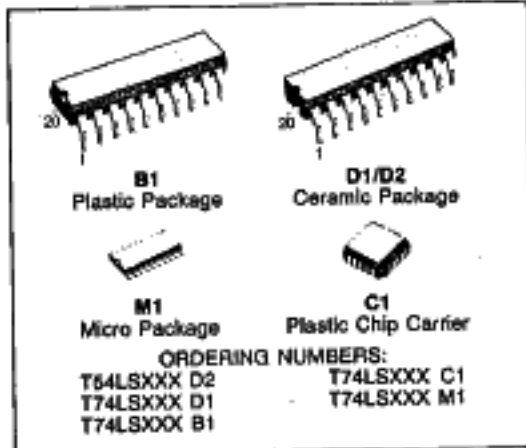

- INPUT AND OUTPUT ON OPPOSITE SIDES OF PACKAGE ALLOWING EASY INTERFACE WITH MICROPROCESSORS

PIN NAMES

D ₀ -D ₇	Data Inputs
LE	Latch Enable (Active HIGH) Input
CP	Clock (Active HIGH going edge) Input
\overline{OE}	Output Enable (Active LOW) Input
O ₀ -O ₇	Outputs

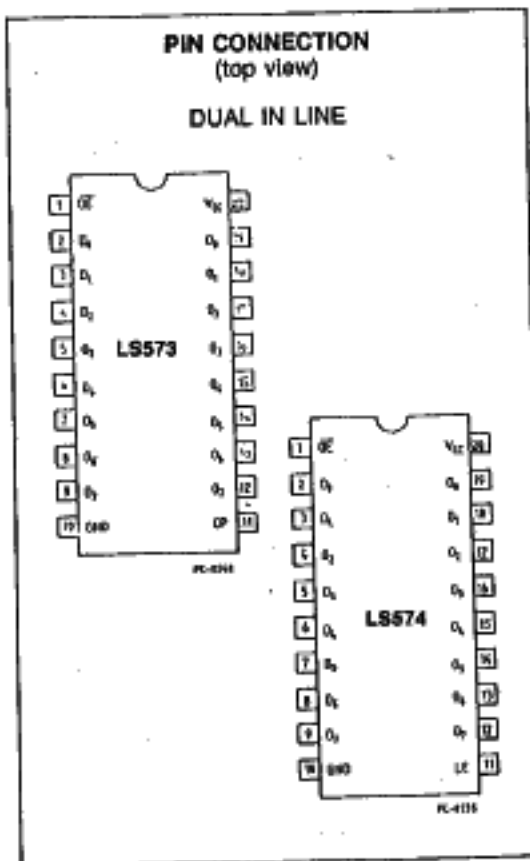



CHIP CARRIER

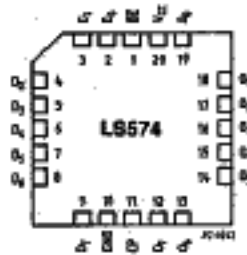
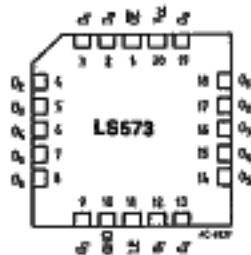

LOGIC SYMBOL

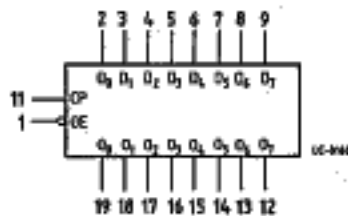
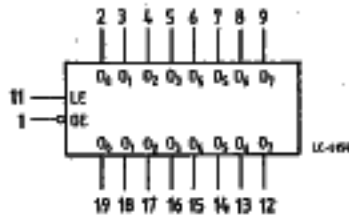

ABSOLUTE MAXIMUM RATINGS

Symbol	Parameter	Value	Unit
V _{CC}	Supply Voltage	-0.5 to 7	V
V _I	Input Voltage, Applied to Input	-0.5 to 15	V
V _O	Output Voltage, Applied to Output	-0.5 to 10	V
I _I	Input Current, Into Inputs	-30 to 5	mA
I _O	Output Current, Into Outputs	50	mA

Stresses in excess of those listed under "Absolute Maximum Ratings" may cause permanent damage to the device. This is a stress rating only and functional operation of the device at these or any other conditions in excess of those indicated in the operational sections of this specification is not implied. Exposure to absolute maximum rating conditions for extended periods may affect device reliability.



67C 16525

D

T-46-07-11

GUARANTEED OPERATING RANGES

Part Numbers	Supply Voltage			Temperature
	Min	Typ	Max	
T54LS573/574D2	4.5 V	5.0 V	5.5 V	-55°C to +125°C
T74LS573/574XX	4.75 V	5.0 V	5.25 V	0°C to +70°C

XX = package type.

DC CHARACTERISTICS OVER OPERATING TEMPERATURE RANGE

Symbol	Parameter	Limits			Test Conditions (Note 1)	Units
		Min.	Typ.	Max.		
V _{IH}	Input HIGH Voltage	2.0			Guaranteed input HIGH Voltage for all inputs	V
V _{IL}	Input LOW Voltage	54		0.7	Guaranteed input LOW Voltage for all inputs	V
		74		0.8		
V _{CD}	Input Clamp Diode Voltage		-0.65	-1.5	V _{CC} = MIN, I _{IN} = -18mA	V
V _{OH}	Output HIGH Voltage	54	2.4	3.4	V _{CC} = MIN, I _{OH} = -400µA, V _{IN} = V _{IH} or V _{IL} per Truth Table	V
		74	2.4	3.1		
V _{OL}	Output LOW Voltage	54,74	0.25	0.4	I _{OL} = 12mA V _{CC} = MIN, V _{IN} = V _{IL} or V _{IH} per Truth Table	V
		74	0.35	0.5		
I _{OZH}	Output Off Current HIGH			20	V _{CC} = MAX, V _{OUT} = 2.4V	µA
I _{OZL}	Output Off Current LOW			-20	V _{CC} = MAX, V _{OUT} = 0.4V	µA
I _{IH}	Input HIGH Current			20	V _{CC} = MAX, V _{IN} = 2.7V	µA mA
				0.1	V _{CC} = MAX, V _{IN} = 7.0V	
I _{IL}	Input LOW Current			-0.4	V _{CC} = MAX, V _{IN} = 0.4V	mA
I _{OS}	Output Short Circuit Current (Note 2)	-30		-130	V _{CC} = MAX	mA
I _{CC}	Power Supply Current			40	V _{CC} = MAX	mA

Notes:

- 1) Conditions for testing, not shown in the Table, are chosen to guarantee operation under "worst case" conditions.
- 2) Not more than one output should be shorted at a time.
- 3) Typical values are at V_{CC} = 5.0V, T_A = 25°C

14-LEAD PLASTIC DIP

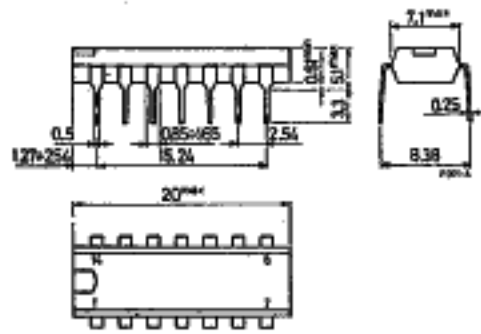
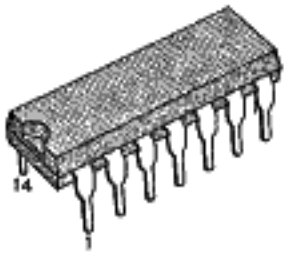

14-LEAD CERAMIC DIP

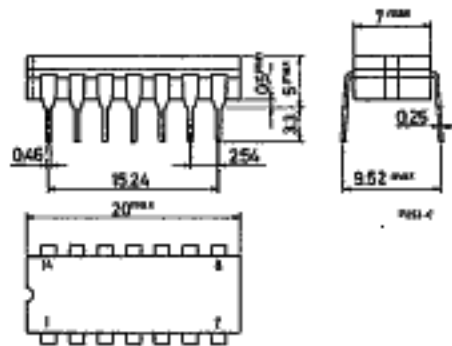
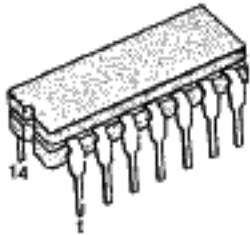

16-LEAD PLASTIC DIP

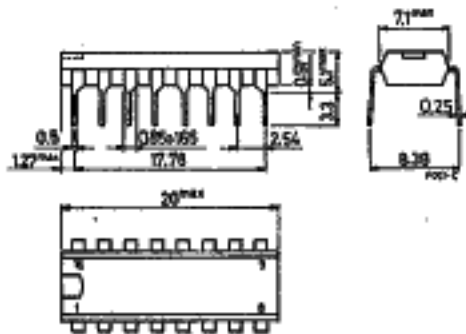
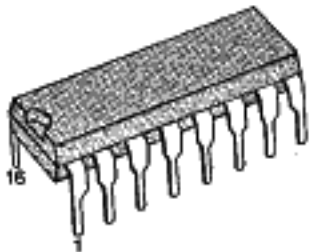

Packages

67C 16545

D

T-90-20

16-LEAD CERAMIC DIP

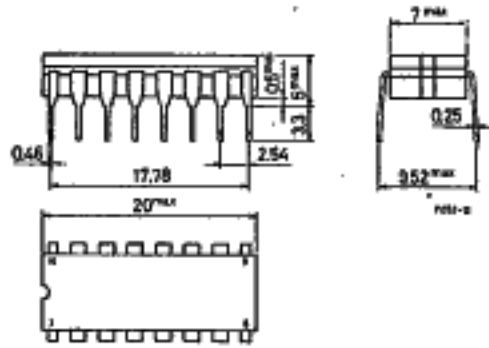
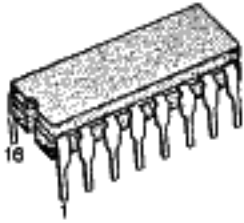

20-LEAD PLASTIC DIP

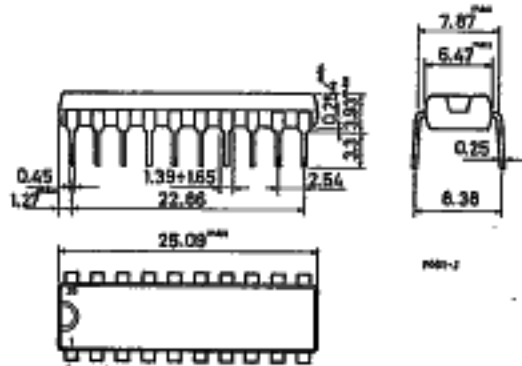
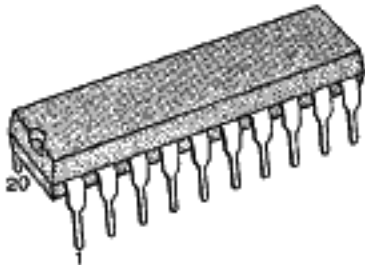

20-LEAD CERAMIC DIP

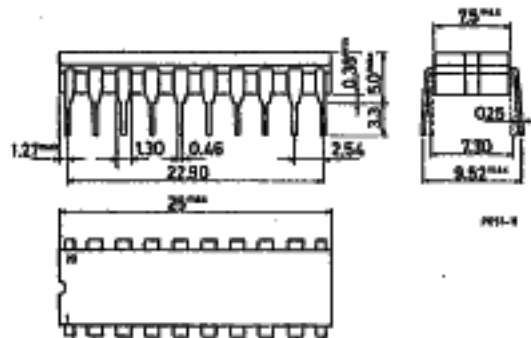
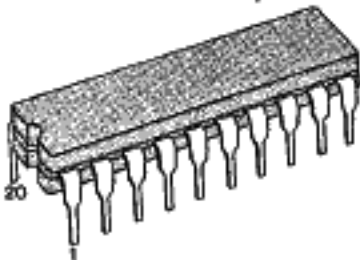

24-LEAD PLASTIC DIP

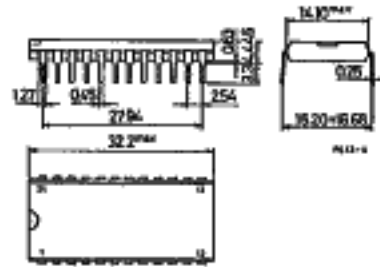
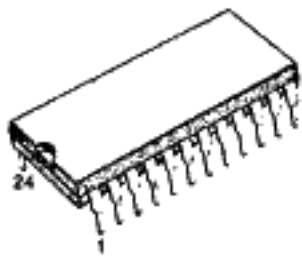

24-LEAD CERAMIC DIP

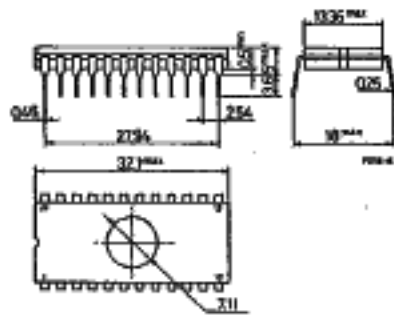
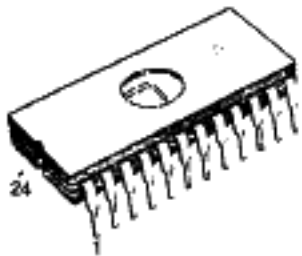

CHIP CARRIER 20 LEAD PLASTIC

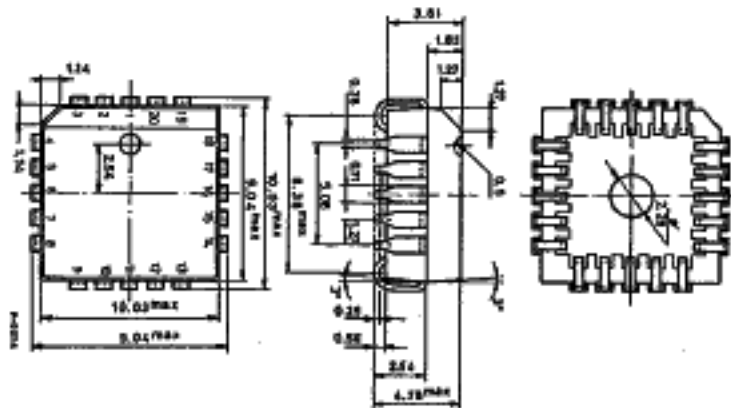

Packages

67C 15547

D

T-90-20

14-LEAD PLASTIC DIP MICROPACKAGE

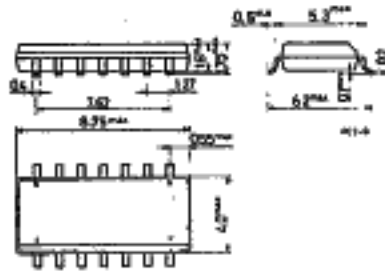
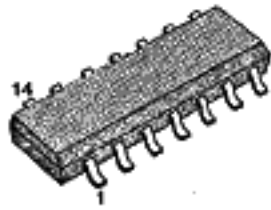

16-LEAD PLASTIC DIP MICROPACKAGE

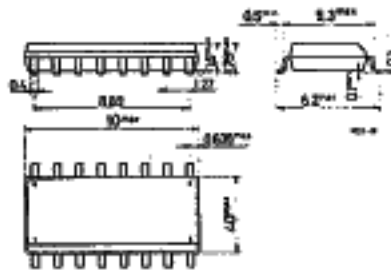
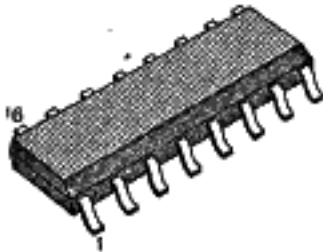

NOTE: FOR 20-LEAD PLASTIC DIP MICROPACKAGE CONTACT SGS

Surface Mounted

67C 16548 D

T-90-20

One possible solution to the important problem of PWB minimization, is that of using surface mounted components. Integrated circuits in SO (Small Outline) packages are made up of standard chips mounted in very small plastic packages. The advantages given by using these devices are:

PWB Reduction

This is by far the most important advantage since the reduction of PWB size varies from 40 to 60% in comparison with standard board types. (See page 584 for package dimensions.)

Assembly Cost Reduction

SO Devices require no preliminary operation prior to mounting and can therefore be easily utilized in fully automatic equipment.

Increasing Reliability

The following characteristics lead to a higher level of reliability with respect to their standard packaged counter parts:

- The mounting system is fully automatic
- PWB number and the interconnections between them are reduced when the same number of devices are used.
- The high density of components on the board makes it thermally much more stable.

Noise Reduction and Improved Frequency Response

The reduction of the length of the connecting wires between the leads and the silicon guarantees a more homogeneous propagation delay between the external pins, with respect to the standard type.

Assembly Without Board Holes

The devices are placed on the board and soldered. This technology permits a higher level of tolerance in the positioning (automatic) of the device. For the standard DIP types this must be done with great accuracy due to the insertion of the leads into their holes.

