

GaAs MMIC Control FET in SOT 143 DC-2.5 GHz



AF002C1-32

Features

- Low Cost
- Small SOT 143 Package
- Series or Shunt Configuration
- Low DC Current Drain
- Ideal Switch Building Block

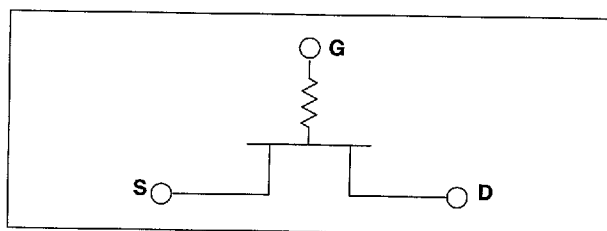
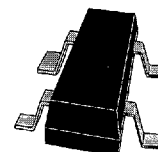

Description

The AF002C1-32 consists of a single GaAs switching FET that can be used in both series and shunt configurations. A positive control voltage may be used by simply adding 3 DC blocking capacitors.

Isolation performance degrades at higher frequencies due to package parasitics. These parasitics can be tuned out in narrow band applications as shown in a AF002C1-39 data sheet.

Absolute Maximum Ratings

| | |
|------------------------|---------------------|
| RF Input Power: | 2W > 500 MHz 0/-8V |
| | 0.5W @ 50 MHz 0/-8V |
| Control Voltage: | +0.2V, -10V |
| Operating Temperature: | -40°C to 85°C |
| Storage Temperature: | -65°C to 150°C |
| Θ _{JC} : | 25°C/W |

Note: Exceeding these parameters may cause irreversible damage.

Operating Characteristics at 25°C

| | | | |
|----------------------------------|---------------------------------|------|---------|
| Switching Characteristics | | | |
| RISE, FALL (10/90% or 90/10% RF) | 3 | ns | Typ |
| ON, OFF (50% CTL to 90/10% RF) | 6 | ns | Typ |
| Input Power for 1 dB Compression | | | |
| Control Voltages (Vdc) | 0/-5 | 0/-8 | |
| 0.5-2.0 GHz | +20 | 24 | dBm Typ |
| Control Voltages | | | |
| V ₀ (Low) | 0 to -0.2V @ 20 μA Max | | |
| V ₀ (High) | -5V @ 50 μA to -9V @ 200 μA Max | | |

Electrical Specifications at 25°C

| R _{ON} ¹ | C _{OFF} ² | Insertion Loss 1 GHz ^{3,4} | |
|------------------------------|-------------------------------|--|-------|
| | | Series | Shunt |
| 6.4 | 0.13 | 0.7 dB | 0.2 |

1. R_{ON} - Resistance in ohms in low impedance state when '0' Volts is applied on Gate (G).
2. C_{OFF} - Capacitance (FET) in pF in high impedance state when -5V is applied on Gate (G).
3. Package inductance is 3 nH, package capacitance is 0.17 pf.
4. Insertion loss changes by 0.003 dB/°C.

Typical Performance Data

Series Configuration (Not Tuned)

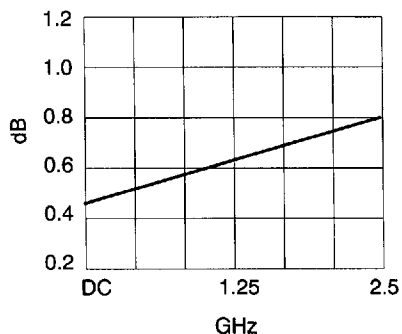

Insertion Loss vs. Frequency

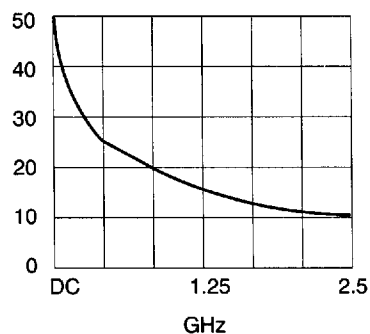

Isolation vs. Frequency

Pin Out

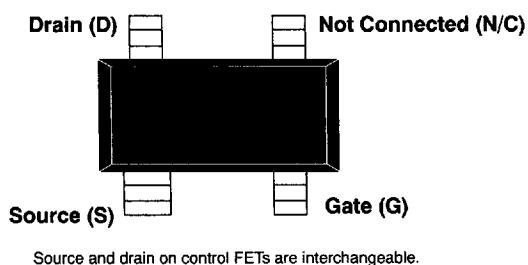

Truth Table (Negative Voltage Operation)

| Shunt | | | |
|--------|----|----|----------------|
| S | D | G | State |
| GND | RF | -5 | Insertion Loss |
| | | 0 | Isolation |
| Series | | | |
| RF | RF | -5 | Isolation |
| | | 0 | Insertion Loss |

Positive Voltage Operation

Shunt

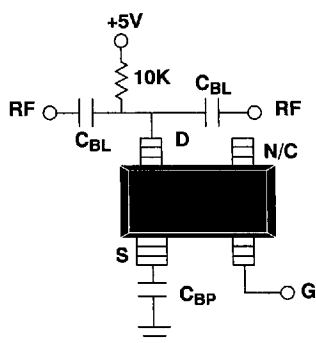

Truth Table (Positive Voltage Operation)

| Shunt | | | |
|--------|----|----|----------------|
| S | D | G | State |
| GND | RF | 0 | Insertion Loss |
| | | +5 | Isolation |
| Series | | | |
| RF | RF | 0 | Isolation |
| | | +5 | Insertion Loss |

Series

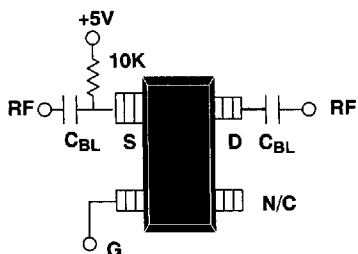

C_{BL}, C_{BP} - Choose value for low impedance at desired operating frequency.

RF GaAs MMIC Products in Metal Packages

Numerical Index

| Part Number | Page | Part Number | Page | Part Number | Page |
|-------------|------|-------------|------|-------------|------|
| AD004T2-00 | 2-44 | AK006R2-01 | 2-30 | AS006M1-01 | 2-8 |
| AD004T2-11 | 2-44 | AK006R2-10 | 2-30 | AS006M1-10 | 2-8 |
| AE002M2-29 | 2-74 | AK006R2-00 | 2-28 | AS006M2-00 | 2-16 |
| AE002M4-05 | 2-42 | AK402D4-11 | 2-64 | AS006M2-01 | 2-22 |
| AH002R2-11 | 2-26 | AK402D4-31 | 2-68 | AS006M2-10 | 2-22 |
| AK002D2-11 | 2-70 | AN002M2-29 | 2-72 | AS006R1-00 | 2-4 |
| AK002D4-11 | 2-62 | AN002M4-31 | 2-38 | AS006R2-00 | 2-16 |
| AK002D4-31 | 2-66 | AN002M4-05 | 2-40 | AS006R2-01 | 2-20 |
| AK002M4-00 | 2-36 | AS002M4-00 | 2-34 | AS006R2-10 | 2-20 |
| AK002M4-31 | 2-38 | AS004L1-08 | 2-6 | AS406M2-01 | 2-24 |
| AK004L1-11 | 2-12 | AS004L1-11 | 2-6 | AS406R2-01 | 2-24 |
| AK004M1-11 | 2-14 | AS004L2-11 | 2-18 | AT001D3-11 | 2-60 |
| AK004M2-11 | 2-32 | AS004M1-08 | 2-8 | AT001D4-31 | 2-56 |
| AK004R2-11 | 2-30 | AS004M1-11 | 2-8 | AT001D6-31 | 2-58 |
| AK006L1-00 | 2-10 | AS004M2-08 | 2-22 | AT002D8-31 | 2-54 |
| AK006L1-01 | 2-12 | AS004M2-11 | 2-22 | AT002N5-00 | 2-49 |
| AK006L1-10 | 2-12 | AS004R2-08 | 2-20 | AT002N5-01 | 2-49 |
| AK006M1-00 | 2-10 | AS004R2-11 | 2-20 | AT002N5-10 | 2-49 |
| AK006M1-01 | 2-14 | AS006L1-00 | 2-4 | AT002N5-11 | 2-49 |
| AK006M1-10 | 2-14 | AS006L1-01 | 2-6 | AT002S3-11 | 2-52 |
| AK006M2-01 | 2-32 | AS006L1-10 | 2-6 | AT004N3-11 | 2-46 |
| AK006M2-10 | 2-32 | AS006L2-00 | 2-18 | AT006N3-00 | 2-46 |
| AK006M2-00 | 2-28 | AS006L2-01 | 2-18 | AT006N3-10 | 2-46 |
| AK006R1-00 | 2-10 | AS006M1-00 | 2-4 | AT006N3-01 | 2-46 |

0585443 0002501 710