



Austin Semiconductor, Inc.

**SRAM**  
**MT5C1001**  
**Limited Availability**

## 1M x 1 SRAM

### SRAM MEMORY ARRAY

### AVAILABLE AS MILITARY SPECIFICATIONS

- SMD 5962-92316
- MIL-STD-883

### FEATURES

- High Speed: 20, 25, 35, and 45
- Battery Backup: 2V data retention
- Low power standby
- Single +5V ( $\pm 10\%$ ) Power Supply
- Easy memory expansion with CE\ and OE\ options.
- All inputs and outputs are TTL compatible
- Three-state output

### OPTIONS

#### • Timing

20ns access	-20
25ns access	-25
35ns access	-35
45ns access	-45
55ns access	-55*
70ns access	-70*

#### • Package(s)

Ceramic DIP (400 mil)	C	No. 109
Ceramic LCC	EC	No. 207
Ceramic Flatpack	F	No. 303
Ceramic SOJ	DCJ	No. 501

#### • Operating Temperature Ranges

Industrial (-40°C to +85°C)	IT
Military (-55°C to +125°C)	XT

- 2V data retention/low power L

\*Electrical characteristics identical to those provided for the 45ns access devices.

**For more products and information  
please visit our web site at  
[www.austinsemiconductor.com](http://www.austinsemiconductor.com)**

### PIN ASSIGNMENT (Top View)

28-Pin DIP (C)  
(400 MIL)

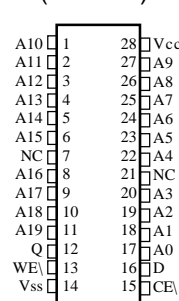

32-Pin LCC (EC)  
32-Pin SOJ (DCJ)

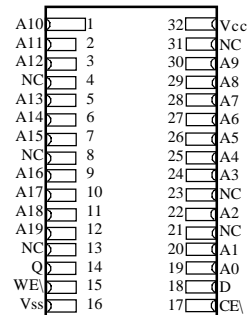

32-Pin Flat Pack (F)

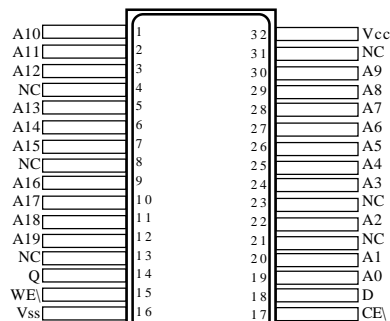

### GENERAL DESCRIPTION

The MT5C1001 employs low power, high-performance silicon-gate CMOS technology. Static design eliminates the need for external clocks or timing strobes while CMOS circuitry reduces power consumption and provides for greater reliability.

For flexibility in high-speed memory applications, ASI offers chip enable (CE\ ) and output enable (OE\ ) capability. These enhancements can place the outputs in High-Z for additional flexibility in system design. Writing to these devices is accomplished when write enable (WE\ ) and CE\ inputs are both LOW. Reading is accomplished when WE\ remains HIGH while CE\ and OE\ go LOW. The devices offer a reduced power standby mode when disabled. This allows system designs to achieve low standby power requirements.

The "L" version provides an approximate 50 percent reduction in CMOS standby current ( $I_{SBC2}$ ) over the standard version.

All devices operation from a single +5V power supply and all inputs and outputs are fully TTL compatible.



**FUNCTIONAL BLOCK DIAGRAM**

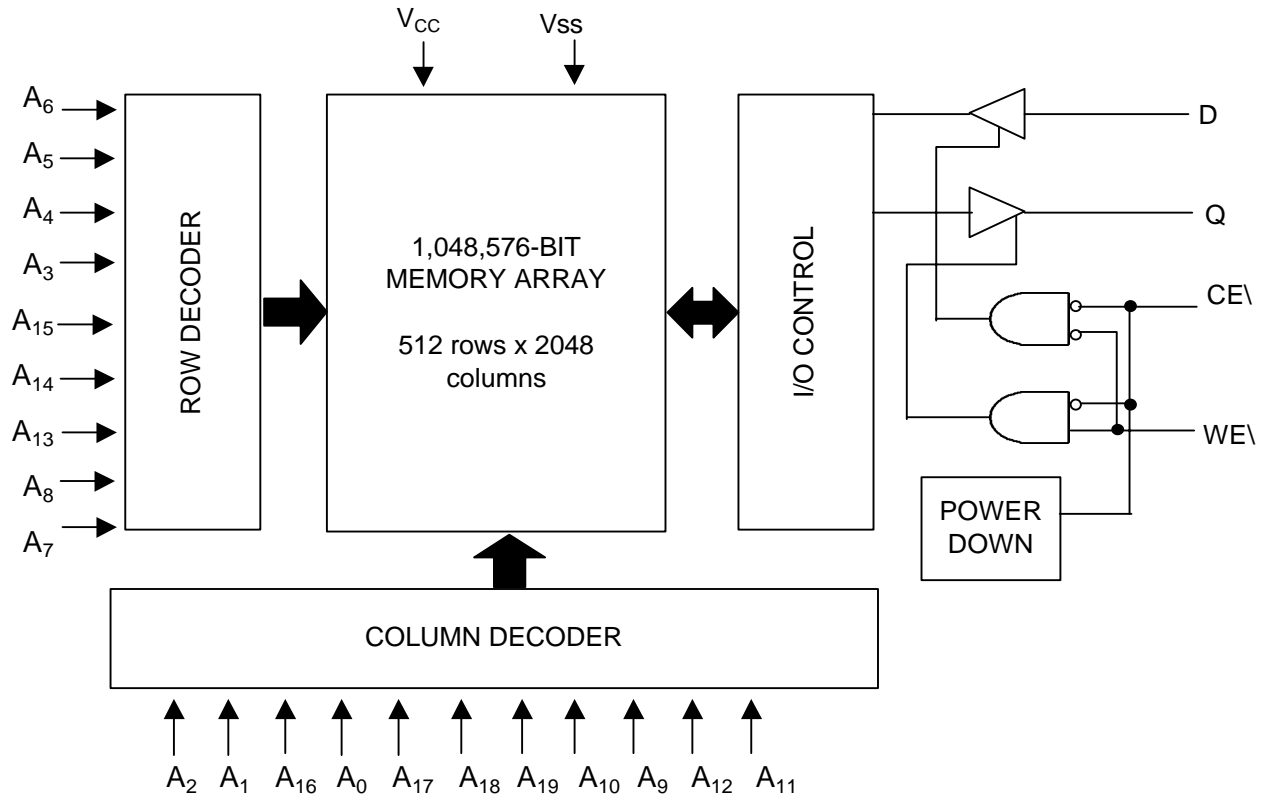

**TRUTHTABLE**

MODE	CE\	WE\	OUTPUT	POWER
STANDBY	H	X	HIGH-Z	STANDBY
READ	L	H	Q	ACTIVE
WRITE	L	L	HIGH-Z	ACTIVE

**PIN ASSIGNMENTS**

PIN	ASSIGNMENT
A <sub>0</sub> -A <sub>19</sub>	Address Inputs
WE\	Write Enable
CE\	Chip Enable
D	Data Input
Q	Data Output
NC	No Connection
V <sub>CC</sub>	+5V Power Supply
V <sub>SS</sub>	Ground



**ABSOLUTE MAXIMUM RATINGS\***

Voltage on Any Input Relative to V <sub>SS</sub> .....	-5V to +7V
Voltage on V <sub>CC</sub> Supply Relative to V <sub>SS</sub> .....	-5V to +7V
Voltage Applied to Q.....	-5V to +6V
Storage Temperature.....	-65°C to +150°C
Power Dissipation.....	1W
Short Circuit Output Current.....	20mA
Lead Temperature (soldering 10 seconds).....	+260°C
Junction Temperature.....	+175°C

\*Stresses greater than those listed under "Absolute Maximum Ratings" may cause permanent damage to the device. This is a stress rating only and functional operation of the device at these or any other conditions above those indicated in the operation section of this specification is not implied. Exposure to absolute maximum rating conditions for extended periods may affect reliability.

**ELECTRICAL CHARACTERISTICS AND RECOMMENDED DC OPERATING CONDITIONS**

(-55°C ≤ T<sub>c</sub> ≤ 125°C; V<sub>CC</sub> = 5V ±10%)

DESCRIPTION	CONDITIONS	SYMBOL	MIN	MAX	UNITS	NOTES
Input High (Logic 1) Voltage		V <sub>IH</sub>	2.2	V <sub>CC</sub> +0.5	V	1
Input Low (Logic 0) Voltage		V <sub>IL</sub>	-0.5	0.8	V	1, 2
Input Leakage Current	0V ≤ V <sub>IN</sub> ≤ V <sub>CC</sub>	I <sub>LI</sub>	-5	5	μA	
Output Leakage Current	Output(s) disabled 0V ≤ V <sub>OUT</sub> ≤ V <sub>CC</sub>	I <sub>LO</sub>	-5	5	μA	
Output High Voltage	I <sub>OH</sub> = -4.0mA	V <sub>OH</sub>	2.4		V	1
Output Low Voltage	I <sub>OL</sub> = 8.0mA	V <sub>OL</sub>		0.4	V	1

PARAMETER	CONDITIONS	SYM	MAX				UNITS	NOTES
			-20	-25	-35	-45		
Power Supply Current: Operating	CE ≤ V <sub>IL</sub> ; V <sub>CC</sub> = MAX f = MAX = 1/t <sub>RC</sub> (MIN) Output Open	I <sub>CC</sub>	125	120	115	110	mA	3
Power Supply Current: Standby	CE ≥ V <sub>IH</sub> ; V <sub>CC</sub> = MAX f = MAX = 1/t <sub>RC</sub> (MIN) Output Open	I <sub>SBT1</sub>	50	45	40	35	mA	
	CE ≥ V <sub>IH</sub> ; All Other Inputs ≤ V <sub>IH</sub> or ≥ V <sub>IH</sub> ; V <sub>CC</sub> = MAX f = 0 Hz	I <sub>SBT2</sub>	25	25	25	25	mA	
	CE ≤ V <sub>CC</sub> - 0.2V; V <sub>CC</sub> = MAX V <sub>IL</sub> ≤ V <sub>SS</sub> + 0.2V V <sub>IH</sub> ≥ V <sub>CC</sub> - 0.2V; f = 0 Hz	I <sub>SBC2</sub>	10	10	10	10	mA	
	"L" Version Only	I <sub>SBC2</sub>	5	5	5	5	mA	

**CAPACITANCE**

PARAMETER	CONDITIONS	SYMBOL	MAXIMUM	UNITS	NOTES
Input Capacitance (A3-A5, A15 -A17)	T <sub>A</sub> = 25°C, f = 1MHz V <sub>CC</sub> = 5V	C <sub>I</sub>	10	pF	4
Output Capacitance (Q)		C <sub>O</sub>	8	pF	4
Input Capacitance: (All Other Inputs)		C <sub>I</sub>	8	pF	4



**ELECTRICAL CHARACTERISTICS AND RECOMMENDED AC OPERATING CONDITIONS**

(Note 5) ( $-55^{\circ}\text{C} \leq T_c \leq 125^{\circ}\text{C}$ ;  $V_{cc} = 5\text{V} \pm 10\%$ )

DESCRIPTION	SYMBOL	-20		-25		-35		-45		UNITS	NOTES
		MIN	MAX	MIN	MAX	MIN	MAX	MIN	MAX		
<b>READ CYCLE</b>											
READ cycle time	$t_{RC}$	20		25		35		45		ns	
Address access time	$t_{AA}$		20		25		35		45	ns	
Chip Enable access time	$t_{ACE}$		20		25		35		45	ns	
Output hold from address change	$t_{OH}$	3		3		3		3		ns	
Chip Enable to output in Low-Z	$t_{LZCE}$	3		3		3		3		ns	4, 6, 7
Chip disable to output in High-Z	$t_{HZCE}$		8		10		15		15	ns	4, 6, 7
Chip Enable to power-up time	$t_{PU}$	0		0		0		0		ns	4
Chip disable to power-down time	$t_{PD}$		20		25		35		45	ns	4
<b>WRITE CYCLE</b>											
WRITE cycle time	$t_{WC}$	20		25		35		45		ns	
Chip Enable to end of write	$t_{CW}$	15		16		20		25		ns	
Address valid to end of write	$t_{AW}$	15		16		20		25		ns	
Address setup time	$t_{AS}$	0		0		0		0		ns	
Address hold from end of write	$t_{AH}$	1		1		1		1		ns	
WRITE pulse width	$t_{WP}$	15		16		20		25		ns	
Data setup time	$t_{DS}$	8		10		13		15		ns	
Data hold time	$t_{DH}$	0		0		0		0		ns	
Write disable to output in Low-Z	$t_{LZWE}$	3		3		3		3		ns	7
Write Enable to output in High-Z	$t_{HZWE}$	0	9	0	10	0	13	0	13	ns	4, 6, 7



**ACTEST CONDITIONS**

Input pulse levels .....	V <sub>ss</sub> to 3.0V
Input rise and fall times .....	5ns
Input timing reference levels .....	1.5V
Output reference levels .....	1.5V
Output load .....	See Figures 1 and 2

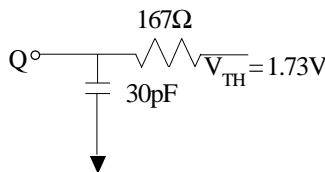

Fig. 1 Output Load Equivalent

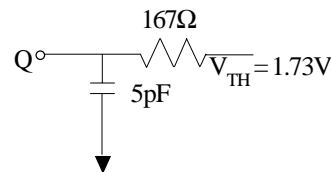

Fig. 2 Output Load Equivalent

**NOTES**

- All voltages referenced to V<sub>ss</sub> (GND).
- 3V for pulse width < 20ns
- I<sub>CC</sub> is dependent on output loading and cycle rates. The specified value applies with the outputs unloaded, and  $f = \frac{1}{t_{RC}(\text{MIN})}$  Hz.
- This parameter is guaranteed but not tested.
- Test conditions as specified with the output loading as shown in Fig. 1 unless otherwise noted.
- t<sub>LZCE</sub>, t<sub>LZWE</sub>, t<sub>LZOE</sub>, t<sub>HZCE</sub>, t<sub>HZOE</sub> and t<sub>HZWE</sub> are specified with CL = 5pF as in Fig. 2. Transition is measured ±200mV typical from steady state voltage, allowing for actual tester RC time constant.
- At any given temperature and voltage condition, t<sub>HZCE</sub> is less than t<sub>LZCE</sub>, and t<sub>HZWE</sub> is less than t<sub>LZWE</sub> and t<sub>HZOE</sub> is less than t<sub>LZOE</sub>.
- WE\ is HIGH for READ cycle.
- Device is continuously selected. Chip enables and output enables are held in their active state.
- Address valid prior to, or coincident with, latest occurring chip enable.
- t<sub>RC</sub> = Read Cycle Time.
- Chip enable (CE\ ) and write enable (WE\ ) can initiate and terminate a WRITE cycle.

**DATA RETENTION ELECTRICAL CHARACTERISTICS (L Version Only)**

DESCRIPTION	CONDITIONS	SYMBOL	MIN	MAX	UNITS	NOTES
V <sub>CC</sub> for Retention Data		V <sub>DR</sub>	2	--	V	
Data Retention Current	CE\ ≥ (V <sub>CC</sub> - 0.2V) and V <sub>IN</sub> > (V <sub>CC</sub> - 0.2V) or ≤ 0.2V	V <sub>CC</sub> = 2V		1.0	mA	
		V <sub>CC</sub> = 3V		1.5	mA	
Chip Deselect to Data Retention Time		t <sub>CDR</sub>	0	--	ns	4
Operation Recovery Time		t <sub>R</sub>	t <sub>RC</sub>		ns	4, 11

**LOW V<sub>CC</sub> DATA RETENTION WAVEFORM**

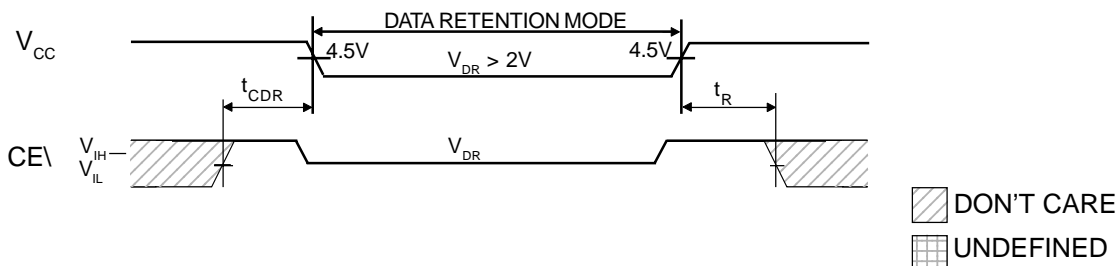



**READ CYCLE NO. 1** <sup>8,9</sup>

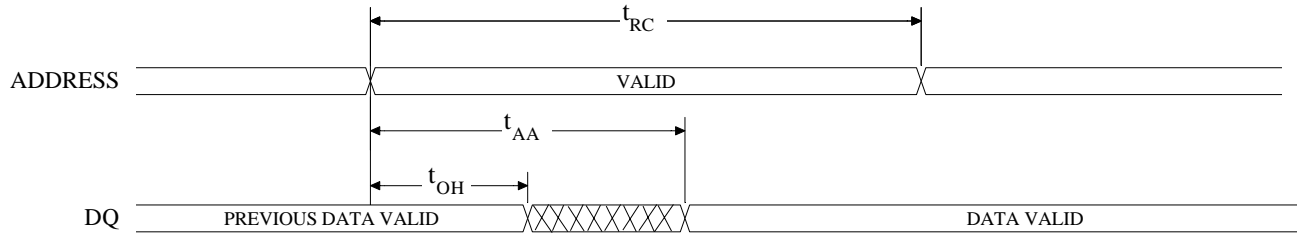

**READ CYCLE NO. 2** <sup>7, 8, 10</sup>

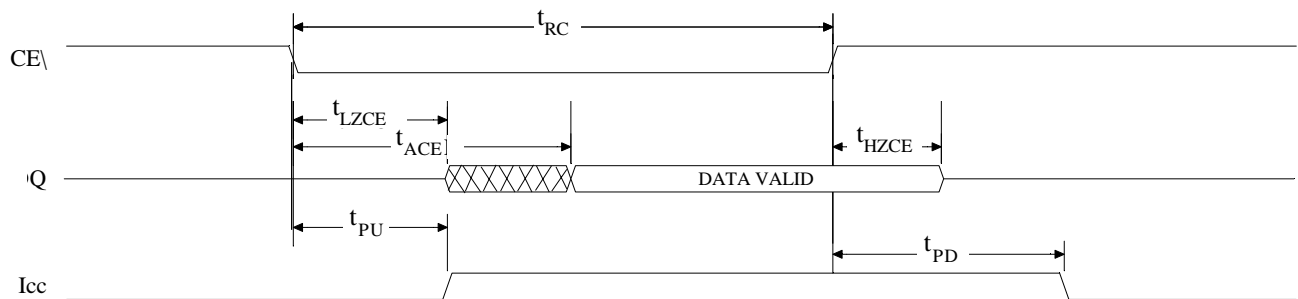



**WRITE CYCLE NO. 1 <sup>12</sup>**  
**(Chip Enabled Controlled)**

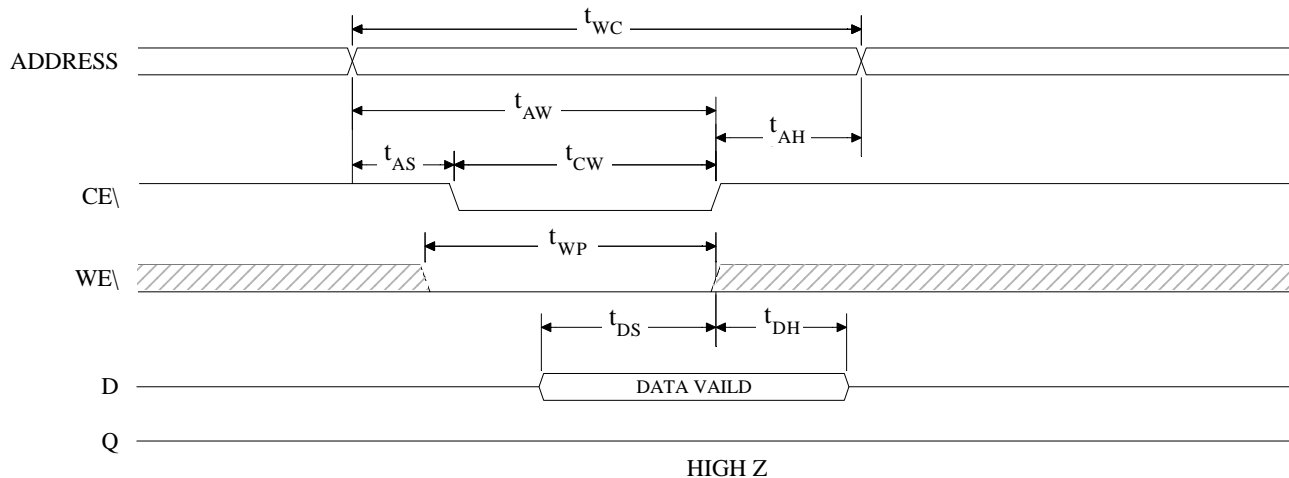

**WRITE CYCLE NO. 2 <sup>7,12</sup>**  
**(Write Enabled Controlled)**

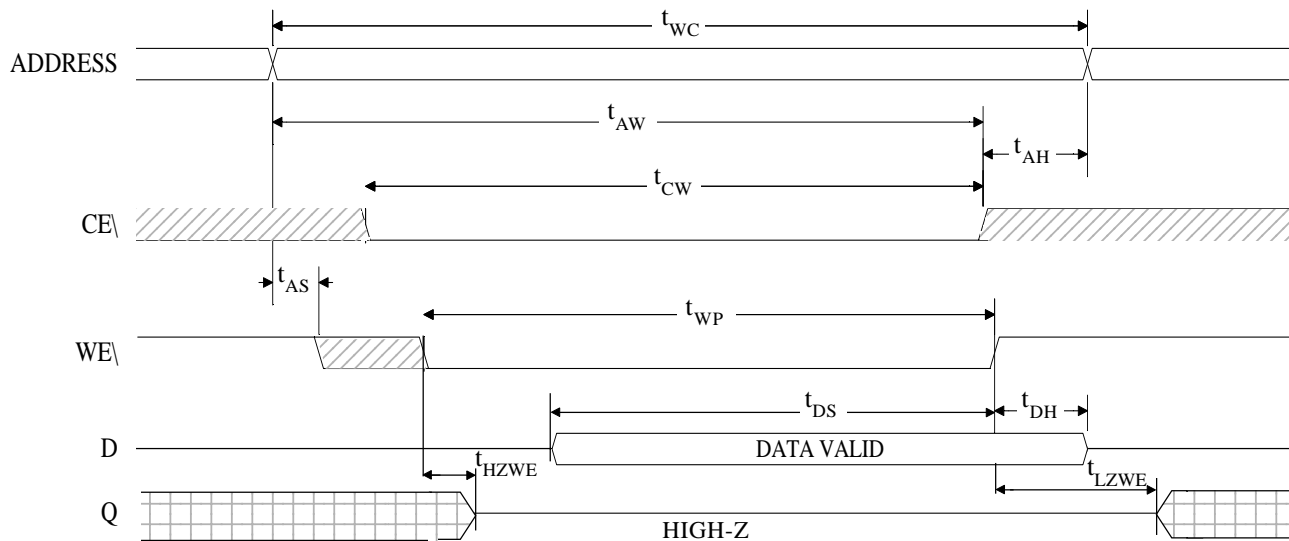

**NOTE:** Output enable (OE\) is inactive (HIGH).

▨ DON'T CARE  
▣ UNDEFINED



**MECHANICAL DEFINITIONS\***

**ASI Case #109 (Package Designator C)  
SMD #5962-92316, Case Outline T**

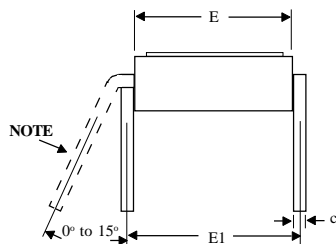
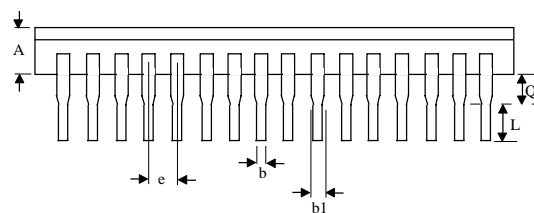
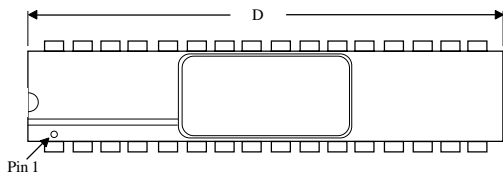

SYMBOL	SMD SPECIFICATIONS	
	MIN	MAX
A	0.075	0.095
b	0.016	0.020
b1	0.040	0.060
c	0.008	0.012
D	1.386	1.414
E	0.385	0.405
E1	0.390	0.410
e	0.100 BSC	
L	0.125	0.175
Q	0.040	0.060

**NOTE:** These dimensions are per the SMD. ASI's package dimensional limits may differ, but they will be within the SMD limits.

\*All measurements are in inches.





### MECHANICAL DEFINITIONS\*

### ASI Case #207 (Package Designator EC) SMD# 5962-92316, Case Outline Y

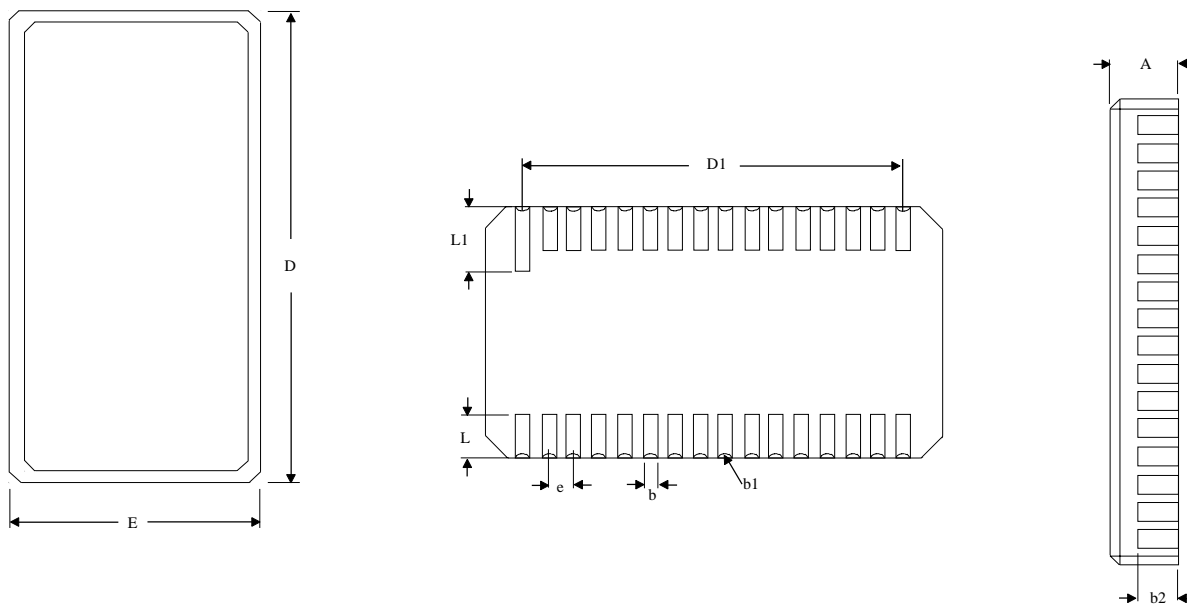

SYMBOL	SMD SPECIFICATIONS	
	MIN	MAX
A	0.080	0.100
b	0.022	0.028
b1	0.004	0.014
b2	0.054	0.066
D	0.815	0.835
D1	0.740	0.760
E	0.392	0.408
e	0.050 BSC	
L	0.070	0.080
L1	0.090	0.110

**NOTE:** These dimensions are per the SMD. ASI's package dimensional limits may differ, but they will be within the SMD limits.

\*All measurements are in inches.



**MECHANICAL DEFINITIONS\***

**ASI Case #303 (Package Designator F)**  
**SMD #5962-92316, Case Outline Z**

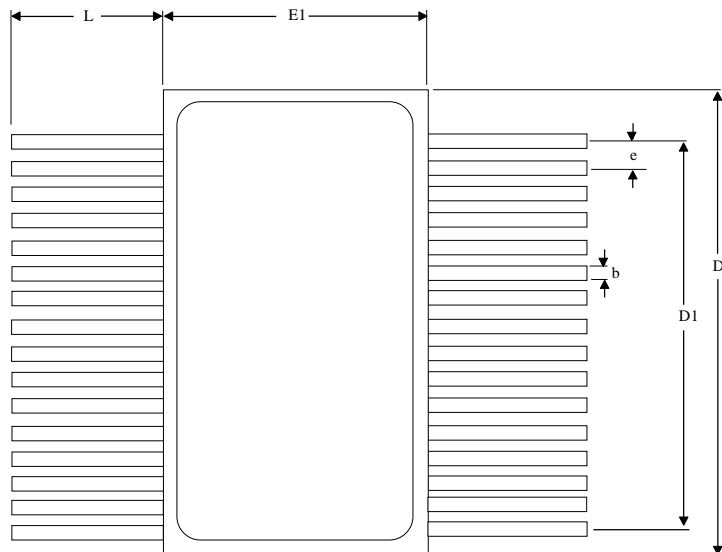

**Top View**

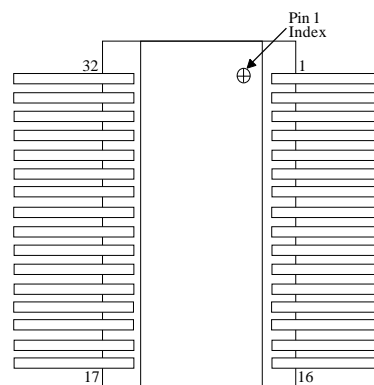

**Bottom View**

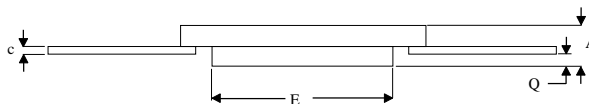

SYMBOL	SMD SPECIFICATIONS	
	MIN	MAX
A	0.097	0.117
b	0.015	0.019
c	0.004	0.006
D	0.812	0.828
D1	0.745	0.755
E	0.324	0.336
E1	0.405	0.415
e	0.050 BSC	
L	0.290	0.310
Q	0.032	0.038

**NOTE:** These dimensions are per the SMD. ASI's package dimensional limits may differ, but they will be within the SMD limits.

\*All measurements are in inches.



**MECHANICAL DEFINITIONS\***

**ASI Case #501 (Package Designator DCJ)**  
**SMD #5962-92316, Case Outline U**

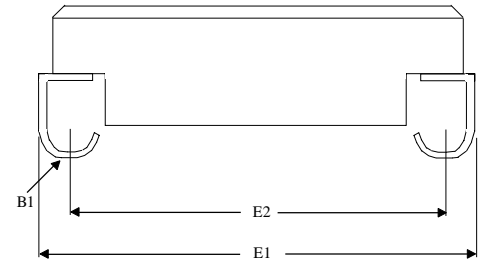
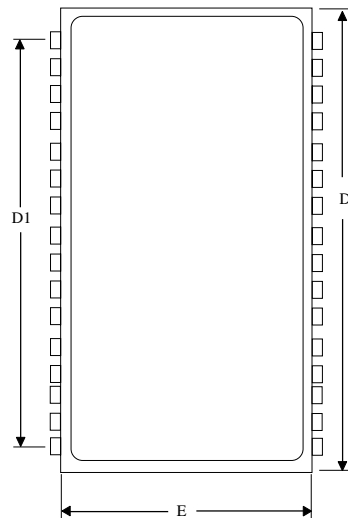
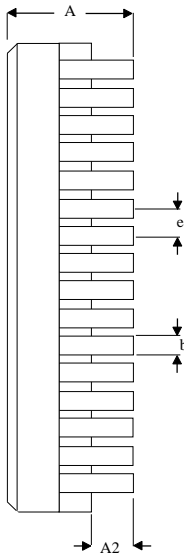

SYMBOL	SMD SPECIFICATIONS	
	MIN	MAX
A	0.135	0.153
A2	0.026	0.036
B1	0.030	0.040
b	0.015	0.019
D	0.812	0.828
D1	0.745	0.760
E	0.405	0.415
E1	0.435	0.445
E2	0.360	0.380
e	0.050 BSC	

**NOTE:** *These dimensions are per the SMD. ASI's package dimensional limits may differ, but they will be within the SMD limits.*

\*All measurements are in inches.



## ORDERING INFORMATION

EXAMPLE: MT5C1001C-20L/IT

Device Number	Package Type	Speed ns	Options**	Process
MT5C1001	C	-20	L	/*
MT5C1001	C	-25	L	/*
MT5C1001	C	-35	L	/*
MT5C1001	C	-40	L	/*
MT5C1001	C	-55	L	/*
MT5C1001	C	-70	L	/*

EXAMPLE: MT5C1001EC-45/XT

Device Number	Package Type	Speed ns	Options**	Process
MT5C1001	EC	-20	L	/*
MT5C1001	EC	-25	L	/*
MT5C1001	EC	-35	L	/*
MT5C1001	EC	-40	L	/*
MT5C1001	EC	-55	L	/*
MT5C1001	EC	-70	L	/*

EXAMPLE: MT5C1001F-25L/883C

Device Number	Package Type	Speed ns	Options**	Process
MT5C1001	F	-20	L	/*
MT5C1001	F	-25	L	/*
MT5C1001	F	-35	L	/*
MT5C1001	F	-40	L	/*
MT5C1001	F	-55	L	/*
MT5C1001	F	-70	L	/*

EXAMPLE: MT5C1001DCJ-70/XT

Device Number	Package Type	Speed ns	Options**	Process
MT5C1001	DCJ	-20	L	/*
MT5C1001	DCJ	-25	L	/*
MT5C1001	DCJ	-35	L	/*
MT5C1001	DCJ	-40	L	/*
MT5C1001	DCJ	-55	L	/*
MT5C1001	DCJ	-70	L	/*

### \*AVAILABLE PROCESSES

IT = Industrial Temperature Range  
XT = Extended Temperature Range  
883C = Full Military Processing

-40°C to +85°C  
-55°C to +125°C  
-55°C to +125°C

### \*\* OPTIONS

L = 2V Data Retention/Low Power



**ASITO DSCC PART NUMBER  
CROSS REFERENCE\***

**ASI Package Designator C**

**ASI Package Designator EC**

<b>ASI Part #</b>	<b>SMD Part #</b>
MT5C1001C-20L/883C	5962-9231608MTA
MT5C1001C-20/883C	5962-9231604MTA
MT5C1001C-25L/883C	5962-9231607MTA
MT5C1001C-25/883C	5962-9231603MTA
MT5C1001C-35L/883C	5962-9231606MTA
MT5C1001C-35/883C	5962-9231602MTA
MT5C1001C-45L/883C	5962-9231605MTA
MT5C1001C-45/883C	5962-9231601MTA

<b>ASI Part #</b>	<b>SMD Part #</b>
MT5C1001EC-20L/883C	5962-9231608MYA
MT5C1001EC-20/883C	5962-9231604MYA
MT5C1001EC-25L/883C	5962-9231607MYA
MT5C1001EC-25/883C	5962-9231603MYA
MT5C1001EC-35L/883C	5962-9231606MYA
MT5C1001EC-35/883C	5962-9231602MYA
MT5C1001EC-45L/883C	5962-9231605MYA
MT5C1001EC-45/883C	5962-9231601MYA

**ASI Package Designator F**

**ASI Package Designator DCJ**

<b>ASI Part #</b>	<b>SMD Part #</b>
MT5C1001F-20L/883C	5962-9231608MZA
MT5C1001F-20/883C	5962-9231604MZA
MT5C1001F-25L/883C	5962-9231607MZA
MT5C1001F-25/883C	5962-9231603MZA
MT5C1001F-35L/883C	5962-9231606MZA
MT5C1001F-35/883C	5962-9231602MZA
MT5C1001F-45L/883C	5962-9231605MZA
MT5C1001F-45/883C	5962-9231601MZA

<b>ASI Part #</b>	<b>SMD Part #</b>
MT5C1001DCJ-20L/883C	5962-9231608MUA
MT5C1001DCJ-20/883C	5962-9231604MUA
MT5C1001DCJ-25L/883C	5962-9231607MUA
MT5C1001DCJ-25/883C	5962-9231603MUA
MT5C1001DCJ-35L/883C	5962-9231606MUA
MT5C1001DCJ-35/883C	5962-9231602MUA
MT5C1001DCJ-45L/883C	5962-9231605MUA
MT5C1001DCJ-45/883C	5962-9231601MUA

\* ASI part number is for reference only. Orders received referencing the SMD part number will be processed per the SMD.