

NJG1712KC1

■ABSOLUTE MAXIMUM RATINGS

($T_a=+25^{\circ}\text{C}$, $Z_s=Z_i=50\Omega$)

PARAMETER	SYMBOL	CONDITIONS	RATINGS	UNITS
LNA Voltage	V_{LNA}		6.0	V
Gain Control Voltage	V_{CONT}		4.0	V
Mixer Voltage	V_{MIX}		6.0	V
LOCAL Amplifier Voltage	V_{LO}		6.0	V
Input Power 1	P_{LNAIN}	$V_{LNA}=2.85\text{V}$	+20	dBm
Input Power 2	P_{MIXIN}	$V_{MIX}=V_{LO}=2.8\text{V}$	+10	dBm
Input Power 3	P_{LOIN}	$V_{MIX}=V_{LO}=2.8\text{V}$	+10	dBm
Power Dissipation	P_D		550	mW
Operating Temperature	T_{opr}		-40~+85	$^{\circ}\text{C}$
Storage Temperature	T_{stg}		-55~+125	$^{\circ}\text{C}$

■ELECTRICAL CHARACTERISTICS 1 (LNA)

GENERAL CONDITIONS: $T_a=+25^{\circ}\text{C}$, $V_{LNA}=2.8\text{V}$, $V_{MIX}=V_{LO}=0\text{V}$, $f_{RF}=850\text{MHz}$
 $P_{RF}=-30\text{dBm}$, $Z_s=Z_i=50\Omega$, with the test circuit

PARAMETER	SYMBOL	CONDITIONS	MIN	TYP	MAX	UNITS
Operating Frequency	Freq		830	850	870	MHz
LNA Voltage	V_{LNA}		2.7	2.8	4.5	V
Gain Control Range	V_{CONT}		0.0	1.9	3.0	V
LNA Operating Current	I_{LNA}	P_{RF} OFF	-	6.3	7.5	mA
Small Signal Gain	Gain	$V_{CONT}=1.9\text{V}$	14.0	15.0	16.0	dB
Gain Flatness	G_{flat}	$f_{RF}=869\sim 894\text{MHz}$	-	0.5	1.0	dB
Dynamic Range	G_{CONT}	$V_{CONT}=0.1$ to 1.9V	21	24	-	dB
Noise Figure	NF_{LNA}	$V_{CONT}=1.9\text{V}$	-	1.3	1.6	dB
Pout at 1dB Gain Compression point	P_{-1dB}		+3.0	5.5	-	dBm
Input 3rd Order Intercept point	IIP3	$V_{CONT}=1.9\text{V}$ ^{*1} $V_{CONT}=0.1\text{V}$ ^{*1}	+2.0 +21.0	+4.0 +26.0	-	dBm dBm
RF IN VSWR	$VSWR_i$		-	2.0	2.5	
RF OUT VSWR	$VSWR_o$		-	1.5	2.0	

^{*1} Two tones of -30dBm each, $f=850.0+850.1\text{MHz}$

■ ELECTRICAL CHARACTERISTICS 2 (Mixer)

GENERAL CONDITIONS: $T_a=+25^{\circ}\text{C}$, $V_{\text{MIX}}=V_{\text{LO}}=2.8\text{V}$, $f_{\text{RF}}=850\text{MHz}$, $f_{\text{LO}}=740\text{MHz}$
 $P_{\text{RF}}=-30\text{dBm}$, $P_{\text{LO}}=-10\text{dBm}$, $Z_s=Z_l=50\Omega$, with the test circuit

PARAMETER	SYMBOL	CONDITIONS	MIN	TYP	MAX	UNITS
Operating Frequency	Freq		830	850	870	MHz
Mixer Voltage	V_{MIX}		2.7	2.8	4.5	V
Local Amplifier Voltage	V_{LO}		2.7	2.8	4.5	V
Mixer Current	I_{MIX}	$P_{\text{RF}}, P_{\text{LO}}=\text{OFF}$	-	7.5	9.1	mA
Local Current	I_{LO}	$P_{\text{RF}}, P_{\text{LO}}=\text{OFF}$		1.2	1.5	mA
Conversion Gain	G_c		8.5	10.0	-	dB
Noise Figure	NF_{MIX}		-	6.5	7.5	dB
Pout at 1dB Gain Compression point	$P_{-1\text{dB}}$		+0	+3.0	-	dBm
Input 3rd Order Intercept Point	IIP3	Two tone of -30dBm each $f_{\text{RF}}=881.0+881.1\text{MHz}$	+4.0	+6.0	-	dBm
Lo to RF Isolation	ISL1		5	10	-	dB
Lo to IF Isolation	ISL2		25	30		dB
MIXER IN VSWR	VSWR_{MIX}		-	1.5	2.0	
LOCAL IN VSWR	VSWR_{LO}		-	1.5	2.0	
IF OUT VSWR	VSWR_{IF}		-	1.5	2.0	

NJG1712KC1

■ TYPICAL CHARACTERISTICS (LNA, with test circuit)

Gain, NF vs. Frequency

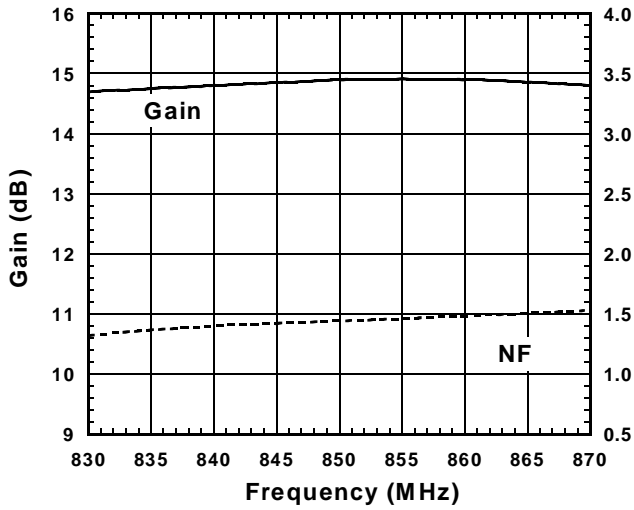

Condition
 $f=830\sim 870\text{MHz}$
 $V_{LNA}=2.8\text{V}, V_{CONT}=1.9\text{V}$
 $V_{MIX}=V_{LO}=0\text{V}$

Gain, NF vs. Frequency

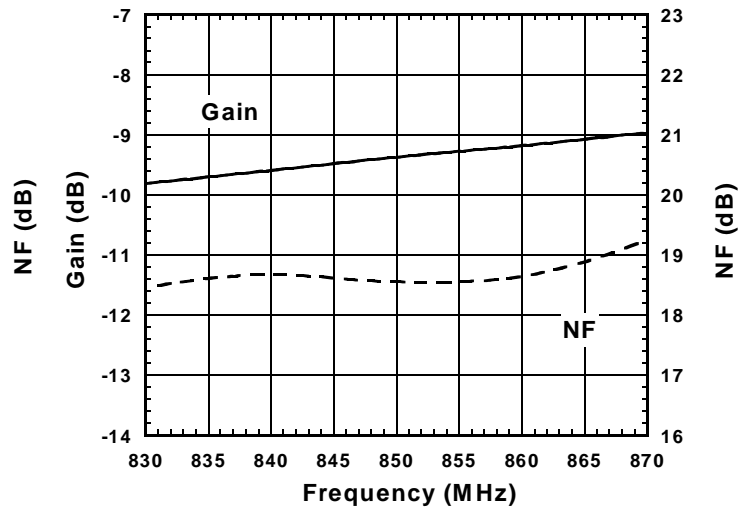

Condition
 $f=830\sim 870\text{MHz}$
 $V_{LNA}=2.8\text{V}, V_{CONT}=0.1\text{V}$
 $V_{MIX}=V_{LO}=0\text{V}$

Output Power vs. Input Power

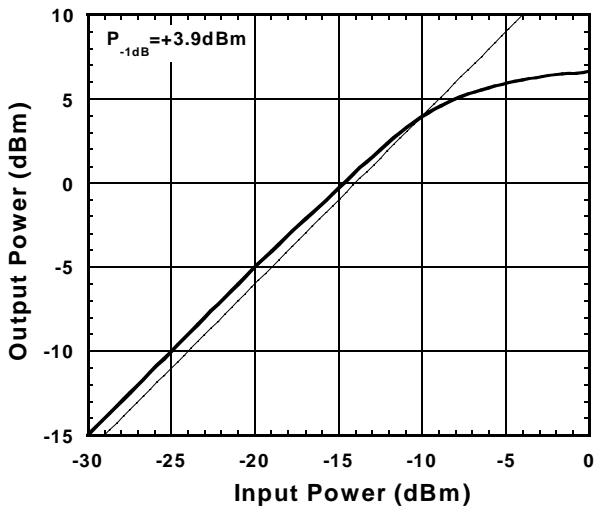

Condition
 $f=850\text{MHz}$
 $V_{LNA}=2.8\text{V}, V_{CONT}=1.9\text{V}$
 $V_{MIX}=V_{LO}=0\text{V}$

Output Power vs. Input Power

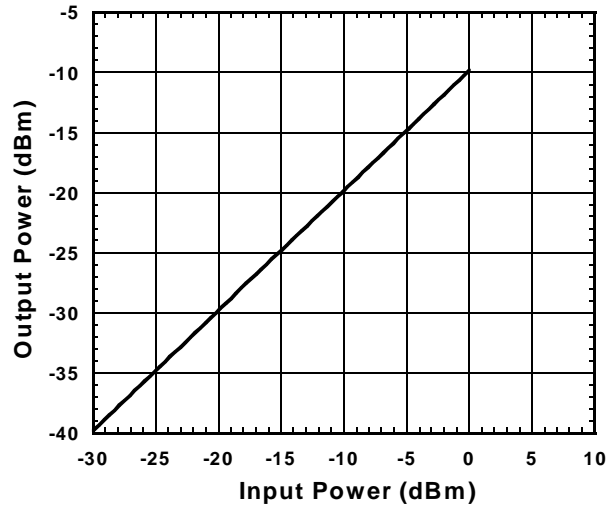

Condition
 $f=850\text{MHz}$
 $V_{LNA}=2.8\text{V}, V_{CONT}=0.1\text{V}$
 $V_{MIX}=V_{LO}=0\text{V}$

■ TYPICAL CHARACTERISTICS (LNA, with test circuit)

Output Power, IM3 vs. Input Power

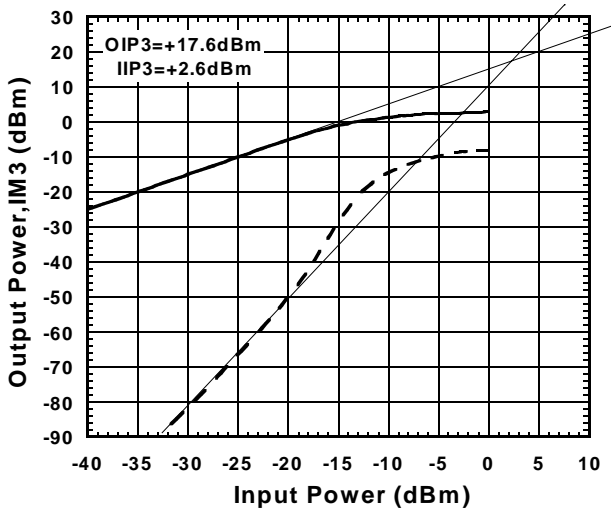

Condition
 $f=850+850.1\text{MHz}$
 $V_{\text{LNA}}=2.8\text{V}, V_{\text{CONT}}=1.9\text{V}$
 $V_{\text{MIX}}=V_{\text{LO}}=0\text{V}$

Output Power, IM3 vs. Input Power

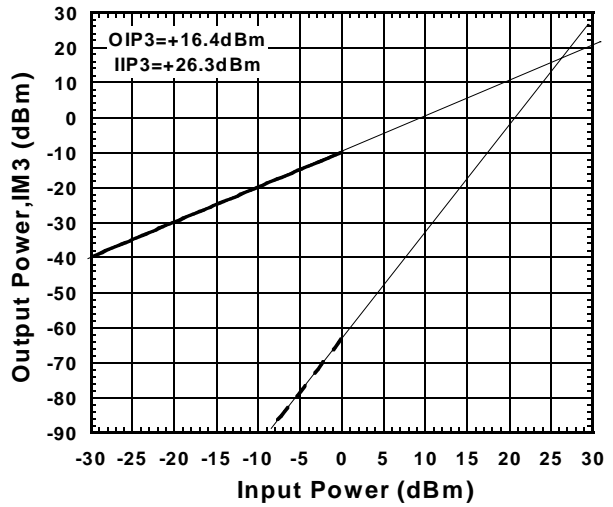

Condition
 $f=850+850.1\text{MHz}$
 $V_{\text{LNA}}=2.8\text{V}, V_{\text{CONT}}=0.1\text{V}$
 $V_{\text{MIX}}=V_{\text{LO}}=0\text{V}$

OIP3,IIP3 vs. Frequency

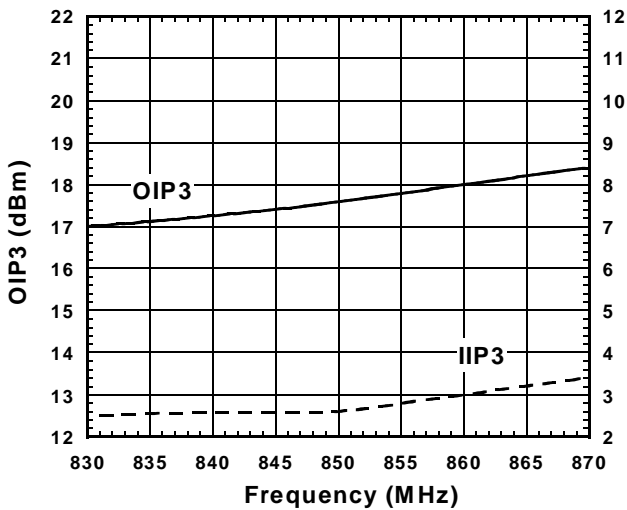

Condition
 $f=830\sim 870\text{MHz}$
 $f_{\text{OFFSET}}=100\text{kHz}$
 $P_{\text{in}}=-30\text{dBm}$
 $V_{\text{LNA}}=2.8\text{V}, V_{\text{CONT}}=1.9\text{V}$
 $V_{\text{MIX}}=V_{\text{LO}}=0\text{V}$

$OIP3=(3 \times P_{\text{out}} - IM3)/2$
 $IIP3=OIP3 - \text{Gain}$

OIP3,IIP3 vs. Frequency

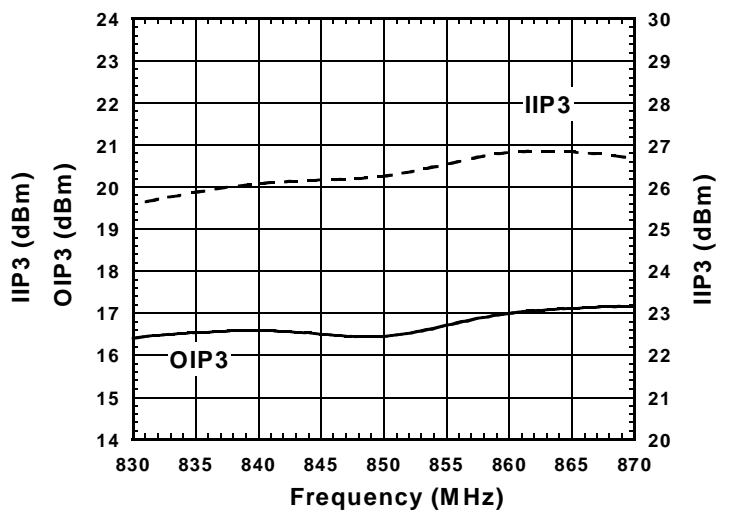

Condition
 $f=830\sim 870\text{MHz}$
 $f_{\text{OFFSET}}=100\text{kHz}$
 $P_{\text{in}}=-10\text{dBm}$
 $V_{\text{LNA}}=2.8\text{V}, V_{\text{CONT}}=0.1\text{V}$
 $V_{\text{MIX}}=V_{\text{LO}}=0\text{V}$

NJG1712KC1

■ TYPICAL CHARACTERISTICS (LNA, with test circuit)

Gain, NF vs. V_{CONT}

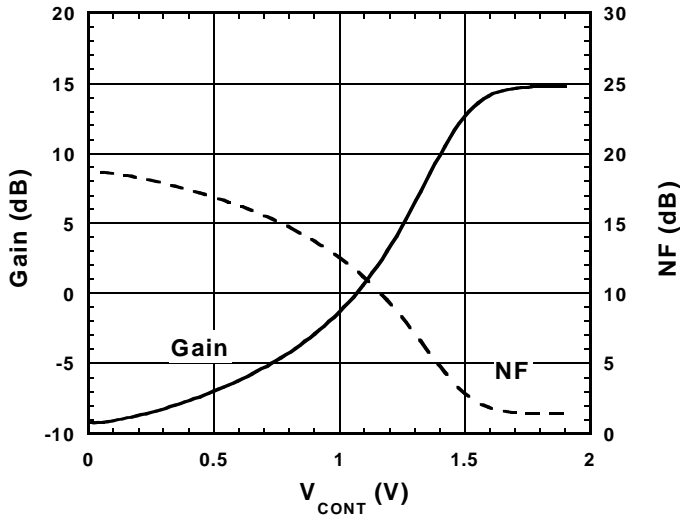

Condition
 $f=850\text{MHz}$
 $V_{LNA}=2.8\text{V}$
 $V_{MIX}=V_{LO}=0\text{V}$

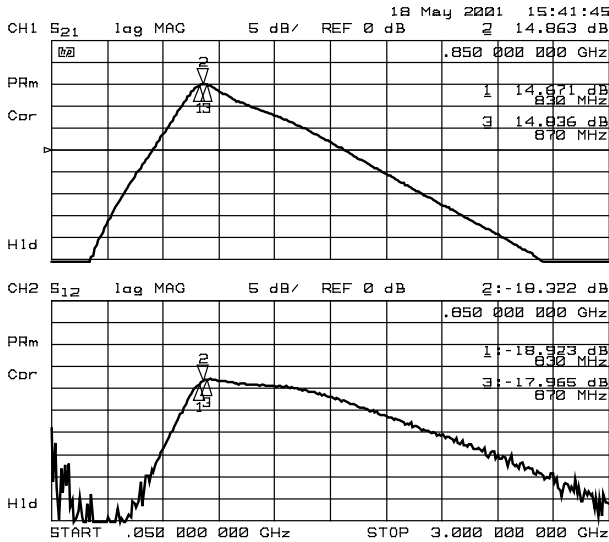

S21&S12
 Condition
 $V_{LNA}=2.8\text{V}$, $V_{CONT}=1.9\text{V}$
 $V_{MIX}=V_{LO}=0\text{V}$

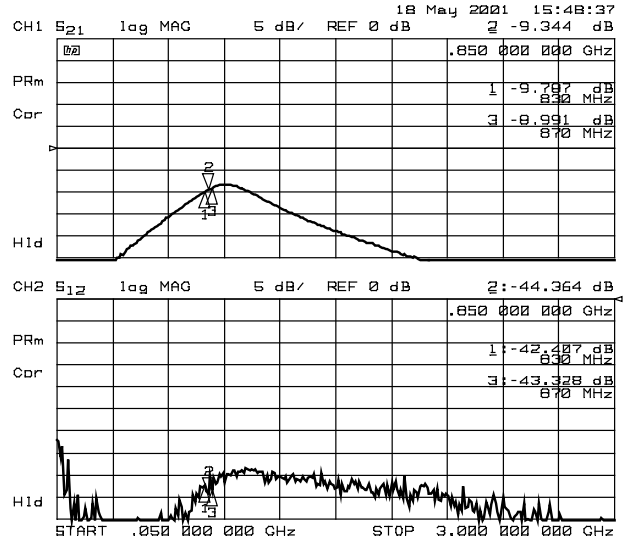

S21&S12
 Condition
 $V_{LNA}=2.8\text{V}$, $V_{CONT}=0.1\text{V}$
 $V_{MIX}=V_{LO}=0\text{V}$

TYPICAL CHARACTERISTICS (LNA, with test circuit)

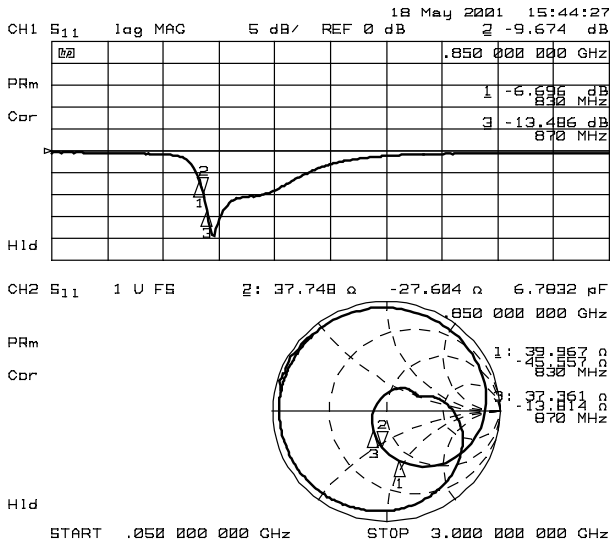

RF IN port Impedance
Condition
 $V_{LNA}=2.8V$, $V_{CONT}=1.9V$
 $V_{MIX}=V_{LO}=0V$

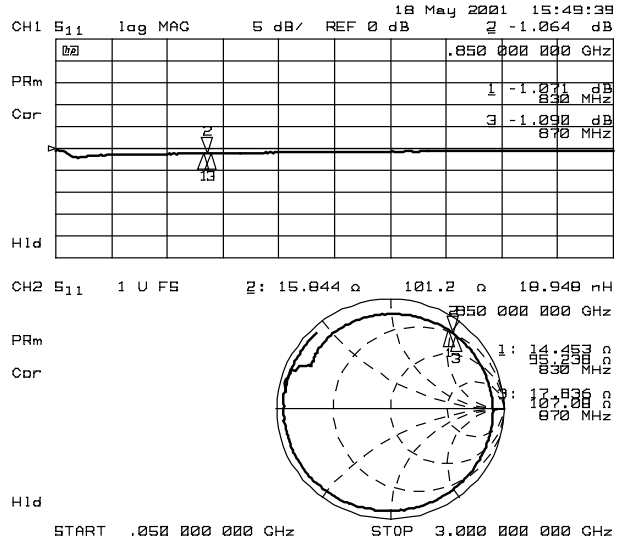

RF IN port Impedance
Condition
 $V_{LNA}=2.8V$, $V_{CONT}=0.1V$
 $V_{MIX}=V_{LO}=0V$

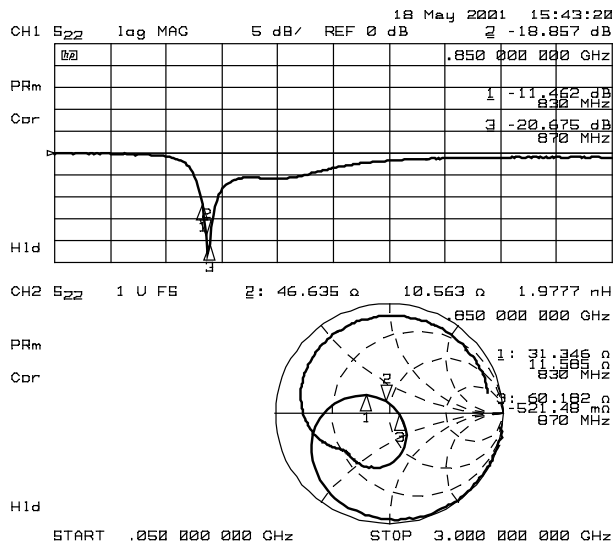

RF OUT port Impedance
Condition
 $V_{LNA}=2.8V$, $V_{CONT}=1.9V$
 $V_{MIX}=V_{LO}=0V$

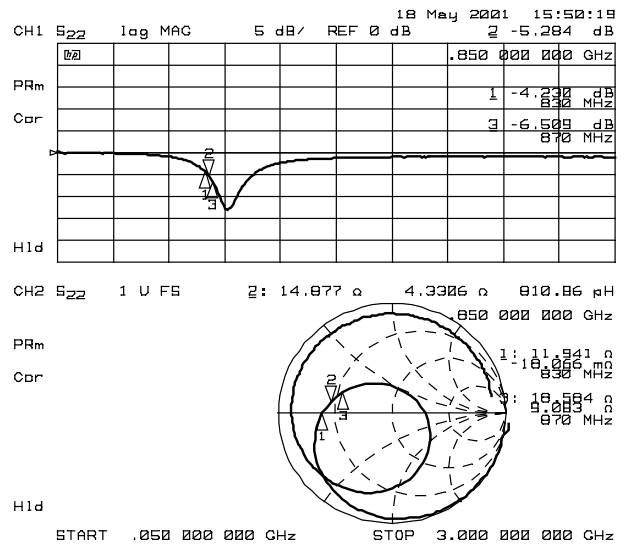

RF OUT port Impedance
Condition
 $V_{LNA}=2.8V$, $V_{CONT}=0.1V$
 $V_{MIX}=V_{LO}=0V$

NJG1712KC1

TYPICAL CHARACTERISTICS (LNA, with test circuit)

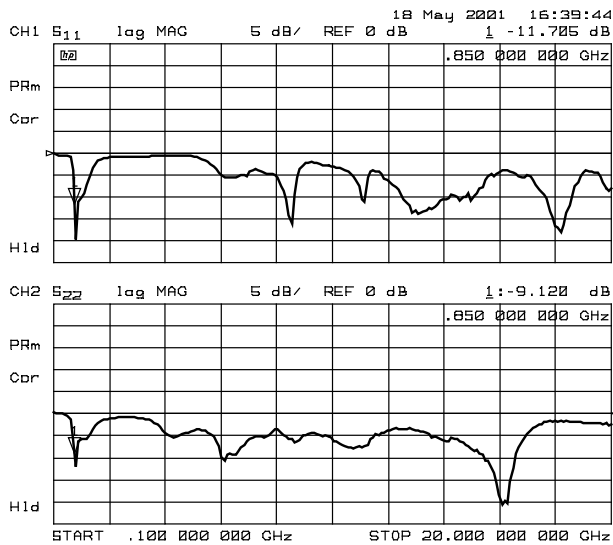

S₁₁&S₂₂ (~20GHz)
 Condition
 $V_{LNA}=2.8V$, $V_{CONT}=1.9V$
 $V_{MIX}=V_{LO}=0V$

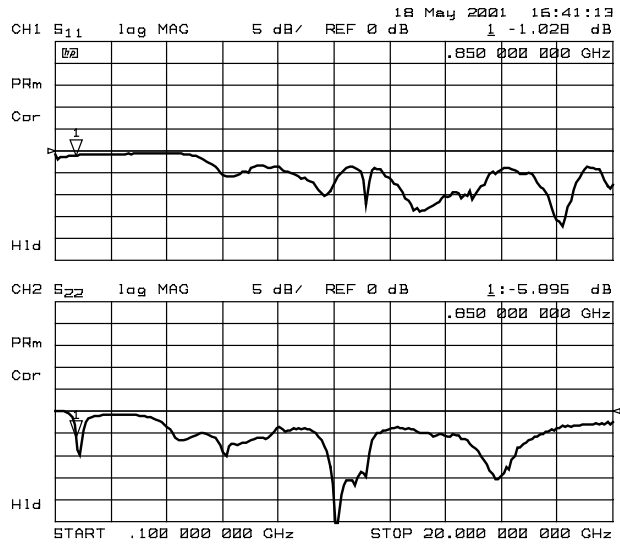

S₁₁&S₂₂ (~20GHz)
 Condition
 $V_{LNA}=2.8V$, $V_{CONT}=0.1V$
 $V_{MIX}=V_{LO}=0V$

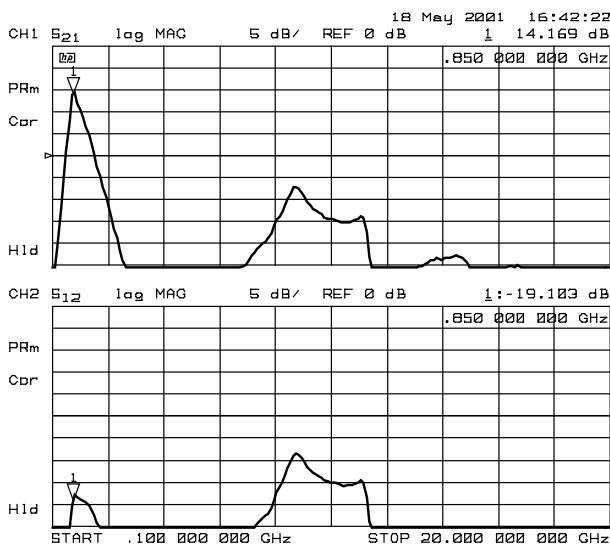

S₂₁&S₁₂ (~20GHz)
 Condition
 $V_{LNA}=2.8V$, $V_{CONT}=1.9V$
 $V_{MIX}=V_{LO}=0V$

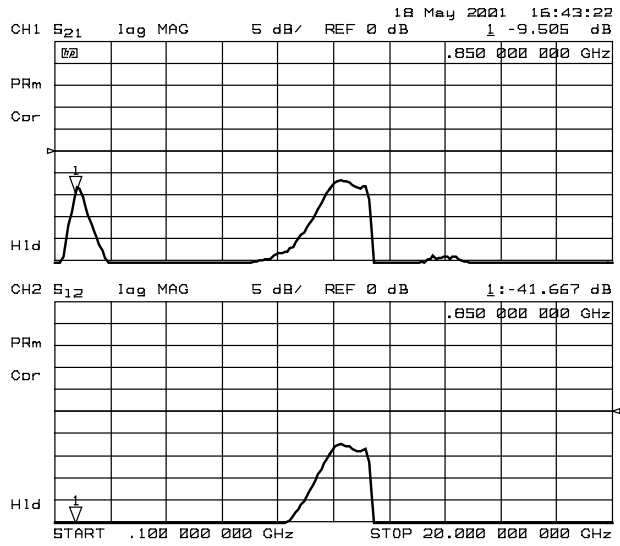

S₂₁&S₁₂ (~20GHz)
 Condition
 $V_{LNA}=2.8V$, $V_{CONT}=0.1V$
 $V_{MIX}=V_{LO}=0V$

■ TYPICAL CHARACTERISTICS (LNA, with test circuit)

Gain vs. V_{CONT} (Variable T_a)

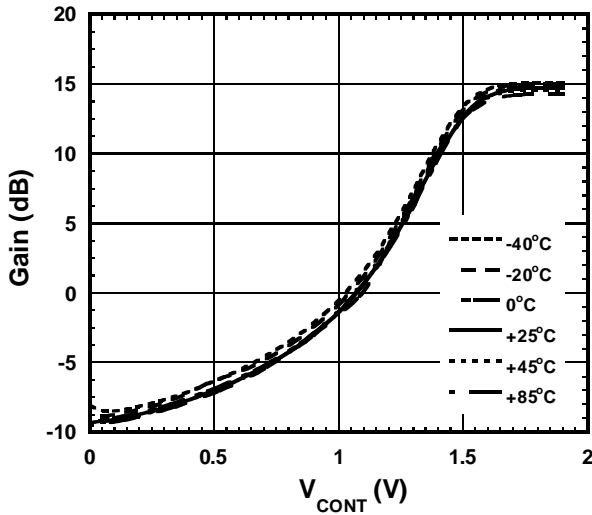

Condition
 $f=850\text{MHz}$
 $V_{LNA}=2.8\text{V}$
 $V_{MIX}=V_{LO}=0\text{V}$

Gain vs. T_a (Variable V_{CONT})

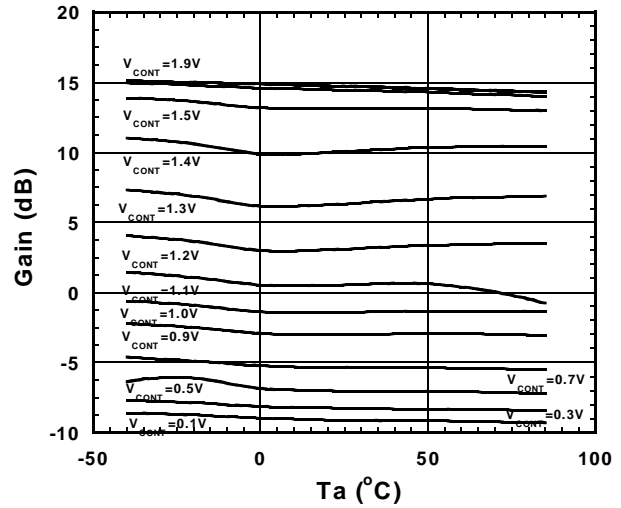

Condition
 $f=850\text{MHz}$
 $V_{LNA}=2.8\text{V}$
 $V_{MIX}=V_{LO}=0\text{V}$

Gain, NF vs. T_a

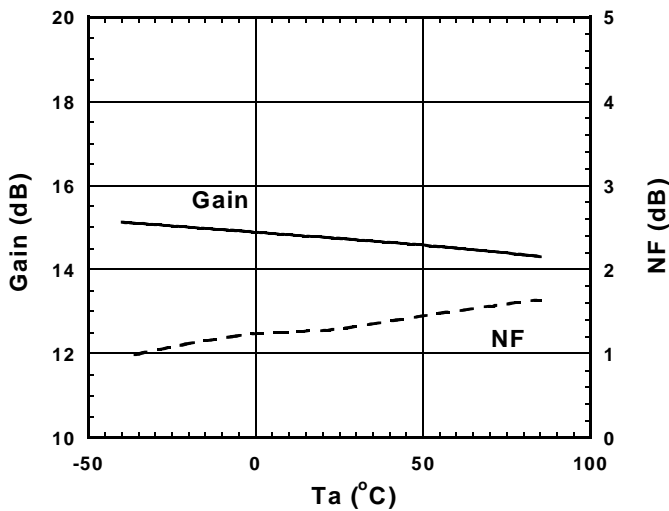

Condition
 $f=850\text{MHz}$
 $V_{LNA}=2.8\text{V}, V_{CONT}=1.9\text{V}$
 $V_{MIX}=V_{LO}=0\text{V}$

Gain, NF vs. T_a

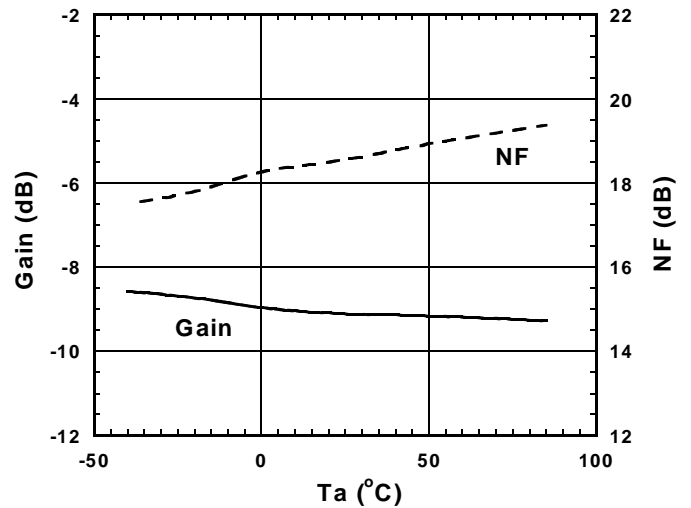

Condition
 $f=850\text{MHz}$
 $V_{LNA}=2.8\text{V}, V_{CONT}=0.1\text{V}$
 $V_{MIX}=V_{LO}=0\text{V}$

NJG1712KC1

■ TYPICAL CHARACTERISTICS (LNA, with test circuit)

OIP3, IIP3 vs. Ta

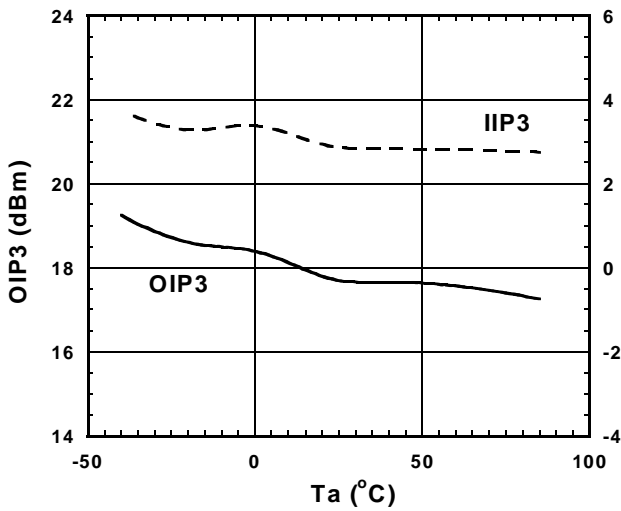

Condition
 $f=850+850.1\text{MHz}$
 $\text{Pin}=-10\text{dBm}$
 $V_{\text{LNA}}=2.8\text{V}, V_{\text{CONT}}=1.9\text{V}$
 $V_{\text{MIX}}=V_{\text{LO}}=0\text{V}$

OIP3, IIP3 vs. Ta

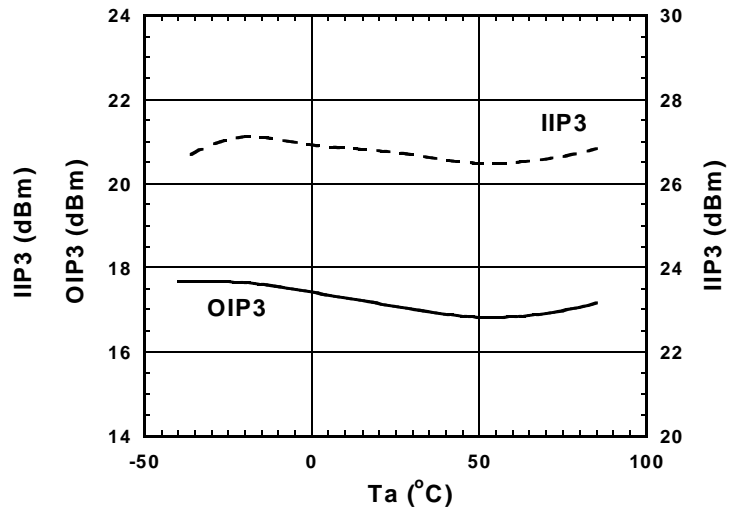

Condition
 $f=850+850.1\text{MHz}$
 $\text{Pin}=-10\text{dBm}$
 $V_{\text{LNA}}=2.8\text{V}, V_{\text{CONT}}=0.1\text{V}$
 $V_{\text{MIX}}=V_{\text{LO}}=0\text{V}$

I_{LNA} vs. Ta

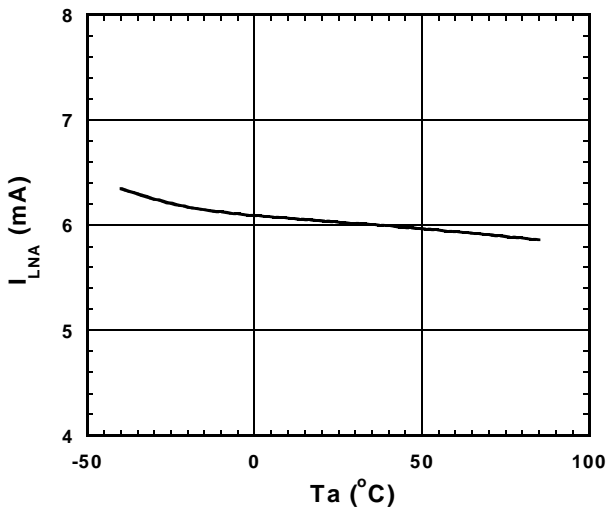

Condition
 $V_{\text{LNA}}=2.8\text{V}, V_{\text{CONT}}=1.9\text{V}$
 $V_{\text{MIX}}=V_{\text{LO}}=0\text{V}$

■ TYPICAL CHARACTERISTICS (MIXER, with test circuit)

Gc, NF vs. RF Frequency

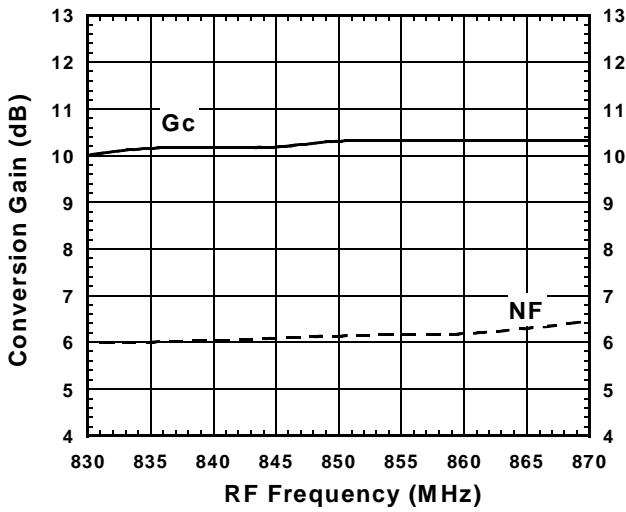

Condition
 $f_{IF}=110\text{MHz}$
 $f_{RF}=830\sim 870\text{MHz}$, $P_{RF}=-25\text{dBm}$
 Lower LOCAL, $P_{LO}=-10\text{dBm}$
 $V_{LNA}=V_{CONT}=0\text{V}$
 $V_{MIX}=V_{LO}=2.8\text{V}$

Gc, NF vs. LO Power

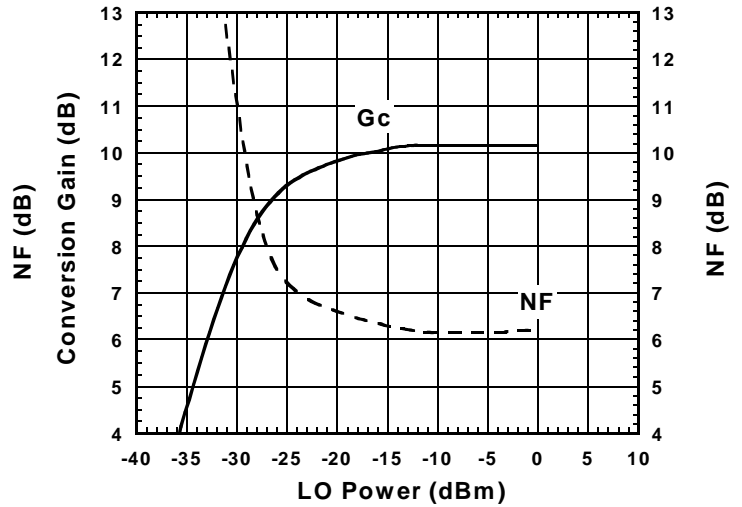

Condition
 $f_{IF}=110\text{MHz}$
 $f_{RF}=850\text{MHz}$, $P_{RF}=-25\text{dBm}$
 $f_{LO}=740\text{MHz}$
 $V_{LNA}=V_{CONT}=0\text{V}$
 $V_{MIX}=V_{LO}=2.8\text{V}$

OIP3, IIP3 vs. RF Frequency

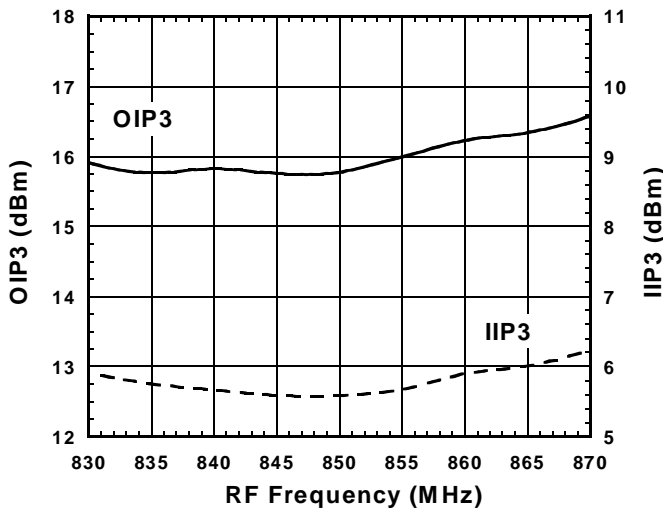

Condition
 $f_{IF}=110\text{MHz}$
 $f_{RF}=830\sim 870\text{MHz}$, $P_{RF}=-25\text{dBm}$
 $f_{RF\ OFFSET}=100\text{kHz}$
 Lower LOCAL, $P_{LO}=-10\text{dBm}$
 $V_{LNA}=V_{CONT}=0\text{V}$
 $V_{MIX}=V_{LO}=2.8\text{V}$

$$\text{OIP3} = (3 \times \text{IIP3} - \text{Gc}) / 2$$

$$\text{IIP3} = \text{OIP3} - \text{Gc}$$

OIP3, IIP3 vs. LO Power

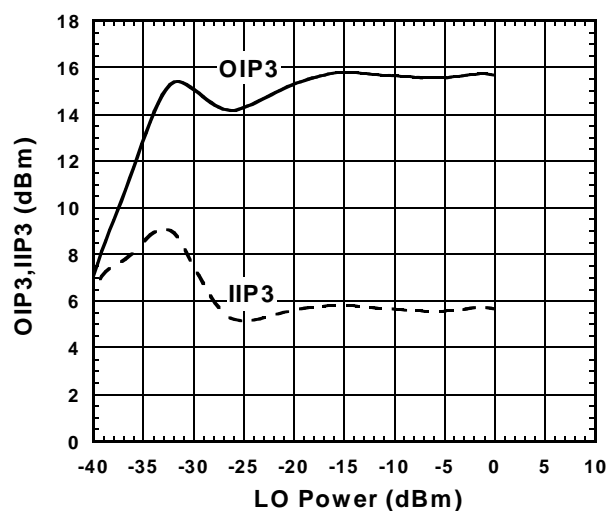

Condition
 $f_{IF}=110\text{MHz}$
 $f_{RF}=850+850.1\text{MHz}$, $P_{RF}=-25\text{dBm}$
 $f_{LO}=740\text{MHz}$
 $V_{LNA}=V_{CONT}=0\text{V}$
 $V_{MIX}=V_{LO}=2.8\text{V}$

TYPICAL CHARACTERISTICS (MIXER, with test circuit)

IF Output Power vs. RF Power

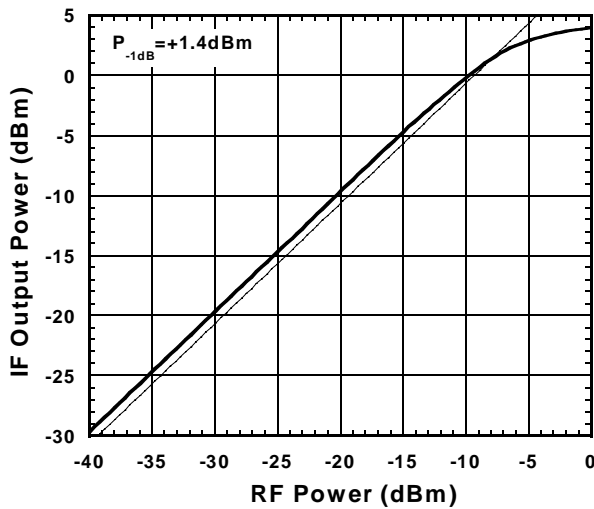

Condition
 $f_{IF}=110\text{MHz}$
 $f_{RF}=850\text{MHz}$
 $f_{LO}=740\text{MHz}, P_{LO}=-10\text{dBm}$
 $V_{LNA}=V_{CONT}=0\text{V}$
 $V_{MIX}=V_{LO}=2.8\text{V}$

IF,IM3 vs. RF Power

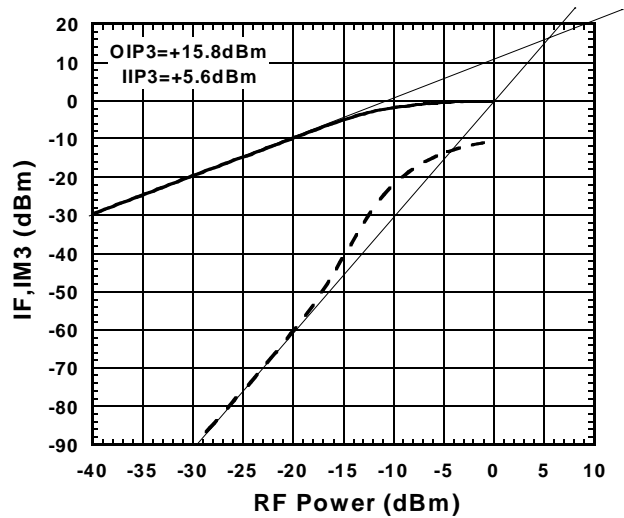

Condition
 $f_{IF}=110\text{MHz}$
 $f_{RF}=850+850.1\text{MHz}$
 $f_{LO}=740\text{MHz}, P_{LO}=-10\text{dBm}$
 $V_{LNA}=V_{CONT}=0\text{V}$
 $V_{MIX}=V_{LO}=2.8\text{V}$

LO Leakage vs. LO Frequency

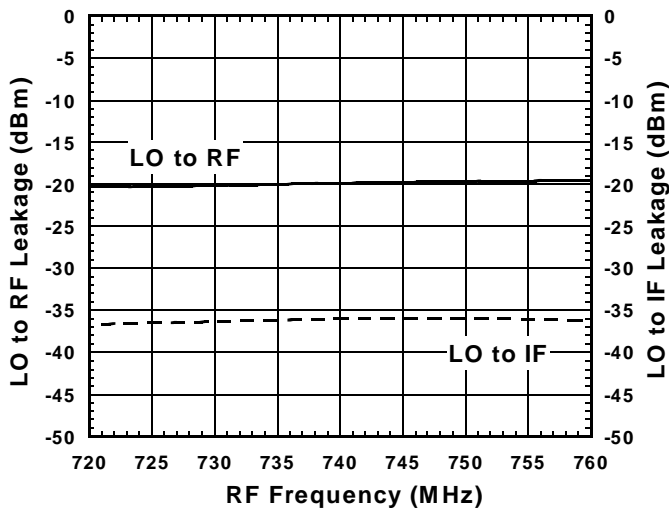

Condition
 $f_{LO}=720\sim 760\text{MHz}, P_{LO}=-10\text{dBm}$
 $V_{LNA}=V_{CONT}=0\text{V}$
 $V_{MIX}=V_{LO}=2.8\text{V}$

TYPICAL CHARACTERISTICS (MIXER, with test circuit)

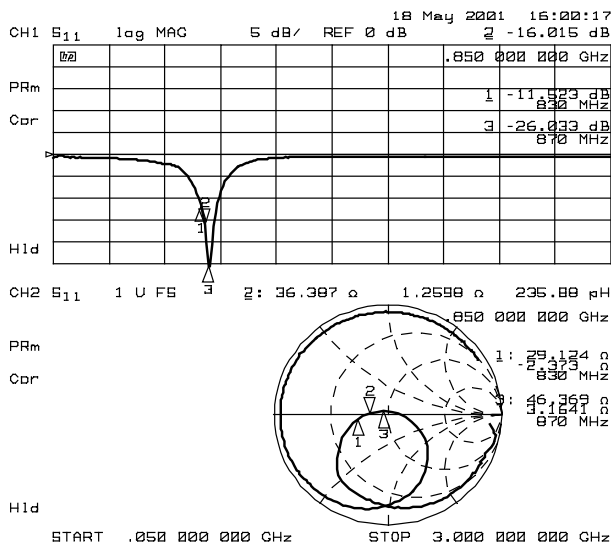

MIXER IN Impedance
 Condition
 LOCAL IN, IF OUT 50Ωterm.
 $V_{LNA}=V_{CONT}=0V$
 $V_{MIX}=V_{LO}=2.8V$

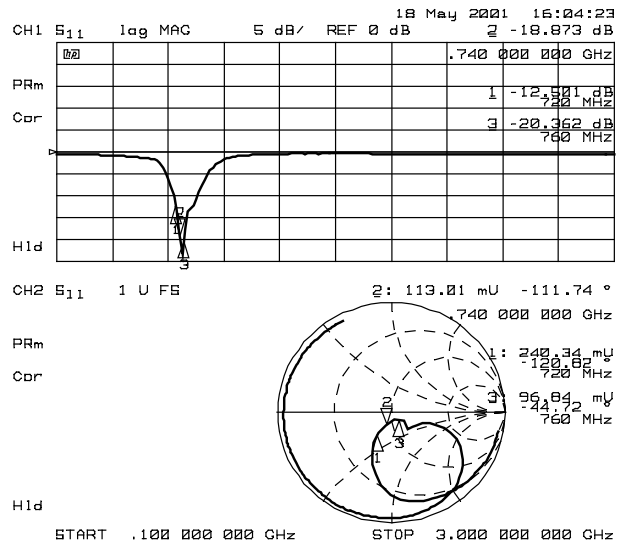

LOCAL IN Impedance
 Condition
 MIXER IN, IF OUT 50Ωterm.
 $V_{LNA}=V_{CONT}=0V$
 $V_{MIX}=V_{LO}=2.8V$

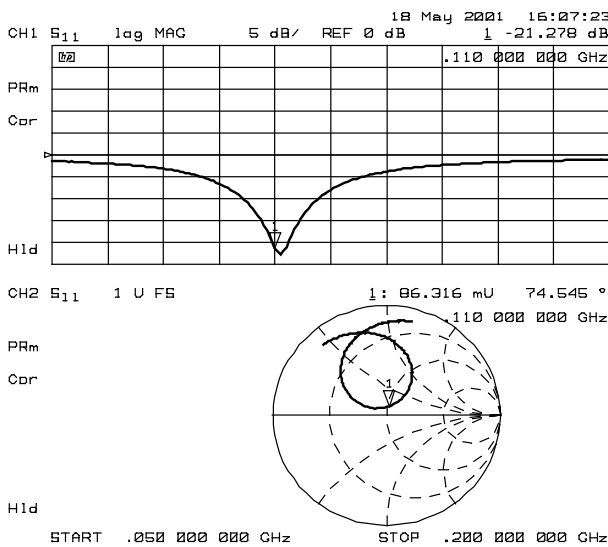

IF OUT Impedance
 Condition
 MIXER IN, LOCAL IN 50Ωterm.
 $V_{LNA}=V_{CONT}=0V$
 $V_{MIX}=V_{LO}=2.8V$

NJG1712KC1

TYPICAL CHARACTERISTICS (MIXER, with test circuit)

Conversion Gain vs. RF Frequency

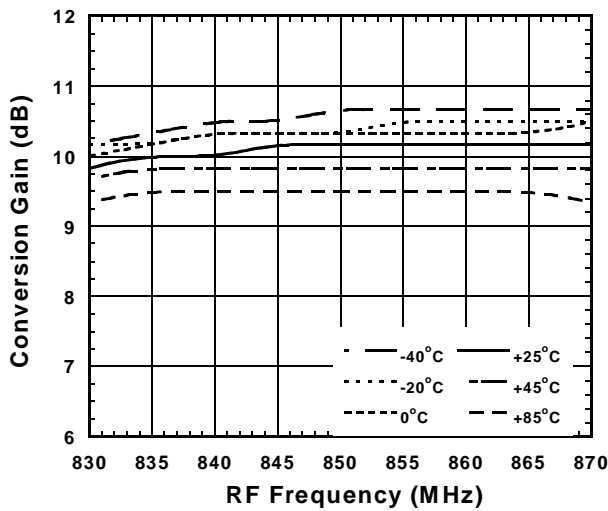

Condition
 $f_{IF}=110\text{MHz}$
 $f_{RF}=830\sim 870\text{MHz}$, $P_{RF}=-25\text{dBm}$
 Lower LOCAL, $P_{LO}=-10\text{dBm}$
 $V_{LNA}=V_{CONT}=0\text{V}$
 $V_{MIX}=V_{LO}=2.8\text{V}$

NF vs. RF Frequency

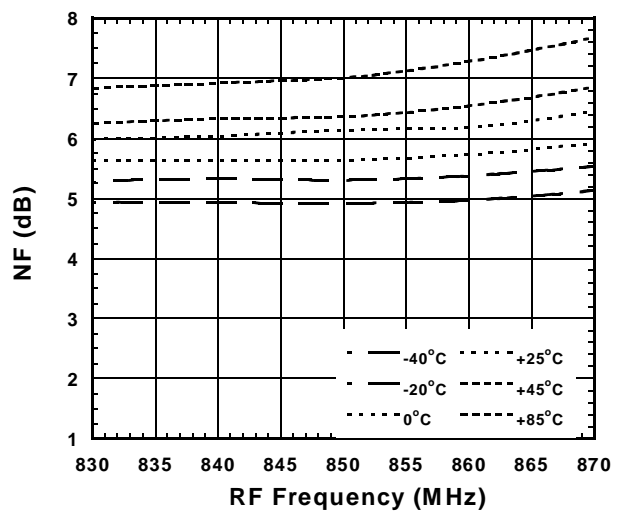

Condition
 $f_{IF}=110\text{MHz}$
 $f_{RF}=830\sim 870\text{MHz}$, $P_{RF}=-25\text{dBm}$
 Lower LOCAL, $P_{LO}=-10\text{dBm}$
 $V_{LNA}=V_{CONT}=0\text{V}$
 $V_{MIX}=V_{LO}=2.8\text{V}$

OIP3, IIP3 vs. RF Frequency

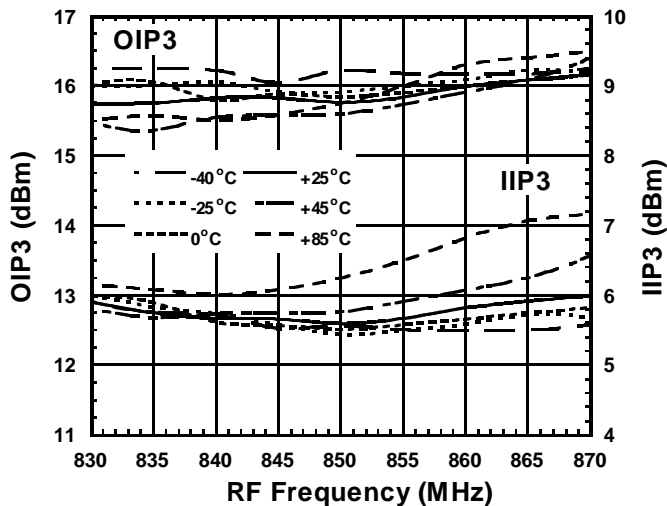

Condition
 $f_{IF}=110\text{MHz}$
 $f_{RF}=830\sim 870\text{MHz}$, $P_{RF}=-25\text{dBm}$
 $f_{RF\ OFFSET}=100\text{kHz}$
 Lower LOCAL, $P_{LO}=-10\text{dBm}$
 $V_{LNA}=V_{CONT}=0\text{V}$
 $V_{MIX}=V_{LO}=2.8\text{V}$

TYPICAL CHARACTERISTICS (MIXER, with test circuit)

Conversion Gain vs. Lo Power

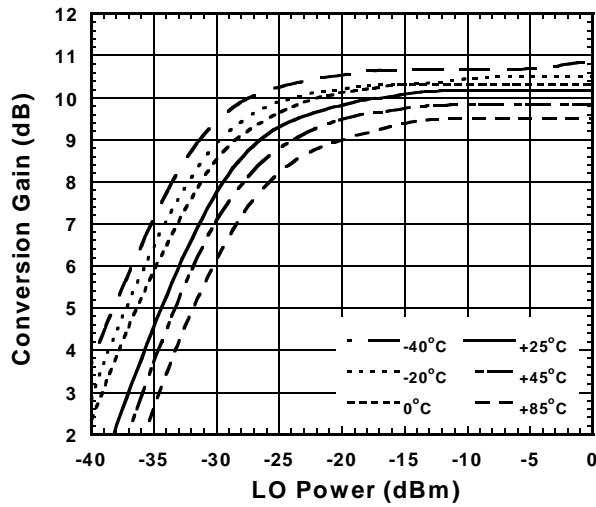

Condition
 $f_{IF}=110\text{MHz}$
 $f_{RF}=850\text{MHz}$, $P_{RF}=-25\text{dBm}$
 $f_{LO}=740\text{MHz}$
 $V_{LNA}=V_{CONT}=0\text{V}$
 $V_{MIX}=V_{LO}=2.8\text{V}$

NF vs. LO Power

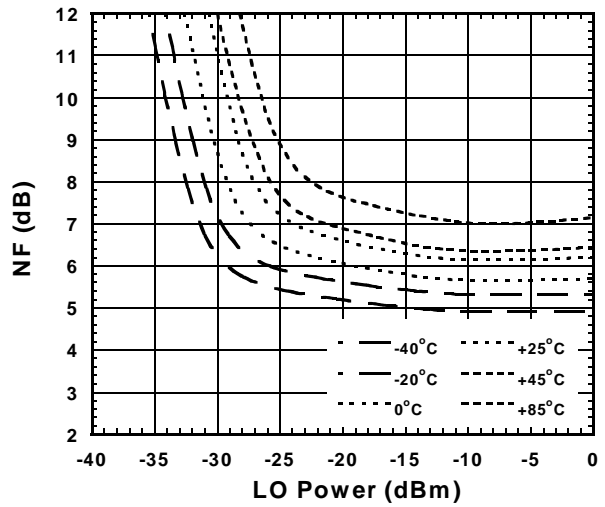

Condition
 $f_{IF}=110\text{MHz}$
 $f_{RF}=850\text{MHz}$, $P_{RF}=-25\text{dBm}$
 $f_{LO}=740\text{MHz}$
 $V_{LNA}=V_{CONT}=0\text{V}$
 $V_{MIX}=V_{LO}=2.8\text{V}$

IIP3 vs. LO Power

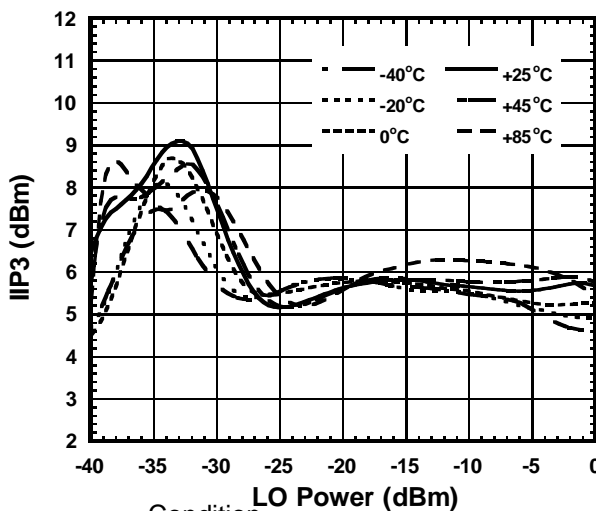

Condition
 $f_{IF}=110\text{MHz}$
 $f_{RF}=850+850.1\text{MHz}$, $P_{RF}=-25\text{dBm}$
 $f_{LO}=740\text{MHz}$
 $V_{LNA}=V_{CONT}=0\text{V}$
 $V_{MIX}=V_{LO}=2.8\text{V}$

I_{TOTAL} vs. T_a

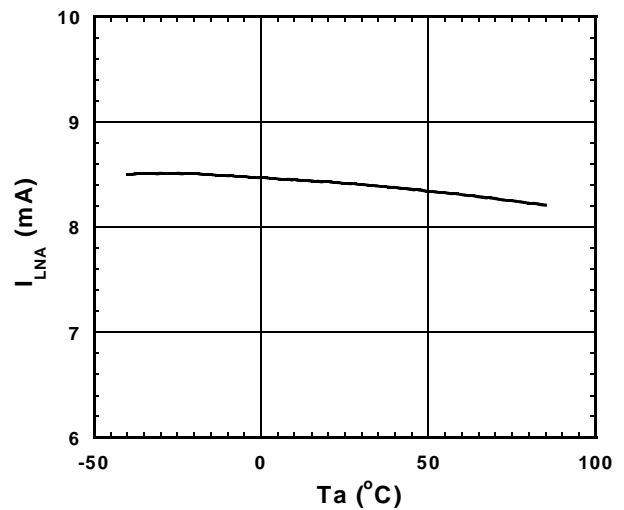

Condition
 $V_{LNA}=V_{CONT}=0\text{V}$
 $V_{MIX}=V_{LO}=2.8\text{V}$

NJG1712KC1

TEST CIRCUIT

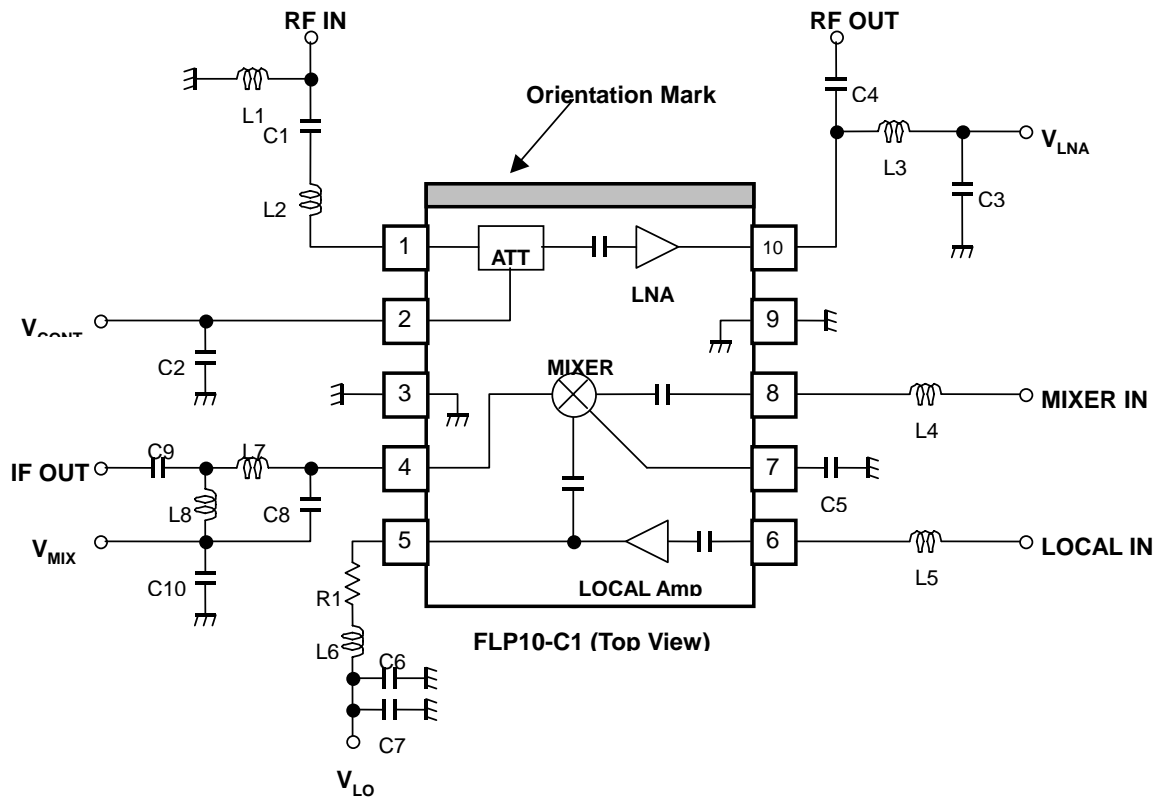

PART ID	850MHzBAND		COMMENT
	Lower LOCAL		
	$f_{LO}=740\text{MHz}$, $f_{IF}=110\text{MHz}$		
L1	12nH	TAIYO-YUDEN (HK1005)	
L2	18nH	TAIYO-YUDEN (HK1608)	
L3	12nH	TAIYO-YUDEN (HK1005)	
L4	33nH	TAIYO-YUDEN (HK1005)	
L5	47nH	TAIYO-YUDEN (HK1005)	
L6	33nH	TAIYO-YUDEN (HK1005)	
L7	150nH	TAIYO-YUDEN (HK1608)	
L8	68nH	TAIYO-YUDEN (HK1005)	
C1	1000pF	MURATA (GRM36)	
C2	1000pF	MURATA (GRM36)	
C3	0.01uF	MURATA (GRM36)	
C4	1.5pF	MURATA (GRM36)	
C5	100pF	MURATA (GRM36)	
C6	100pF	MURATA (GRM36)	
C7	0.01uF	MURATA (GRM36)	
C8	8pF	MURATA (GRM36)	
C9	1000pF	MURATA (GRM36)	
C10	0.01uF	MURATA (GRM36)	
R1	10 Ω	1005 Size	

RECOMMENDED PCB DESIGN

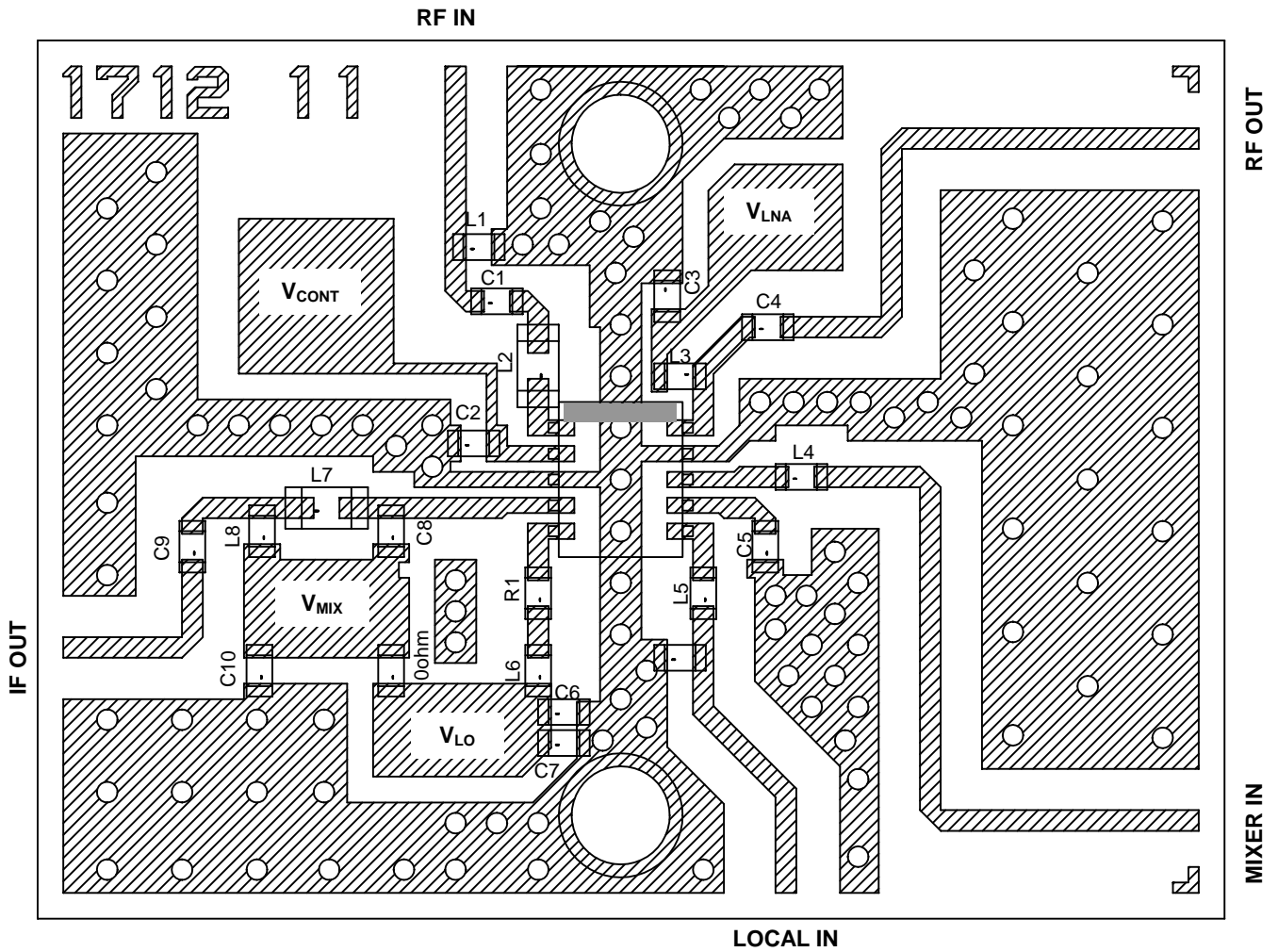

PCB (FR-4): t=0.2mm

MICRO STRIPLINE WIDTH=0.4mm ($Z_0=50\Omega$)

PCB SIZE=23.0x17.0 mm

NJG1712KC1

PACKAGE OUTLINE (FLP10-C1)

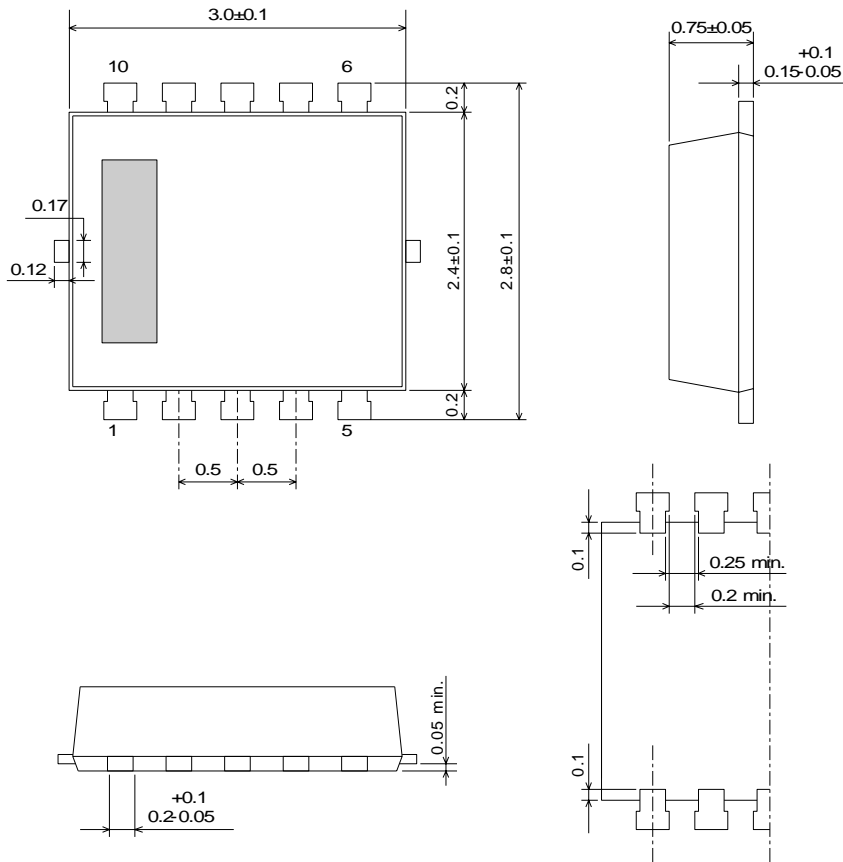

Lead material : Copper
 Lead surface finish : Solder plating
 Molding material : Epoxy resin
 UNIT : mm
 Weight : 15mg

Cautions on using this product

This product contains Gallium-Arsenide (GaAs) which is a harmful material.

- Do NOT eat or put into mouth.
- Do NOT dispose in fire or break up this product.
- Do NOT chemically make gas or powder with this product.
- To waste this product, please obey the relating law of your country.

[CAUTION]

The specifications on this databook are only given for information, without any guarantee as regards either mistakes or omissions. The application circuits in this databook are described only to show representative usages of the product and not intended for the guarantee or permission of any right including the industrial rights.

This product may be damaged with electric static discharge (ESD) or spike voltage. Please handle with care to avoid these damages.