

Micro-Power Voltage Detectors

General Description

The RT9808 is a micro-power voltage detector supervising the power supply voltage level for microprocessors (μP) or digital systems. It provides internally fixed threshold levels with 0.1V per step ranging from 1.5V to 5V, which covers most digital applications. It features low supply current of $3\mu\text{A}$.

The RT9808 performs supervisory function by sending out a reset signal whenever the VDD voltage falls below a preset threshold level. This reset signal will last the whole period before VDD recovering. Once VDD recovered up-crossing the threshold level, the reset signal will be released if VDD is above threshold and last for the whole period of reset active time out.

RT9808 is n-channel, open-drain output.

Applications

- Computers
- Controllers
- Intelligent Instruments
- Critical μP and μC Power Monitoring
- Portable/Battery-Powered Equipment

Ordering Information

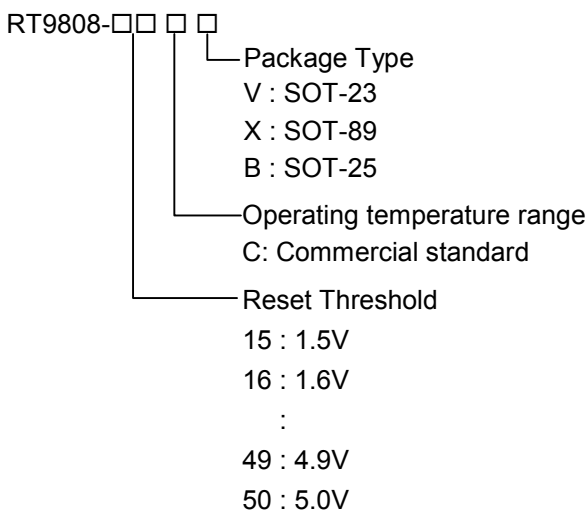

Features

- Internally Fixed Threshold 1.5V to 5V in 0.1V Step
- $\pm 2\%$ Accuracy
- Low Supply Current $3\mu\text{A}$
- Quick Reset within $20\mu\text{s}$
- Built-in Recovery Delay 200mS
- Low Functional Supply Voltage 0.9V
- N-Channel Open Drain Output
- Small 3-Pin SOT-23/SOT89 and 5-Pin SOT-25 Packages

Pin Configurations

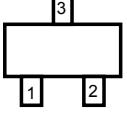
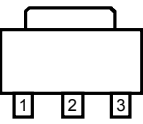
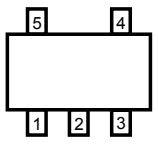
Part Number	Pin Configurations
RT9808-□□CV (Plastic SOT-23)	 <p>TOP VIEW</p> <ol style="list-style-type: none"> 1. $\overline{\text{RESET}}$ 2. GND 3. VDD
RT9808-□□CX (Plastic SOT-89)	 <p>TOP VIEW</p> <ol style="list-style-type: none"> 1. $\overline{\text{RESET}}$ 2. VDD 3. GND
RT9808-□□CB (Plastic SOT-25)	 <p>TOP VIEW</p> <ol style="list-style-type: none"> 1. $\overline{\text{RESET}}$ 2. VDD 3. GND 4. NC 5. NC

Typical Application Circuit

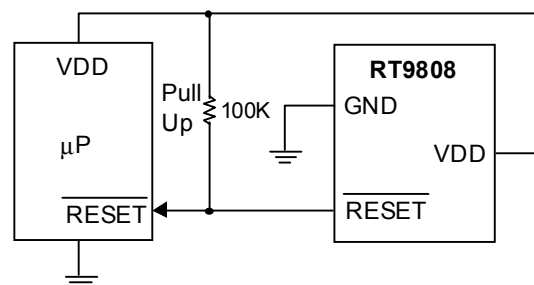

Pin Description

Pin Name	Pin Function
GND	Ground Pin
$\overline{\text{RESET}}$	Reset Pulse Output, Negative Pulse
VDD	Power Pin
NC	No Connected

Function Block Diagram

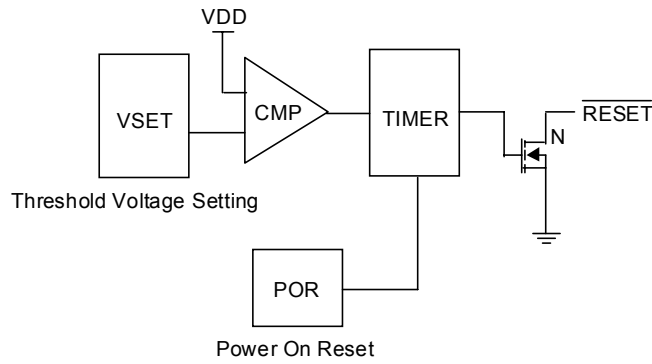

Absolute Maximum Ratings

- Terminal Voltage (with Respect to GND)
 - VDD ----- -0.3V to 6.0V
 - All Other Inputs ----- -0.3V to VDD+0.3V
- Input Current, VDD ----- 20mA
- Output Current, $\overline{\text{RESET}}$ ----- 20mA
- Power Dissipation, $P_D @ T_A = 25^\circ\text{C}$
 - SOT-23 ----- 0.25W
 - SOT-89 ----- 0.5W
 - SOT-25 ----- 0.25W
- Operating Junction Temperature Range ----- $-40^\circ\text{C} \sim 125^\circ\text{C}$
- Storage Temperature Range ----- $-65^\circ\text{C} \sim 125^\circ\text{C}$
- Package Thermal Resistance
 - SOT-23, θ_{JA} ----- 250°C/W
 - SOT-89, θ_{JC} ----- 100°C/W
 - SOT-89, θ_{JA} ----- 300°C/W
 - SOT-25, θ_{JA} ----- 250°C/W
- Lead Temperature (Soldering, 5sec.) ----- 260°C

Electrical Characteristics

(VDD = 3.0, unless specified)

Parameter	Symbol	Test Conditions	Min	Typ	Max	Units
Operating VDD (V_{OUT}) Range	V_{DD}		0.9	--	6	V
Supply Current	I_{DD}	$V_{DD} = 1.5V \sim 5V, I_{OUT} = 0$	--	3	--	μA
Reset Threshold	V_{TH}	$T_A = 27^\circ\text{C}$	--	Note1	--	V
Threshold Voltage Accuracy	ΔV_{TH}	$T_A = 27^\circ\text{C}$	--	--	2	%
VCC Drop to Reset Delay	t_{RD}	Drop = -125mV	--	--	20	μS
Reset Active Time Out Period	t_{RP}	$V_{DD} \geq 1.02 \times V_{TH}$	--	200	--	mS
$\overline{\text{RESET}}$ Output Voltage	V_{OL}	$V_{DD} < V_{TH}, I_{SINK} > 3.5\text{mA}$	--	0.4	--	V

Note1: 1.5V ~ 5V, step 0.1V

Measuring Circuit

(1) Detection Voltage

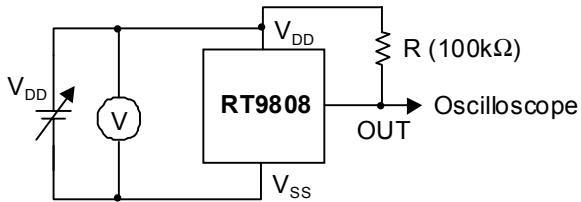

(3) Output Transistor Current

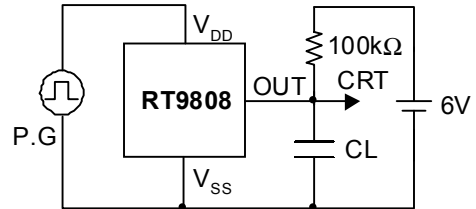

(2) Current Consumption

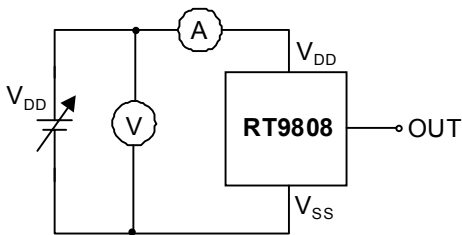

(4) Dynamic Response

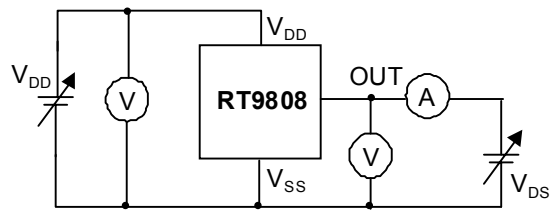

Typical Operating Characteristics

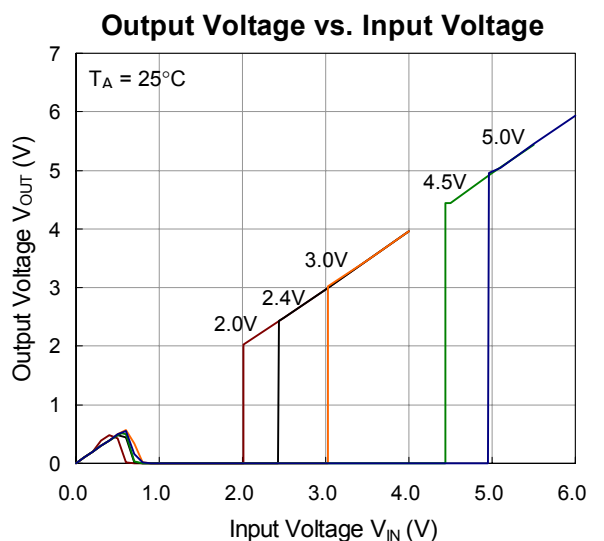
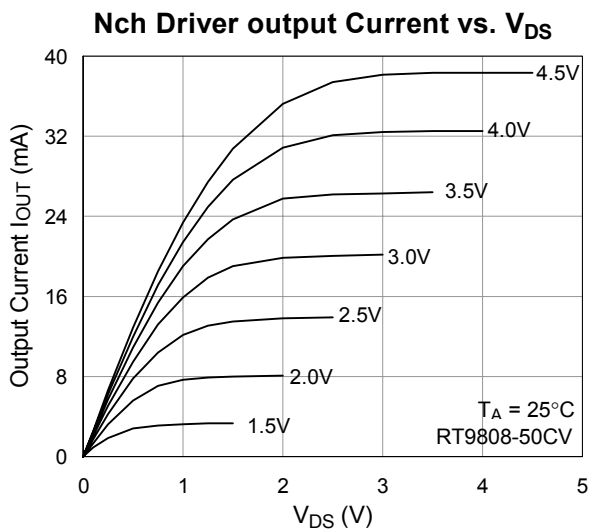
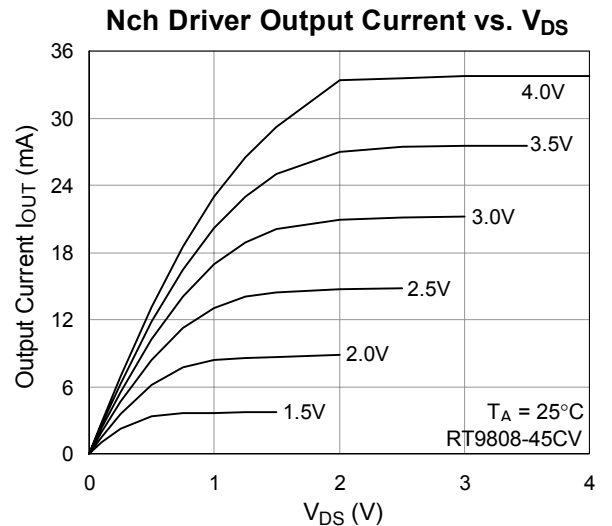
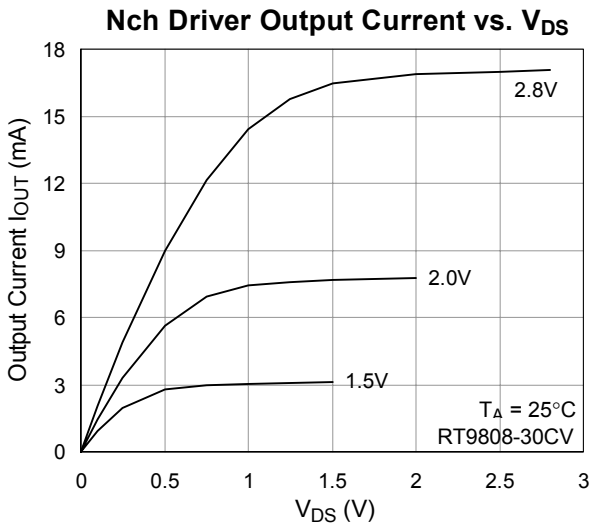
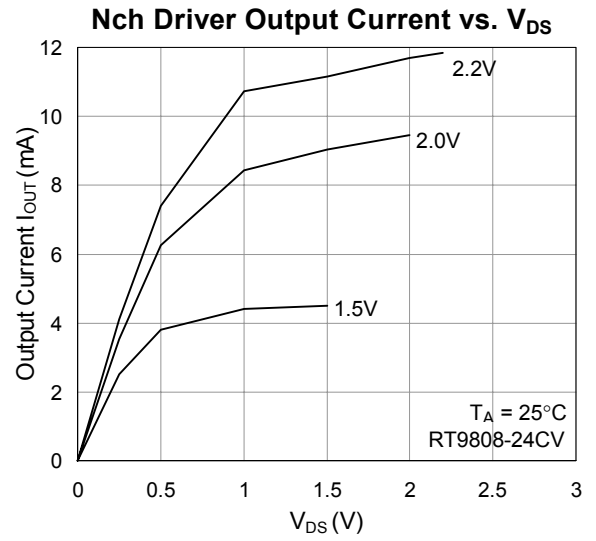
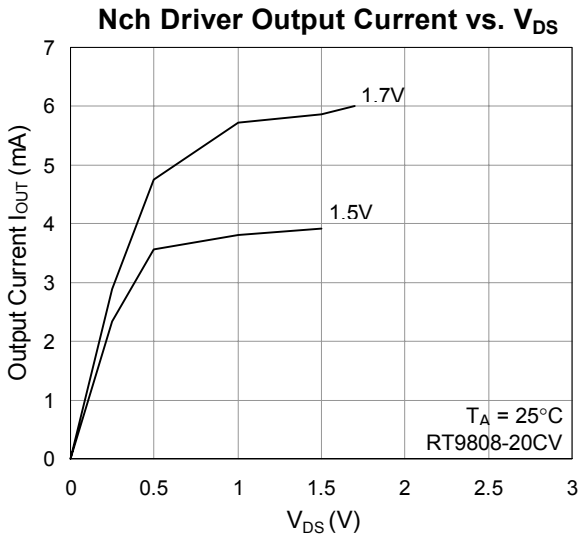

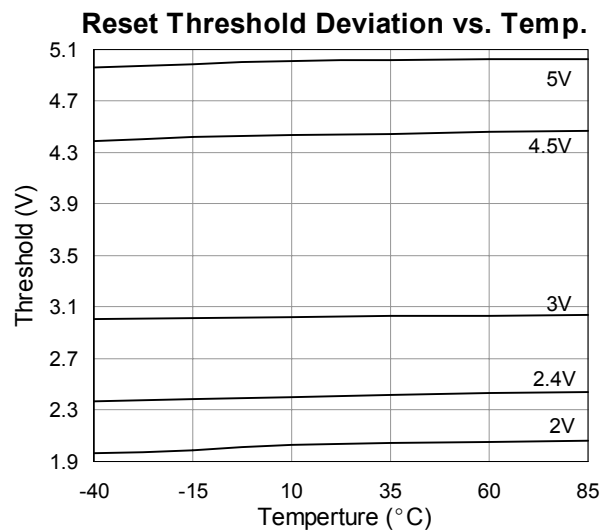
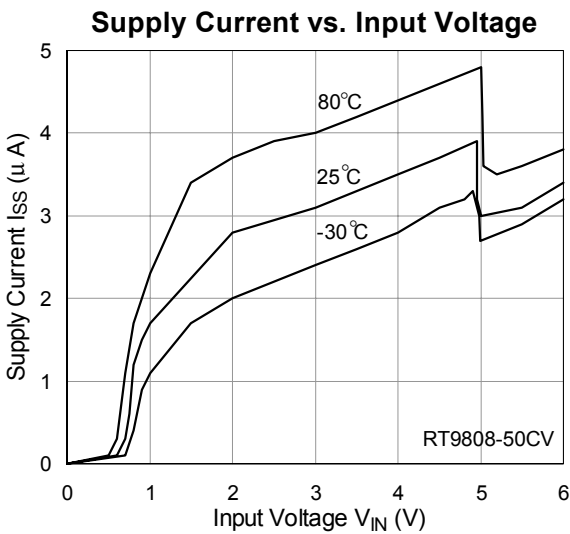
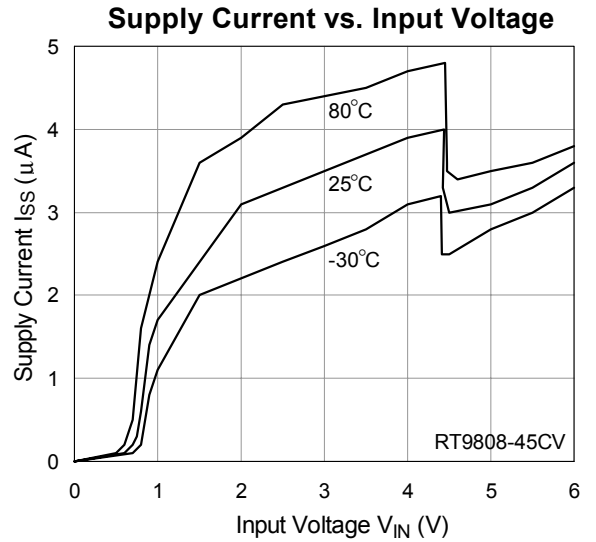
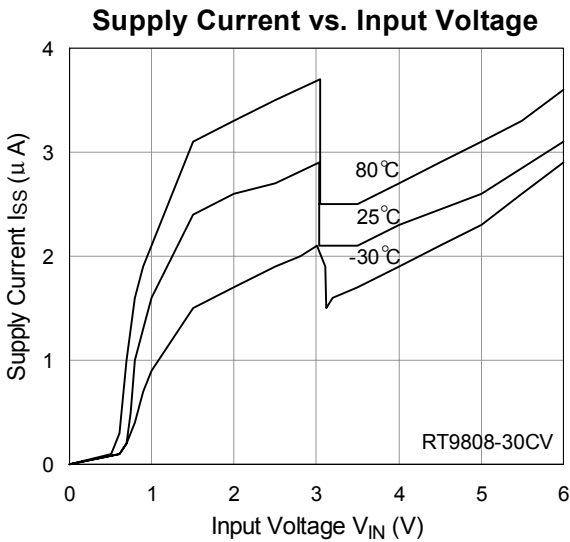
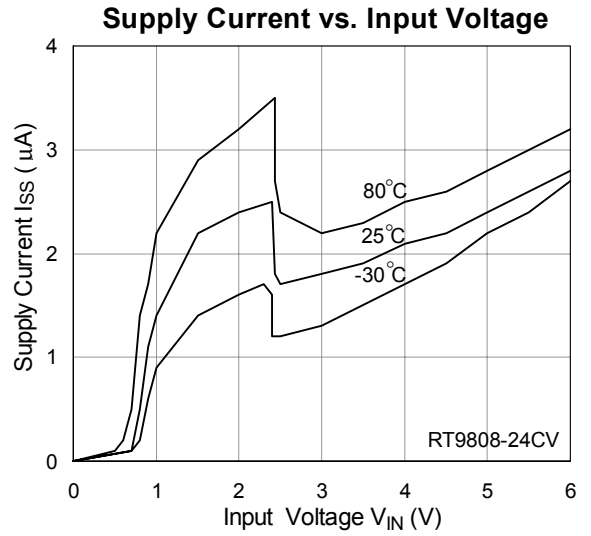
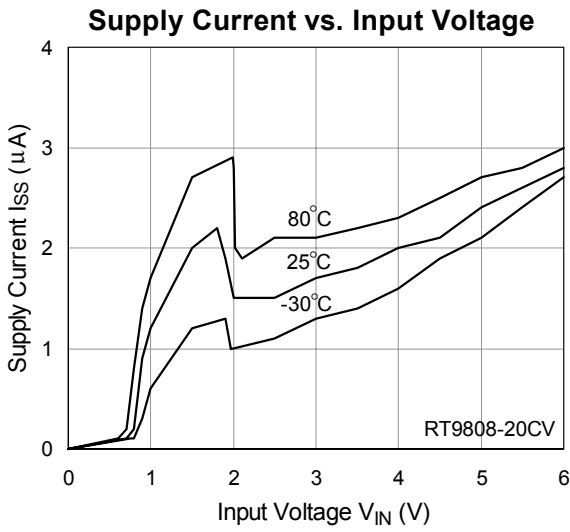

Nch Driver Output Current vs. Input Voltage

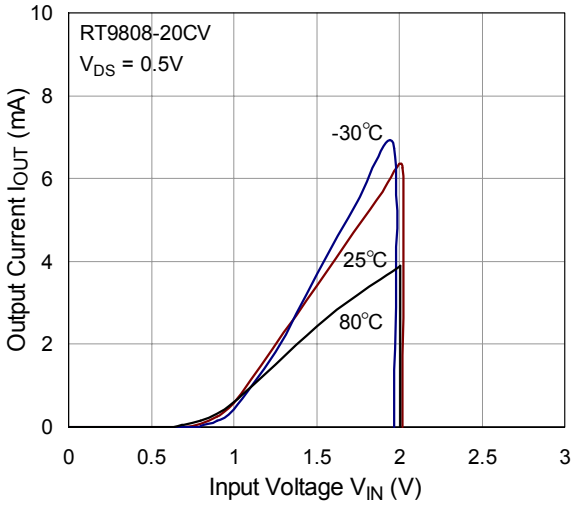

Nch Driver Output Current vs. Input Voltage

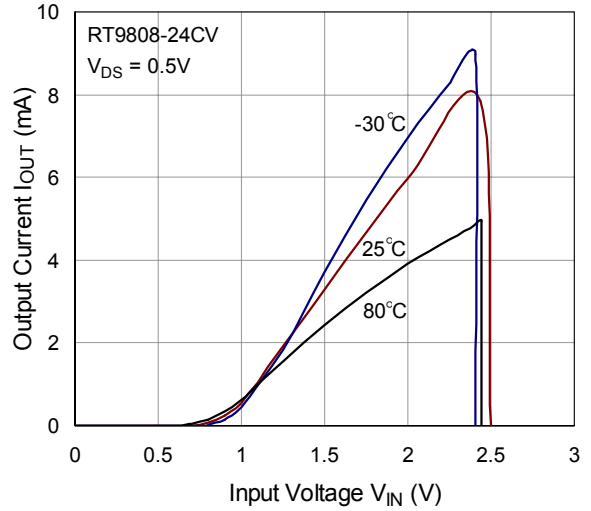

Nch Driver Output Current vs. Input Voltage

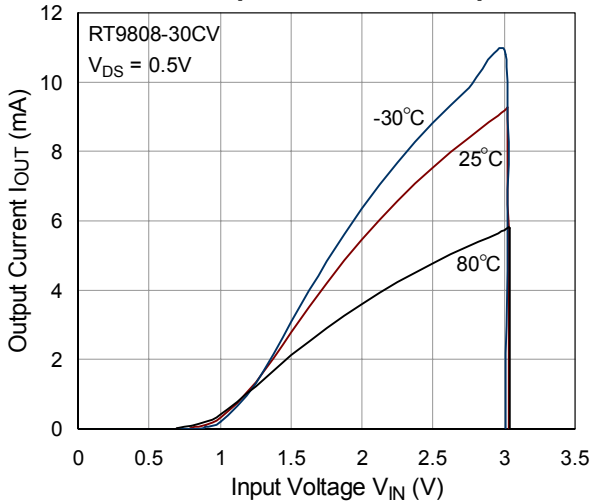

Nch Driver Output Current vs. Input Voltage

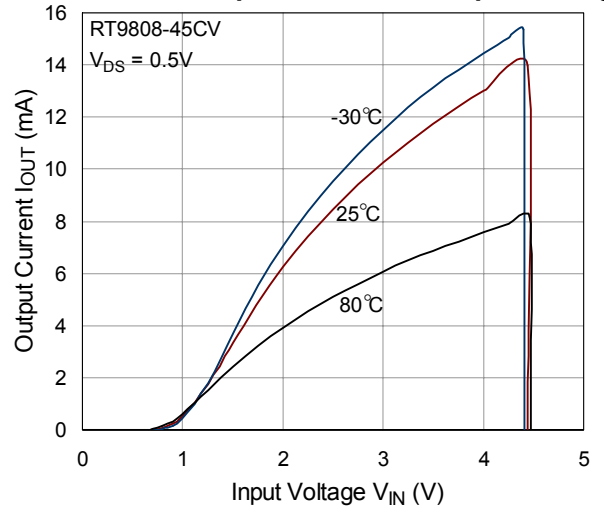

Nch Driver Output Current vs. Input Voltage

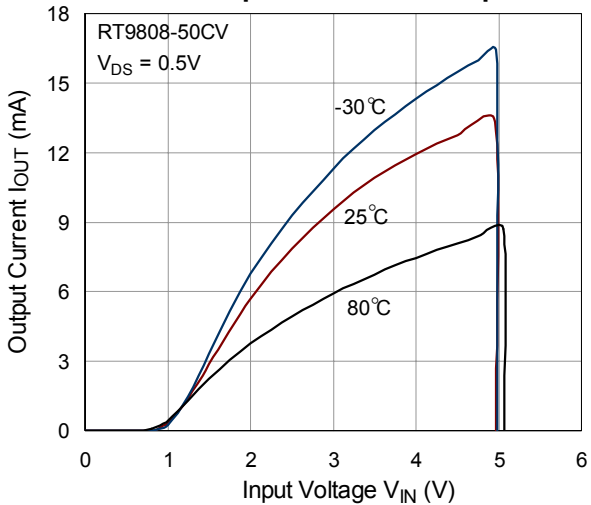

Power-Up reset Timeout vs. Temp.

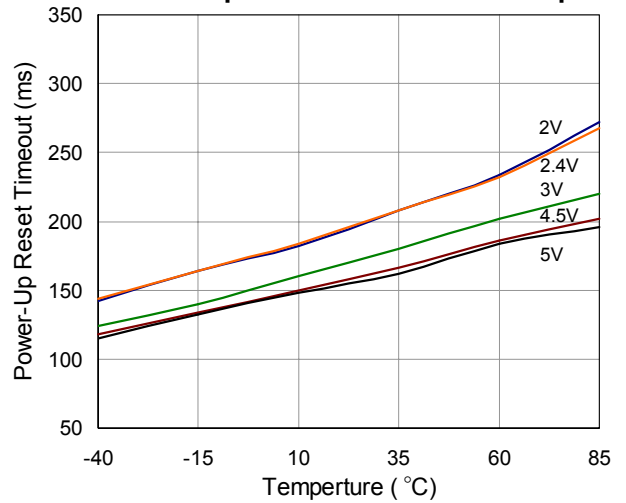

Power-Down Reset Delay vs. Temp.

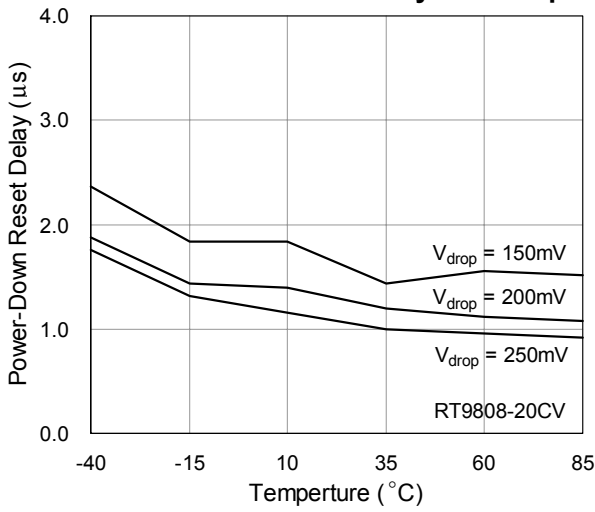

Power-Down Reset Delay vs. Temp.

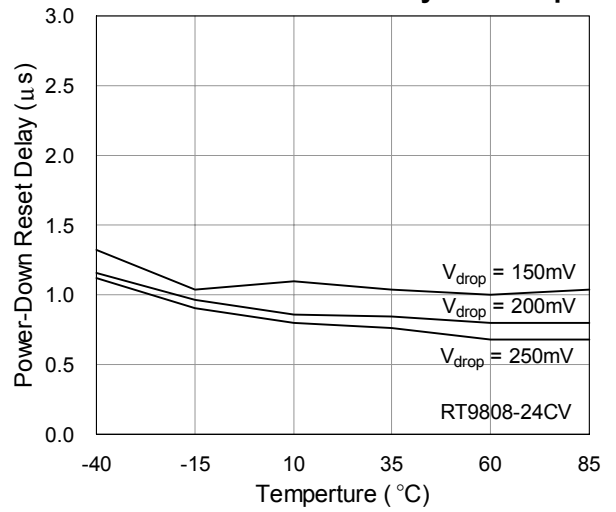

Power-Down Reset Delay vs. Temp.

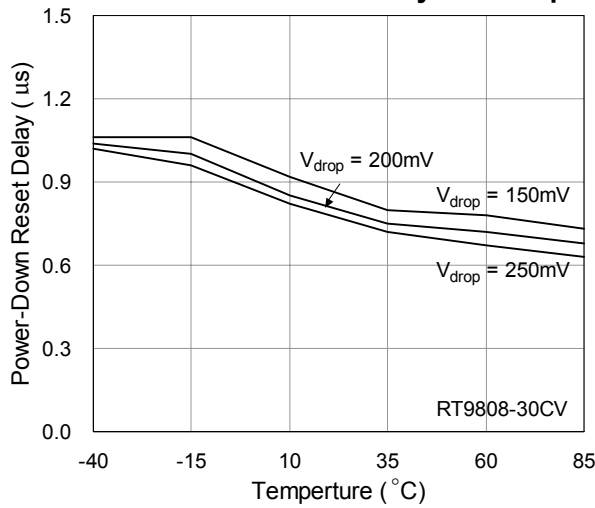

Power-Down Reset Delay vs. Temp.

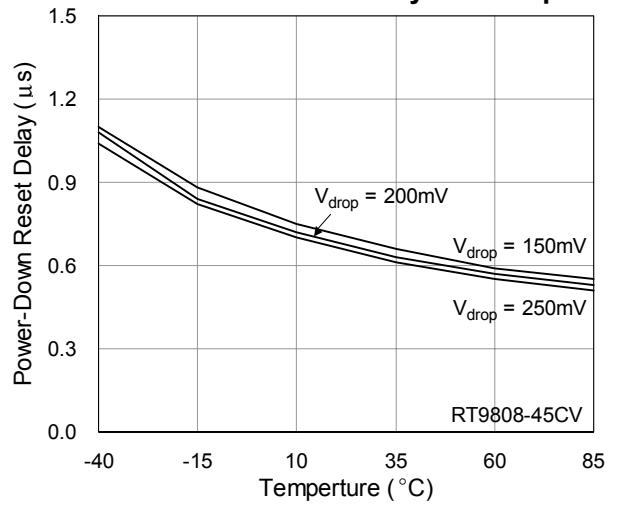

Power-Down Reset Delay vs. Temp.

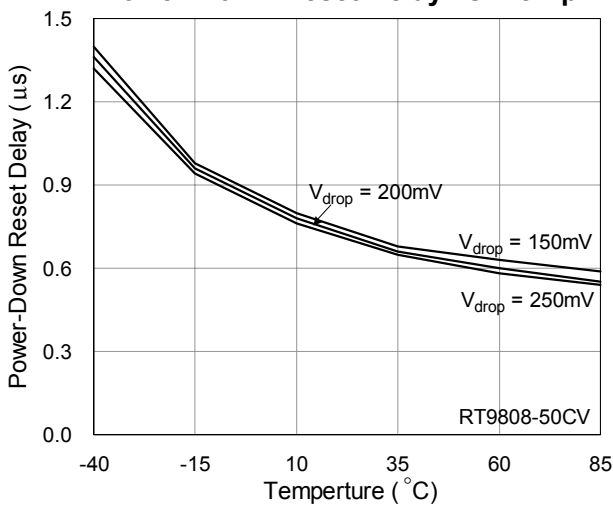

Output Delay Time vs. Load Capacitance

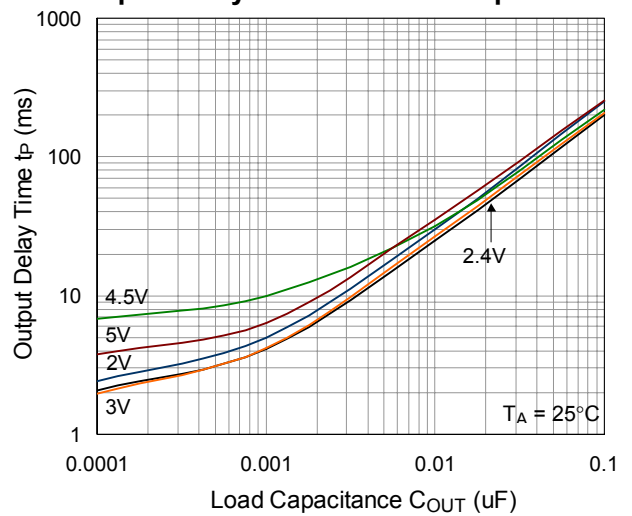

Package Information

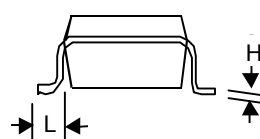
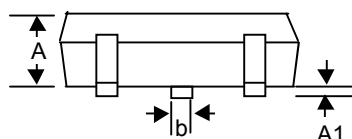
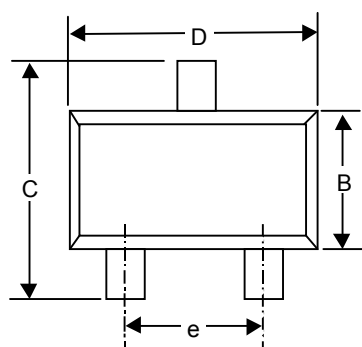

Symbol	Dimensions In Millimeters		Dimensions In Inches	
	Min	Max	Min	Max
A	0.889	1.295	0.035	0.051
A1	--	0.152	--	0.006
B	1.397	1.803	0.055	0.071
b	0.356	0.508	0.014	0.020
C	2.591	2.997	0.102	0.118
D	2.692	3.099	0.106	0.122
e	1.803	2.007	0.071	0.079
H	0.102	0.254	0.004	0.010
L	0.356	0.610	0.014	0.024

SOT-23 Plastic Surface Mount

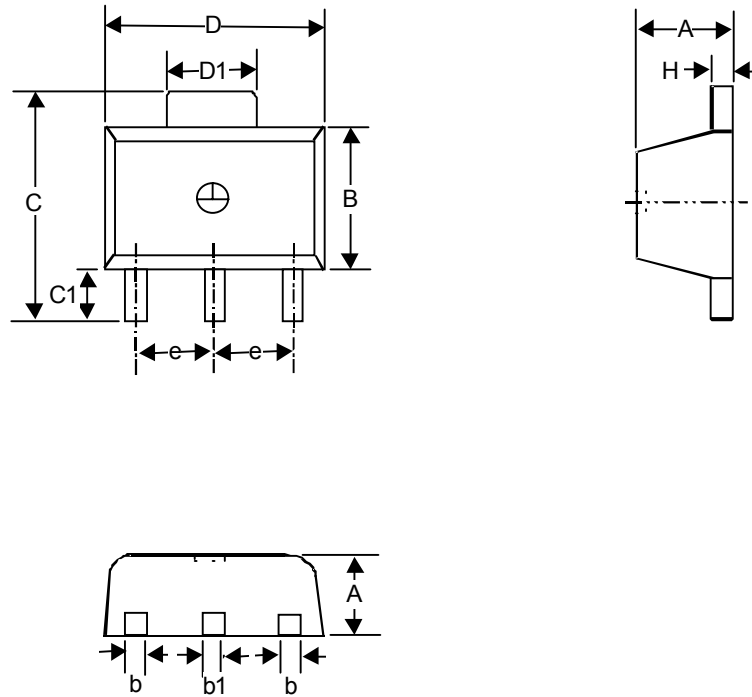

Symbol	Dimensions In Millimeters		Dimensions In Inches	
	Min	Max	Min	Max
A	1.397	1.600	0.055	0.063
b	0.356	0.483	0.014	0.019
B	2.388	2.591	0.094	0.102
b1	0.406	0.533	0.016	0.021
C	--	4.242	--	0.167
C1	0.787	1.194	0.031	0.047
D	4.394	4.597	0.173	0.181
D1	1.397	1.753	0.055	0.069
e	1.448	1.549	0.057	0.061
H	0.381	0.432	0.015	0.017

3-Lead SOT-89 Surface Mount

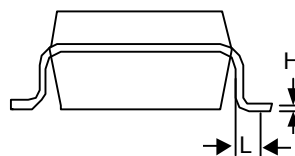
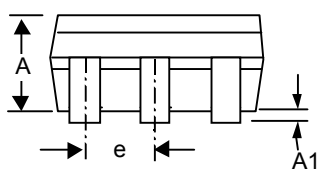
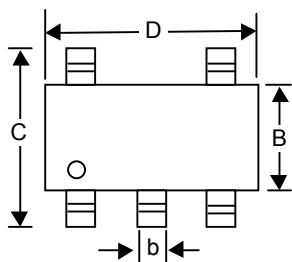

Symbol	Dimensions In Millimeters		Dimensions In Inches	
	Min	Max	Min	Max
A	0.889	1.295	0.035	0.051
A1	0.000	0.152	0.000	0.006
B	1.397	1.803	0.055	0.071
b	0.356	0.559	0.014	0.022
C	2.591	2.997	0.102	0.118
D	2.692	3.099	0.106	0.122
e	0.838	1.041	0.033	0.041
H	0.102	0.254	0.004	0.010
L	0.356	0.610	0.014	0.024

SOT- 25 Surface Mount Package

RICHTEK TECHNOLOGY CORP.

Headquarter

6F, No. 35, Hsintai Road, Chupei City

Hsinchu, Taiwan, R.O.C.

Tel: (8863)5510047 Fax: (8863)5537749

RICHTEK TECHNOLOGY CORP.

Taipei Office (Marketing)

8F-1, No. 137, Lane 235, Paochiao Road, Hsintien City

Taipei County, Taiwan, R.O.C.

Tel: (8862)89191466 Fax: (8862)89191465

Email: marketing@richtek-ic.com.tw