

SILICON GATE CMOS

32,768 WORD x 8 BIT STATIC RAM

Description

The TC55257BPL is a 262,144 bit CMOS static random access memory organized as 32,768 words by 8 bits and operated from a single 5V power supply. Advanced circuit techniques provide both high speed and low power features with an operating current of 5mA/MHz (typ.) and a minimum cycle time of 85ns.

When \overline{CE} is a logical high, the device is placed in a low power standby mode in which the standby current is 100 μ A. The TC55257BPL has two control inputs. Chip enable (\overline{CE}) allows for device selection and data retention control, while an output enable input (\overline{OE}) provides fast memory access. The TC55257BPL is suitable for use in microprocessor systems where high speed, low power, and battery backup are required.

The TC55257BPL is offered in a standard dual-in-line 28-pin plastic package (0.6/0.3 inch width), a small outline plastic package, and a thin small outline plastic package (forward type, reverse type).

Features

- Low power dissipation: 27.5mW/MHz (typ.)
- Standby current: 100 μ A (max.)
- Single 5V power supply
- Access time (max.)

	TC55257BPL/BFL/BSPL/BFTL/BTRL	
	-85	-10
Access Time	85ns	100ns
Chip Enable Access Time	85ns	100ns
Output Enable Time	45ns	50ns

- Power down feature: \overline{CE}
- Data retention supply voltage: 2.0 ~ 5.5V
- Inputs and outputs TTL compatible
- Package
 - TC55257BPL : DIP28-P-600
 - TC55257BFL : SOP28-P-450
 - TC55257BSPL : DIP28-P-300B
 - TC55257BFTL : TSOP28-P
 - TC55257BTRL : TSOP28-P-A

Pin Names

A0 ~ A14	Address Inputs
R/W	Read/Write Control Input
\overline{OE}	Output Enable Input
\overline{CE}	Chip Enable Input
I/O1 ~ I/O8	Data Input/Output
V _{DD}	Power (+5V)
GND	Ground

PIN NO.	1	2	3	4	5	6	7	8	9	10	11	12	13	14
PIN NAME	\overline{OE}	A ₁₁	A ₉	A ₈	A ₁₃	R/W	V _{DD}	A ₁₄	A ₁₂	A ₇	A ₆	A ₅	A ₄	A ₃
PIN NO.	15	16	17	18	19	20	21	22	23	24	25	26	27	28
PIN NAME	A ₂	A ₁	A ₀	I/O1	I/O2	I/O3	GND	I/O4	I/O5	I/O6	I/O7	I/O8	\overline{CE}	A ₁₀

Pin Connection (Top View)

○ 28 PIN DIP & SOP ○ 28 PIN TSOP

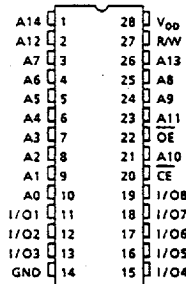

(forward type)

(reverse type)

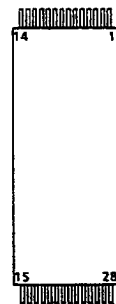

Block Diagram

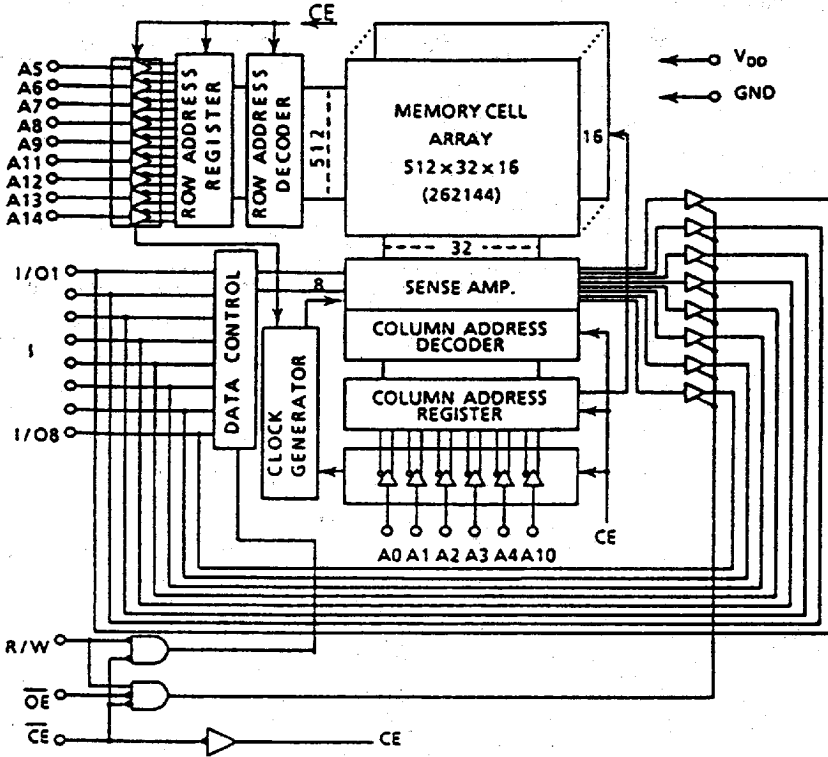

Operating Mode

MODE	PIN	\overline{CE}	\overline{OE}	R/W	I/O1 - I/O8	POWER
Read		L	L	H	D _{OUT}	I _{DDO}
Write		L	*	L	D _{IN}	I _{DDO}
Output Deselect		L	H	H	High-Z	I _{DDO}
Standby		H	*	*	High-Z	I _{DDS}

* H or L

Maximum Ratings

SYMBOL	ITEM	RATING	UNIT
V _{DD}	Power Supply Voltage	-0.3 ~ 7.0	V
V _{IN}	Input Voltage	-0.3* ~ 7.0	V
V _{YO}	Input and Output Voltage	-0.5* ~ V _{DD} + 0.5	V
P _D	Power Dissipation	1.0/0.8/0.6**	W
T _{SOLDER}	Soldering Temperature • Time	260 • 10	°C • sec
T _{STRG}	Storage Temperature	-55 ~ 150	°C
T _{OPR}	Operating Temperature	0 ~ 70	°C

* -3.0V with a pulse width of 50ns

** Package dependent: 0.6 inch 1.0W, 0.3 inch 0.8W, 0.45 inch 0.6W

A-2

TOSHIBA AMERICA ELECTRONIC COMPONENTS, INC.

9097248 0026157 697

DC Recommended Operating Conditions

SYMBOL	PARAMETER	MIN.	TYP.	MAX.	UNIT
V _{DD}	Power Supply Voltage	4.5	5.0	5.5	V
V _{IH}	Input High Voltage	2.2	—	V _{DD} + 0.3	
V _{IL}	Input Low Voltage	-0.3*	—	0.8	
V _{DH}	Data Retention Supply Voltage	2.0	—	5.5	

* -3.0V with a pulse width of 50ns

DC Characteristics (Ta = 0 ~ 70°C, V_{DD} = 5V±10%)

SYMBOL	PARAMETER	TEST CONDITION	MIN.	TYP.	MAX.	UNIT	
I _{LI}	Input Leakage Current	V _{IN} = 0 ~ V _{DD}	—	—	±1.0	μA	
I _{LO}	Output Leakage Current	CE = V _{IH} or R/W = V _{IL} or OE = V _{IH} V _{OUT} = 0 ~ V _{DD}	—	—	±1.0	μA	
I _{OH}	Output High Current	V _{OH} = 2.4V	-1.0	—	—	mA	
I _{OL}	Output Low Current	V _{OL} = 0.4V	4.0	—	—	mA	
I _{DDO1}	Operating Current	CE = V _{IL} R/W = V _{IH} Other Input = V _{IH} /V _{IL} I _{OUT} = 0mA	t _{cycle} = 1μs	—	10	—	mA
I _{DDO2}		CE = 0.2V R/W = V _{DD} - 0.2V Other Input = V _{DD} - 0.2V/0.2V I _{OUT} = 0mA	t _{cycle} = 1μs	—	5	—	
I _{DDO1}	Standby Current	CE = V _{IH}	—	—	3	—	mA
I _{DDO2}		CE = V _{DD} - 0.2V V _{DD} = 2.0V ~ 5.5V	Ta = 0 ~ 70°C	—	—	100	—
I _{DDO2}			Ta = 25°C	—	2	—	

Capacitance* (Ta = 25°C, f = 1MHz)

SYMBOL	PARAMETER	TEST CONDITION	MAX.	UNIT
C _{IN}	Input Capacitance	V _{IN} = GND	10	pF
C _{OUT}	Output Capacitance	V _{OUT} = GND	10	

*This parameter is periodically sampled and is not 100% tested.

AC Characteristics ($T_a = 0 \sim 70^\circ\text{C}$, $V_{DD} = 5V \pm 10\%$)

Read Cycle

SYMBOL	PARAMETER	TC55257BPL/BFL/BSPL/BFTL/BTRL				UNIT
		-85		-10		
		MIN.	MAX.	MIN.	MAX.	
t_{RC}	Read Cycle Time	85	—	100	—	ns
t_{ACC}	Address Access Time	—	85	—	100	
t_{CO}	\overline{CE} Access Time	—	85	—	100	
t_{OE}	Output Enable to Output in Valid	—	45	—	50	
t_{COE}	Chip Enable (\overline{CE}) to Output in Low-Z	10	—	10	—	
t_{OEE}	Output Enable to Output in Low-Z	5	—	5	—	
t_{OD}	Chip Enable (\overline{CE}) to Output in High-Z	—	30	—	50	
t_{ODO}	Output Enable to Output in High-Z	—	30	—	40	
t_{OH}	Output Data Hold Time	10	—	10	—	

Write Cycle

SYMBOL	PARAMETER	TC55257BPL/BFL/BSPL/BFTL/BTRL				UNIT
		-85		-10		
		MIN.	MAX.	MIN.	MAX.	
t_{WC}	Write Cycle Time	85	—	100	—	ns
t_{WP}	Write Pulse Width	60	—	70	—	
t_{CW}	Chip Selection to End of Write	65	—	90	—	
t_{AS}	Address Setup Time	0	—	0	—	
t_{WR}	Write Recovery Time	5	—	5	—	
t_{ODW}	R/W to Output in High-Z	—	30	—	50	
t_{OEW}	R/W to Output in Low-Z	5	—	5	—	
t_{DS}	Data Setup Time	40	—	40	—	
t_{DH}	Data Hold Time	0	—	0	—	

AC Test Conditions

Input Pulse Levels	2.4V/0.6V
Input Pulse Rise and Fall Time	5ns
Input Timing Measurement Reference Levels	2.2V/0.8V
Output Timing Measurement Reference Levels	2.2V/0.8V
Output Load	1 TTL Gate and $C_L = 100\text{pF}$

Timing Waveforms

Read Cycle ⁽¹⁾

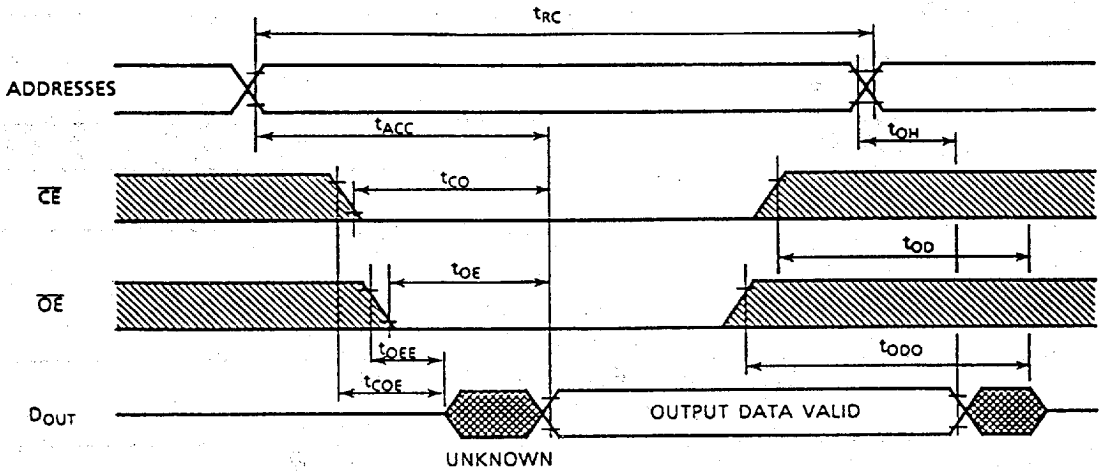

Write Cycle 1 ⁽⁴⁾ (R/W Controlled Write)

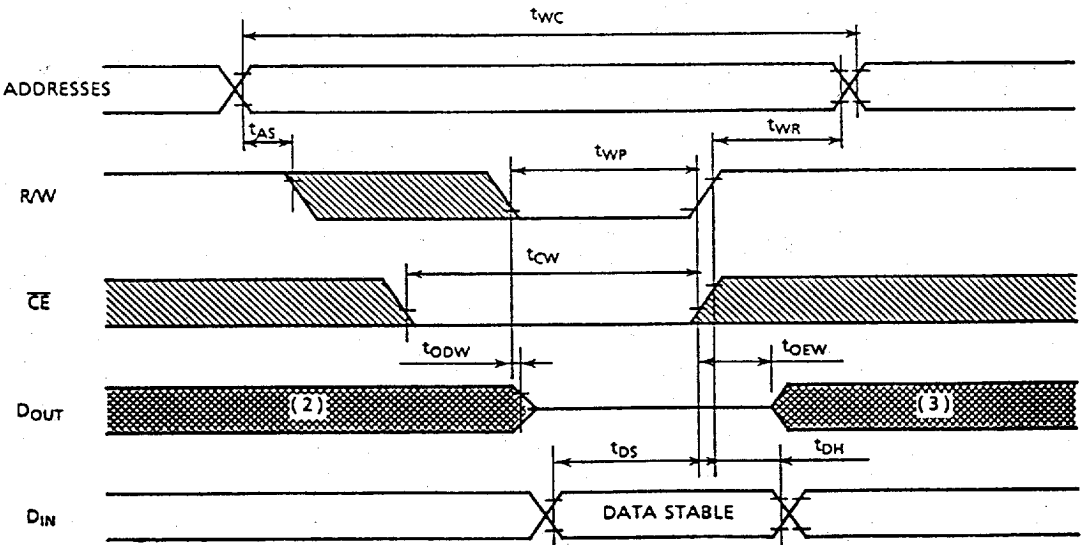

Write Cycle 2 ⁽⁴⁾ (\overline{CE} Controlled Write)

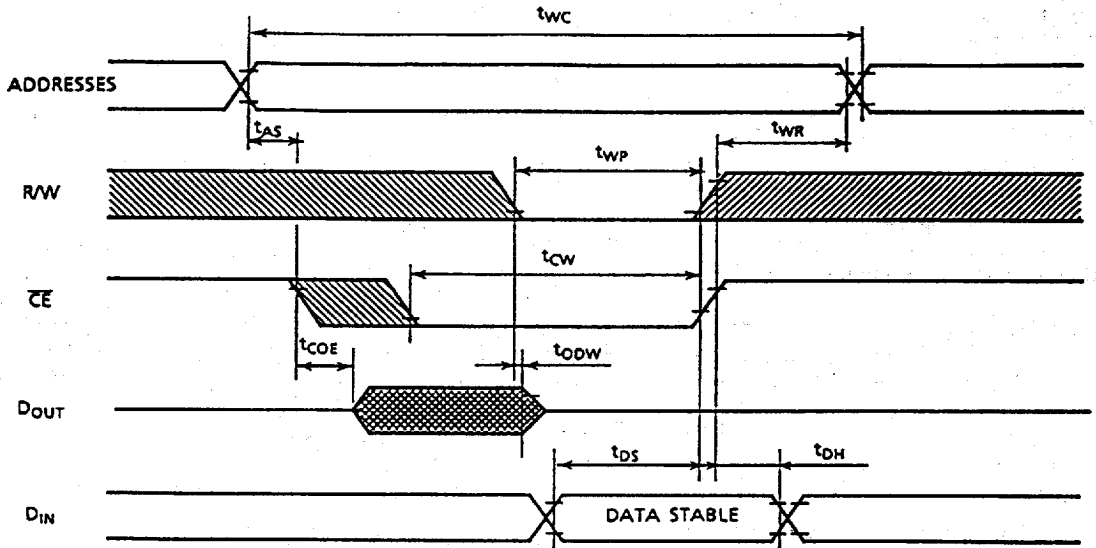

Notes:

1. R/W is high for read cycles.
2. If the \overline{CE} low transition occurs coincident with or after the R/W low transition, outputs remain in a high impedance state.
3. If the \overline{CE} high transition occurs coincident with or prior to the R/W high transition, outputs remain in a high impedance state.
4. If \overline{OE} is high during a write cycle, the outputs are in a high impedance state during this period.

Data Retention Characteristics (Ta = 0 ~ 70°C)

SYMBOL	PARAMETER	MIN.	TYP.	MAX.	UNIT
V _{DH}	Data Retention Supply Voltage	2.0	—	5.5	V
I _{DD2}	Standby Current	V _{DH} = 3.0V	—	50	μA
		V _{DH} = 5.5V	—	100	
t _{CDR}	Chip Deselect to Data Retention Mode	0	—	—	μs
t _R	Recovery Time	t _{RC(1)}	—	—	

Note (1): Read Cycle Time

\overline{CE} Controlled Data Retention Mode

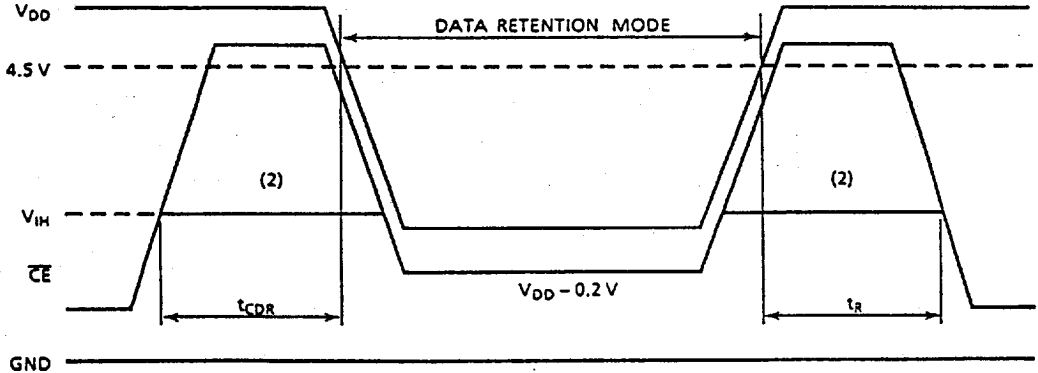

Note (2): If the V_{IH} of \overline{CE} is 2.2V in operation, I_{DD2} current flows during the period that the V_{DD} voltage is going down from 4.5V to 2.4V.