

LI-ION BATTERY PROTECTOR

DESCRIPTION

The SC451XX series are protection ICs for over-charge /discharge of rechargeable one-cell Lithium-ion (Li+) batteries by CMOS process.

The SC451XX series can detect over-charge/discharge of Li+ one-cell and excess load current, further include a short circuit protector for preventing large external short circuit current.

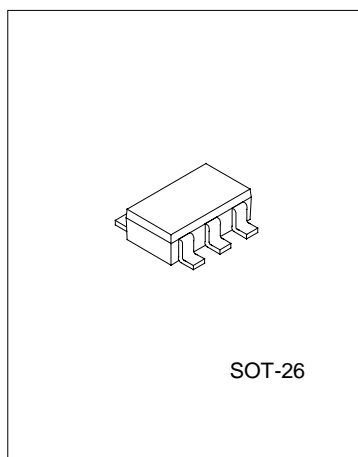

FEATURES

- * Low supply current.
- * High withstand voltage.
- * High accuracy detector threshold.
- * Variety of detector threshold.
- * Built-in protection circuit.
- * Output delay of over-charge.
- * Ultra small package: SOT-26

APPLICATIONS

- * Over-charge/over-discharge protection for Li+ one-cell pack
- * High precision protectors for cell-phones and any other gadgets using on board Li+ one-cell battery.

PIN ASSIGNMENT

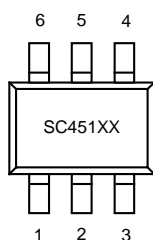

BLOCK DIAGRAM

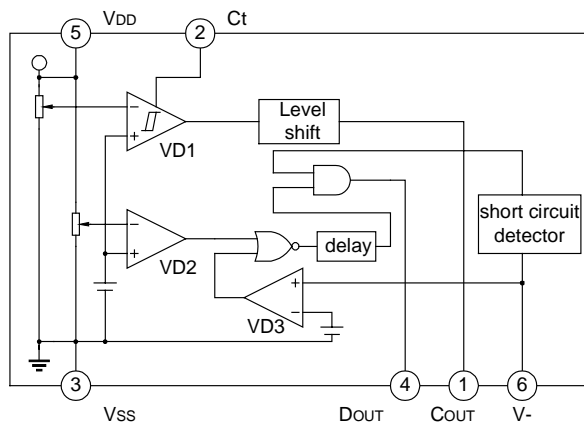

ABSOLUTE MAXIMUM RATING

Characteristic	Symbol	Value	Unit
Supply Voltage	V _{DD}	0.3 ~ 12	V
Input Voltage	V ₋	V _{DD} -18~V _{DD} +0.3	V
	V _{CT}	V _{SS} -0.3 ~ V _{DD} +0.3	V
Output Voltage	V _{COU} T	V _{DD} -18~V _{DD} +0.3	V
	V _{DOU} T	V _{SS} -0.3 ~ V _{DD} +0.3	V
Power Dissipation	P _D	150	mW
Storage Temperature	T _{STG}	-55 ~ +125	°C
Operating Temperature	T _{OPR}	-40 ~ + 85	°C

ELECTRICAL CHARACTERISTICS (T_{amb}=25°C, unless otherwise specified)

Sc451XX-01

Parameter	Symbol	Conditions	Min	Typ	Max	Unit
Operating Voltage	V _{DD1}	Voltage defined as V _{DD} -V _{SS}	1.5		10	V
Min Operating Voltage for 0V Charging	V _{st}	Voltage defined as V _{DD} -V ₋ , V _{DD} -V _{SS} =0V			1.2	V
Over-charge Threshold Voltage	V _{DET1}	Detect rising edge of supply voltage	4.20	4.25	4.30	V
Over-charge Threshold Hysteresis Range	V _{HYS1}		0.15	0.2	0.25	V
Output Delay Time of Over-charge	T _{VDET1}	C3=0.01μF, V _{DD} =3.6V→4.3V	50	75	100	ms
Over-discharge Threshold Voltage	V _{DET2}	Detect falling edge of supply voltage	2.437	2.500	2.563	V
Output Delay Time of Over-Discharge	T _{VDET2}	V _{DD} =3.6V→2.4V	7	10	13	ms
Excess Current Threshold Voltage	V _{DET3}	Detect rising edge of "V-" pin voltage	0.17	0.20	0.23	V
Output Delay Time of Excess Current	T _{VDET3}	V _{DD} =3.0V	9	13	17	ms
Short Detection Voltage	V _{short}	V _{DD} =3.0V	V _{DD} -1.1	V _{DD} -0.8	V _{DD} -0.5	V
Output Delay Time of Short Detection	T _{short}	V _{DD} =3.0V		5	50	μs
Reset Resistance for Excess Current Protection	R _{short}	V _{DD} =3.6V, V ₋ =1.0	50	100	150	kΩ
Nch ON Voltage of COUT	V _{OL1}	I _{OL} =50μA, V _{DD} =4.4V		0.2	0.5	V
Pch ON Voltage of COUT	V _{OH1}	I _{OH} = -50μA, V _{DD} =3.9V	3.4	3.8		V
Nch ON Voltage of DOUT	V _{OL2}	I _{OL} =50μA, V _{DD} =2.4V		0.2	0.5	V
Pch ON voltage of DOUT	V _{OH2}	I _{OH} = -50μA, V _{DD} =3.9V	3.4	3.7		V
Supply Current	I _{DD}	V _{DD} =3.9V, V ₋ =0V		3.0	6.0	μA
Standby Current	I _{standby}	V _{DD} =2.0V		0.3	0.6	μA

SC451XX-02

Parameter	Symbol	Conditions	Min	Typ	Max	Unit
Operating Voltage	VDD1	Voltage defined as VDD-VSS	1.5		10	V
Min Operating Voltage for 0V Charging	Vst	Voltage defined as VDD-V-, VDD-VSS=0V			1.2	V
Over-charge Threshold Voltage	VDET1	Detect rising edge of supply voltage	4.30	4.35	4.40	V
Over-charge Threshold Hysteresis Range	VHYS1		0.15	0.2	0.25	V
Output Delay Time of Over-charge	TVDET1	C3=0.01 μ F, VDD=3.6V \rightarrow 4.3V	55	80	105	ms
Over-discharge Threshold Voltage	VDET2	Detect falling edge of supply voltage	2.437	2.500	2.563	V
Output Delay Time of Over-discharge	TVDET2	VDD=3.6V \rightarrow 2.4V	7	10	13	ms
Excess Current Threshold Voltage	VDET3	Detect rising edge of "V-" pin voltage	0.17	0.20	0.23	V
Output Delay Time of Excess Current	TVDET3	VDD=3.0V	9	13	17	ms
Short Detection Voltage	Vshort	VDD=3.0V	VDD-1.1	VDD-0.8	VDD-0.5	V
Output Delay Time of Short Detection	Tshort	VDD=3.0V		5	50	μ s
Reset Resistance for Excess Current Protection	Rshort	VDD=3.6V, V- =1.0	50	100	150	k Ω
Nch ON Voltage of COUT	VOL1	IOL=50 μ A, VDD=4.4V		0.2	0.5	V
Pch ON Voltage of COUT	VOH1	IOH= -50 μ A, VDD=3.9V	3.4	3.8		V
Nch ON Voltage of DOUT	VOL2	IOL=50 μ A, VDD=2.4V		0.2	0.5	V
Pch ON Voltage of DOUT	VOH2	IOH= -50 μ A, VDD=3.9V	3.4	3.7		V
Supply Current	IDD	VDD=3.9V, V- =0V		3.0	6.0	μ A
Standby Current	Istandby	VDD=2.0V		0.3	0.6	μ A

PIN DESCRIPTION

PIN No.	Symbol	Description
1	COUT	Output of over-charge detection, CMOS output
2	CT	Pin for external capacitor setting output delay of VD1
3	VSS	Ground
4	DOUT	Output of over-discharge detection, CMOS output
5	VDD	Power supply
6	V-	Pin for charger negative input

FUNCTIONAL DESCRIPTION**• VD1/OVER-CHARGE DETECTOR**

The VD1 monitors VDD pin voltage. When the VDD voltage crosses over-charge detector threshold VDET1 from a low value to a value higher than the VDET1, the VD1 can sense over-charging and an external charge control Nch-MOS-FET turns to “off” with COUT pin being at “L”.

An output delay time for over-charges detection can be set by an external capacitor C3 connecting the VSS pin and Ct pin. The external capacitor can make a delay time from a moment detecting over-charge to a time output a signal which enables charge control Nch-MOS-FET for turning to “off”. Though the VDD voltage would be going up to a higher level than VDET1 if it is within a time period of the output delay time, VD1 would not output a signal for turning “off” of charge control Nch-MOS-FET. The output delay time can be calculated as below:

$$t_{VDET1} = \frac{C3 \times (VDD - 0.7)}{0.48 \times 10^{-6}}$$

A level shifter incorporated in a buffer driver for the COUT pin makes the “L” of COUT pin to the V-pin voltage and the “H” of COUT pin is set to VDD voltage with CMOS buffer.

• RESET CONDITIONS FROM OVERCHARGING OF SC451XX-01

There can be two cases to reset the VD1 making the COUT pin level to “H” again after detecting over-charge. Resetting the VD1 makes the charging system ready for resumption of charging process.

The first case is in such condition that a time when the VDD voltage is coming down to a level lower than “VDET1-VHYS1”. While in the second case, disconnecting a charger from the battery pack can make the VD1 resetting when the VDD level is within hysteresis width ($V_{DET1} - V_{HYS1} \leq V_{DD} \leq V_{DET1}$).

After detecting over-charge with the VDD voltage of higher than VDET1, connecting system load to the battery pack makes load current allowable through parasitic diode of external charge control Nch-MOS-FET. The COUT level would be “H” when the VDD level is coming down to a level below the VDET1 by continuous drawing of load current.

• RESET CONDITIONS FROM OVERCHARGING OF SC451XX-02

After detecting over-charge, the VD1 would not be release and COUT level would not switch to “H” again with the exception that a cell voltage reaches to a lower value than “VDET1-VHYS1” by self discharge of cell or else. After detecting over-charge, when the VDD level stays at a value higher than “VDET1-VHYS1”, to connect battery pack to a system load makes battery pack being disable at for charging or discharging because of excess current detector operated being DOUT “L”.

• VD2/OVER-DISCHARGE DETECTOR

The VD2 monitors a VDD pin voltage. When the VDD voltage crosses the over-discharge detector threshold VDET2 from a high value to a value lower than the VDET2, the VD2 can sense an over-discharging and the external discharge control Nch-MOS-FET turns to “off” with the DOUT pin being at “L”.

Resetting the VD2 with the DOUT pin level being “H” again after detecting over-discharge is only possible by connecting a charger to the battery pack. When the VDD voltage stays under over-discharge detector threshold VDET2 charge current can flow through parasitic diode of external discharge control Nch-MOS-FET, then after the VDD voltage comes up to a value larger than VDET2 discharging process would be advanced through “on” state discharge control Nch-MOS-FET. Connecting a charger to the battery pack makes the DOUT level being “H” instantaneously when the VDD voltage is higher than VDET2.

When a cell voltage equals to zero, connecting charger to the battery pack makes the system allowable for charge with higher charge voltage than Vst, 1.2V Max.

An output delay time of the over-discharge detection is fixed internally. Though the VDD voltage would be going down to a lower level than VDET2 if it is within a time period of the output delay time, VD2 would not output a signal for turning “off” of discharge control Nch-MOS-FET.

After detection of an over-discharge by VD2, supply current would be reduced to 0.3μATYP. at VDD=2.0V and into standby, only the charger detector is operating.

The output type of DOUT pin is CMOS having “H” level of VDD and “L” level of VSS.

• VD3/EXCESS CURRENT DETECTOR, SHORT CIRCUIT PROTECTOR

*Both of the excess current detector and short circuit protector can work when both control Nch-MOS-FETs are in “on” state.

When the V-pin voltage is going up to a value between the short protection voltage Vshort and excess current threshold VDET3, the excess current detector operates and further soaring of V-pin voltage higher than Vshort makes the short circuit protector enabled. As a result the external discharge control Nch-MOS-FET turns to “off” with the DOUT pin being at “L”.

*An output delay time for the excess current detector is internally fixed, 13ms TYP. at VDD=3.0V. A quick recovery of V-pin level from a value between Vshort and VDET3 within the delay time keeps the discharge control FET staying “ON” state.

When the short circuit protector is enabled, the DOUT would be “L” and its delay time would be 5μs TYP.

*The V-pin has a built-in pull down resistor, TYP.100KΩ, connected to the VSS pin.

After an excess current or short circuit protection is detected, removing a cause of excess current or external short circuit makes an external discharge control Nch-MOS-FET to an “on” state automatically with the V-pin level being down to the VSS level through the built-in pull down resistor.

* When VDD voltage is higher than VDET2 at a time when the excess current is detected the SC451XX does not enter a standby mode, while VDD voltage is lower than VDET2 the SC451XX enters a standby mode.

After detecting short circuit the SC451XX will not enter a standby mode.

TIMING DIAGRAM

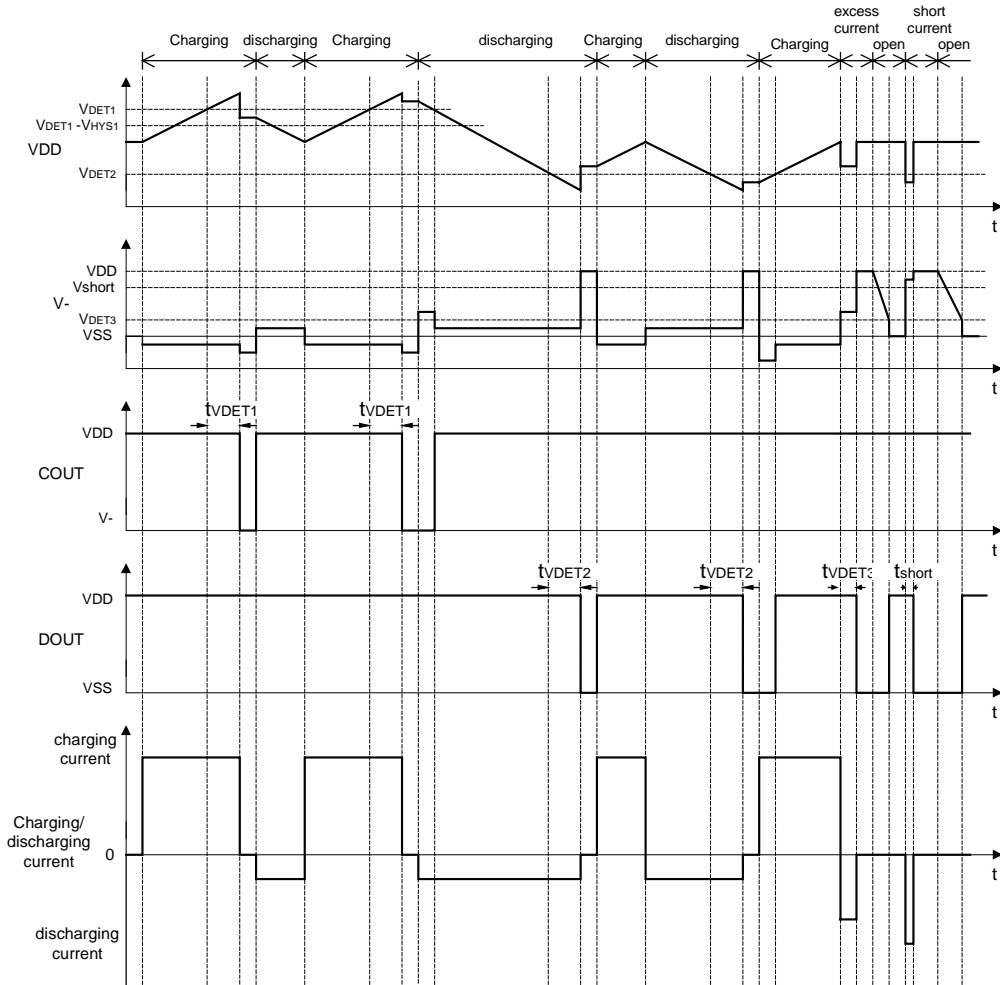

TEST CIRCUITS

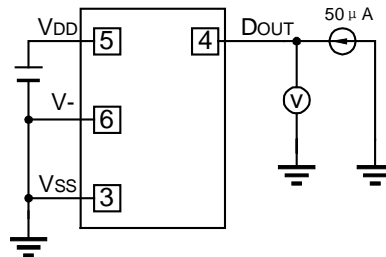
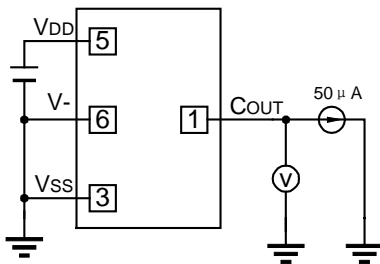
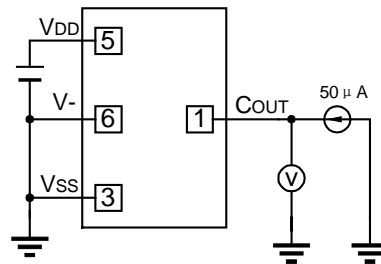
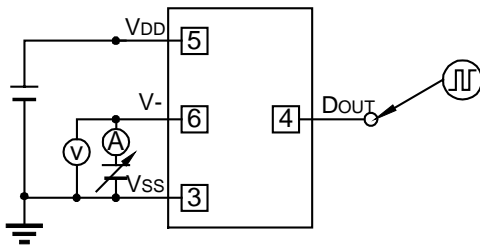
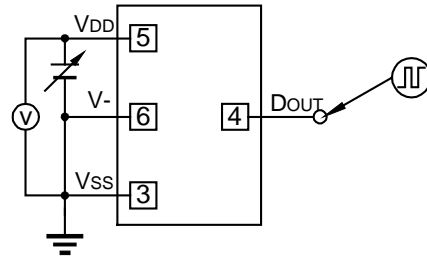
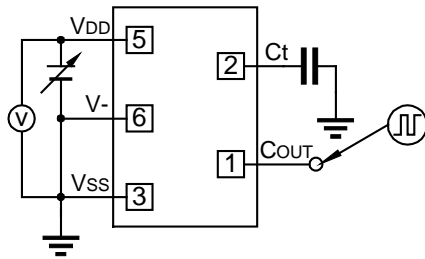

(To be continued)

(Continued)

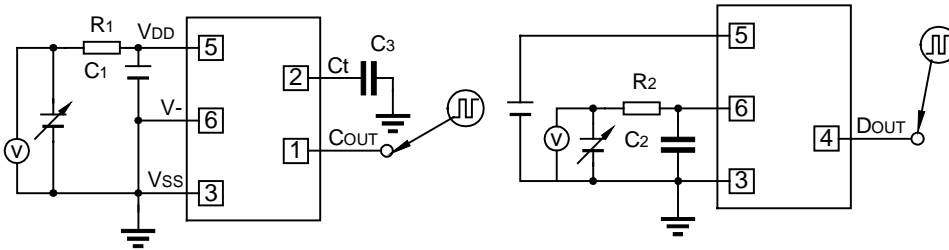
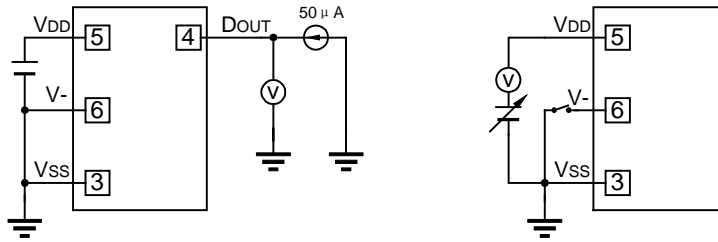

TYPICAL APPLICATION CIRCUITS

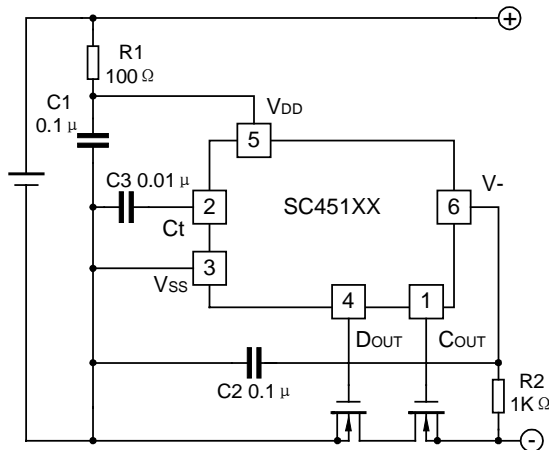

TYPICAL PERFORMANCE CHARACTERISTICS

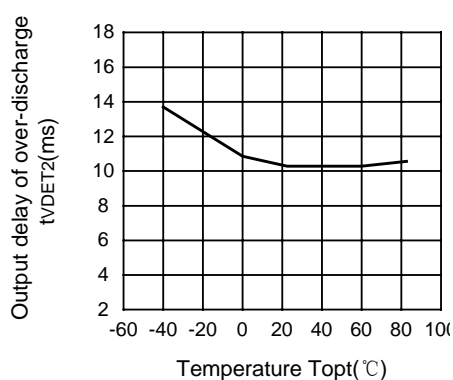
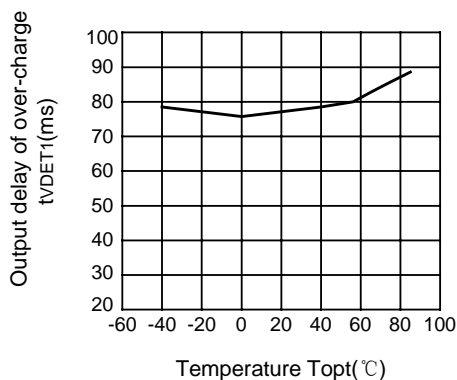
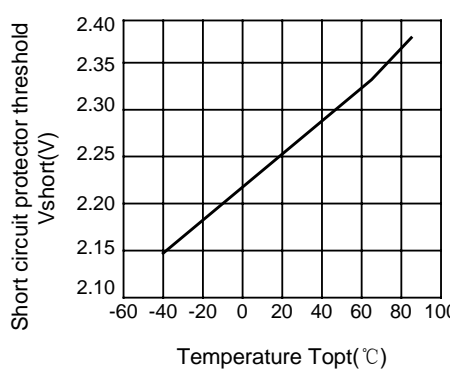
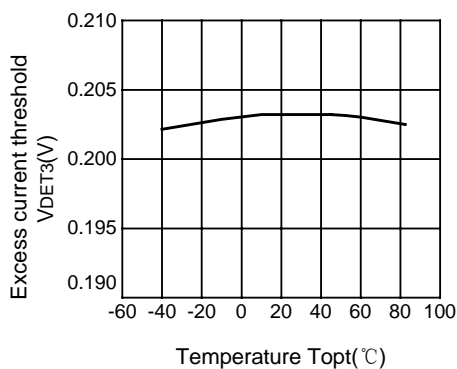
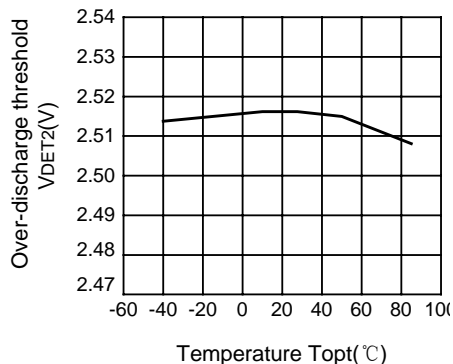
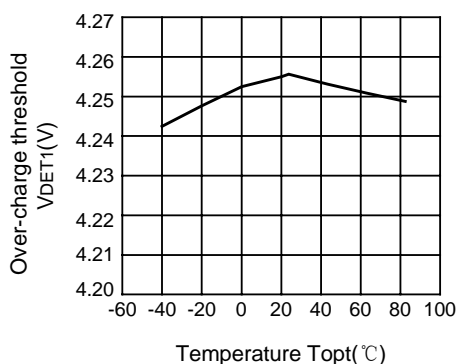

TYPICAL PERFORMANCE CHARACTERISTICS (continued)

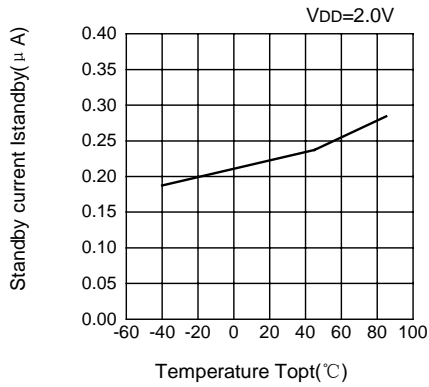
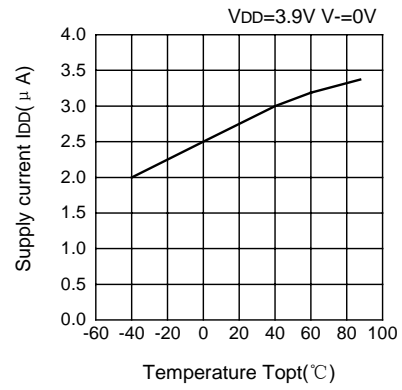
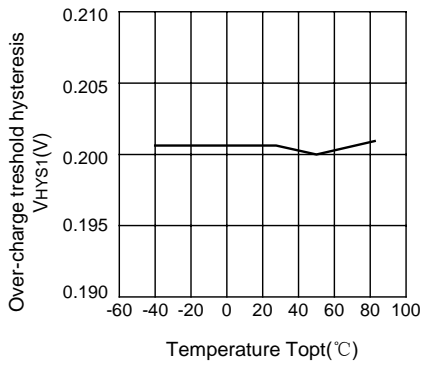
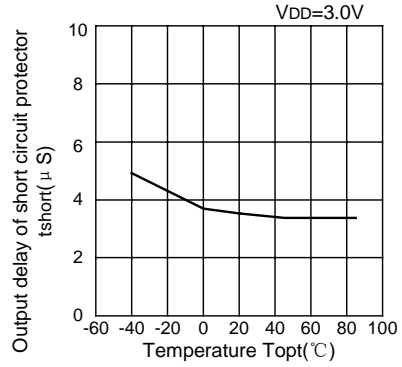
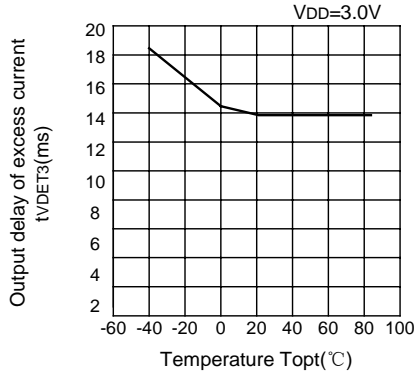

TYPICAL PERFORMANCE CHARACTERISTICS (continued)

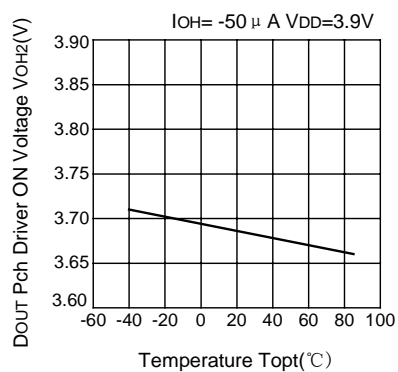
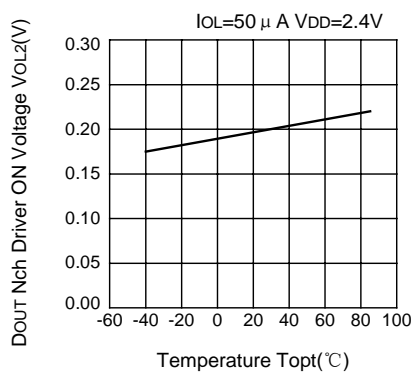
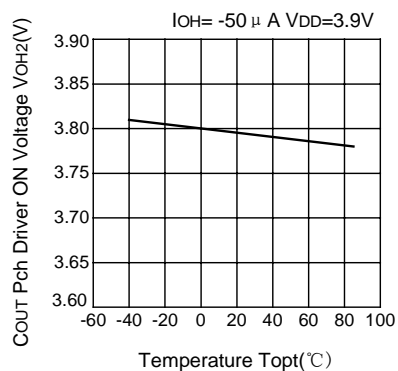
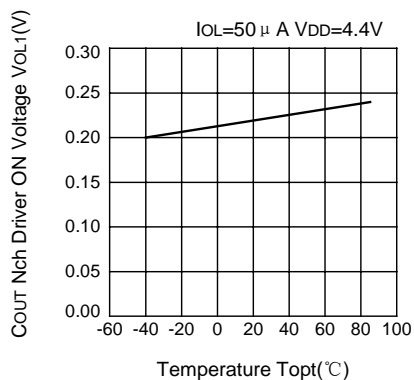

TYPICAL PERFORMANCE CHARACTERISTICS (continued)

