

NPN Silicon Transistors With High Reverse Voltage

BF 420
BF 422

- High breakdown voltage
- Low collector-emitter saturation voltage
- Low capacitance
- Complementary types: BF 421, BF 423 (PNP)

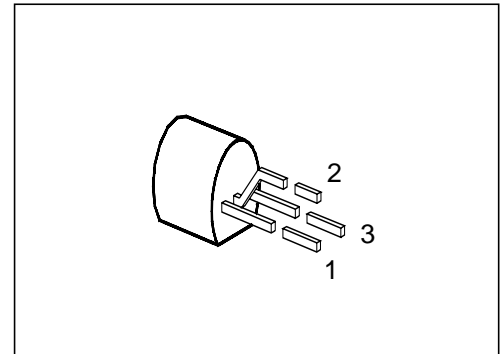

Type	Marking	Ordering Code	Pin Configuration			Package ¹⁾
			1	2	3	
BF 420 BF 422	–	Q62702-F531 Q62702-F495	E	C	B	TO-92

Maximum Ratings

Parameter	Symbol	Values		Unit
		BF 420	BF 422	
Collector-emitter voltage	V_{CE0}	–	250	V
Collector-emitter voltage $R_{BE} = 2.7 \text{ k}$	V_{CER}	300	–	
Collector-base voltage	V_{CB0}	300	250	
Emitter-base voltage	V_{EB0}	5		
Collector current	I_C	50		mA
Peak base current	I_{BM}	100		
Total power dissipation, $T_C = 88 \text{ °C}$	P_{tot}	830		mW
Junction temperature	T_j	150		
Storage temperature range	T_{stg}	– 65 ... + 150		

Thermal Resistance

Junction - ambient	$R_{th JA}$	≤ 150	K/W
Junction - case ²⁾	$R_{th JC}$	≤ 75	

¹⁾ For detailed information see chapter Package Outlines.

²⁾ Mounted on Al heat sink 15 mm × 25 mm × 0.5 mm.

Electrical Characteristics

at $T_A = 25\text{ °C}$, unless otherwise specified.

Parameter	Symbol	Values			Unit
		min.	typ.	max.	

DC characteristics

Collector-emitter breakdown voltage $I_C = 1\text{ mA}$ BF 422	$V_{(BR)CE0}$	250	–	–	V
Collector-emitter breakdown voltage $I_C = 10\text{ }\mu\text{A}$, $R_{BE} = 2.7\text{ k}$ BF 420	$V_{(BR)CER}$	300	–	–	
Collector-base breakdown voltage $I_C = 10\text{ }\mu\text{A}$ BF 420 BF 422	$V_{(BR)CB0}$	300 250	– –	– –	
Emitter-base breakdown voltage, $I_E = 10\text{ }\mu\text{A}$	$V_{(BR)EB0}$	5	–	–	
Collector cutoff current $V_{CB} = 200\text{ V}$	I_{CB0}	–	–	10	nA
Collector cutoff current $V_{CE} = 200\text{ V}$, $R_{BE} = 2.7\text{ k}$ ¹⁾ , $T_A = 150\text{ °C}$	I_{CER}	–	–	10	μA
Emitter cutoff current, $V_{EB} = 5\text{ V}$	I_{EB0}	–	–	10	
DC current gain $I_C = 100\text{ }\mu\text{A}$, $V_{CE} = 20\text{ V}$ $I_C = 25\text{ mA}$, $V_{CE} = 20\text{ V}$	h_{FE}	15 50	– –	– –	–
Collector-emitter saturation voltage ¹⁾ $I_C = 25\text{ mA}$, $T_j = 150\text{ °C}$	$V_{CEsatRF}$	–	–	20	V

AC characteristics

Transition frequency $I_C = 10\text{ mA}$, $V_{CE} = 10\text{ V}$, $f = 20\text{ MHz}$	f_t	–	100	–	MHz
Output capacitance $V_{CB} = 30\text{ V}$, $f = 1\text{ MHz}$	C_{obo}	–	0.8	–	pF

¹⁾ Pulse test: $t \leq 300\text{ }\mu\text{s}$, $D \leq 2\%$.

Total power dissipation $P_{tot} = f(T_A; T_C)$

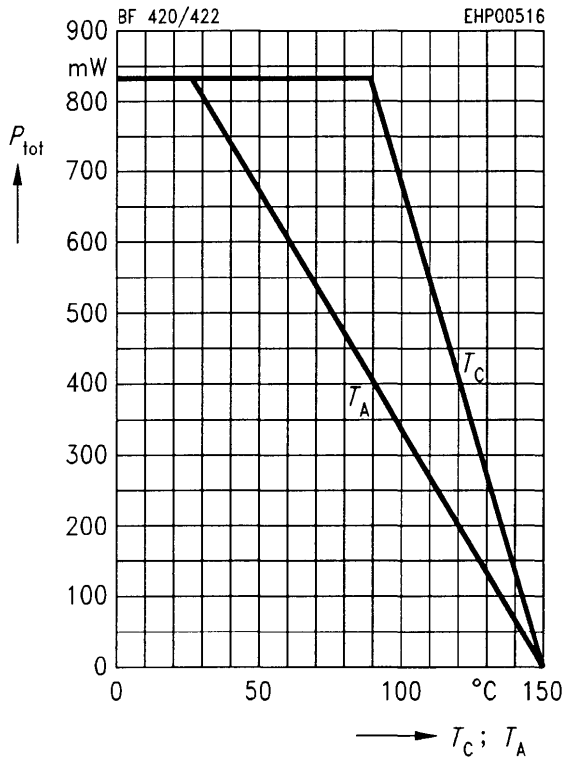

**Collector cutoff current $I_{CB0} = f(T_A)$
 $V_{CB} = 200$ V**

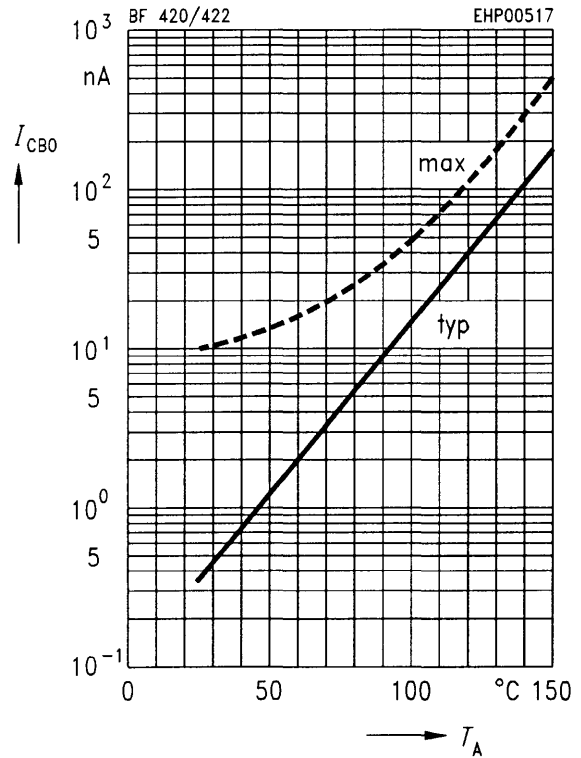

Permissible pulse load $R_{thJA} = f(t_p)$

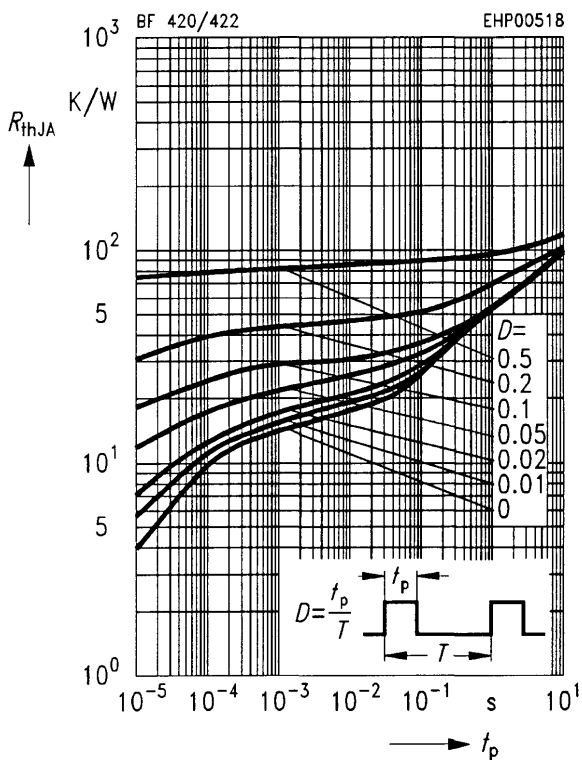

**Collector current $I_C = f(V_{BE})$
 $V_{CE} = 20$ V, $T_A = 25$ °C**

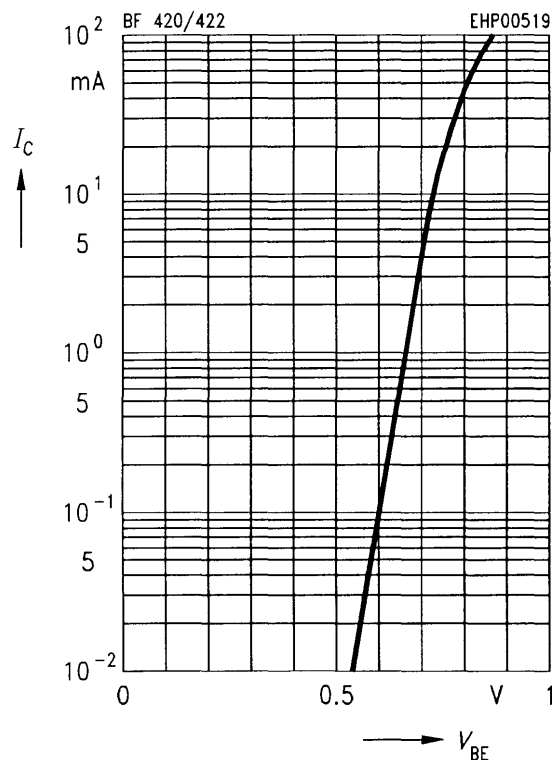

DC current gain $h_{FE} = f(I_C)$

$V_{CE} = 20 \text{ V}, T_A = 25 \text{ }^\circ\text{C}$

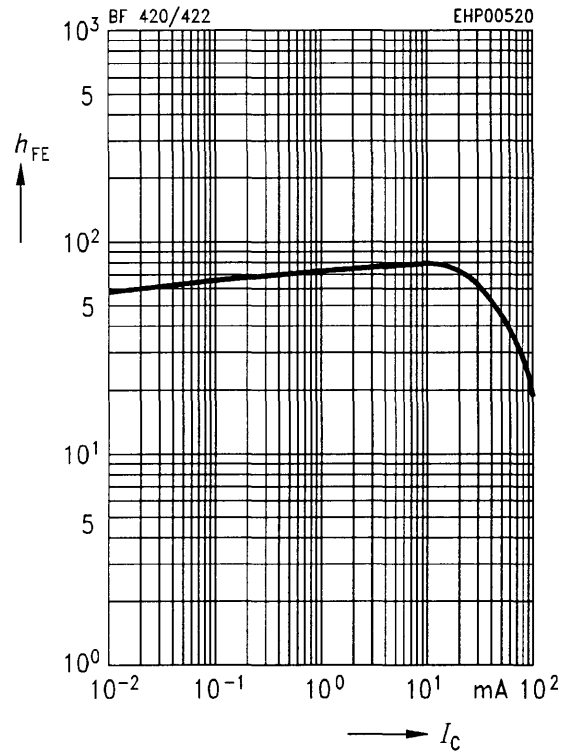

Transition frequency $f_T = f(I_C)$

$V_{CE} = 10 \text{ V}, f = 20 \text{ MHz}$

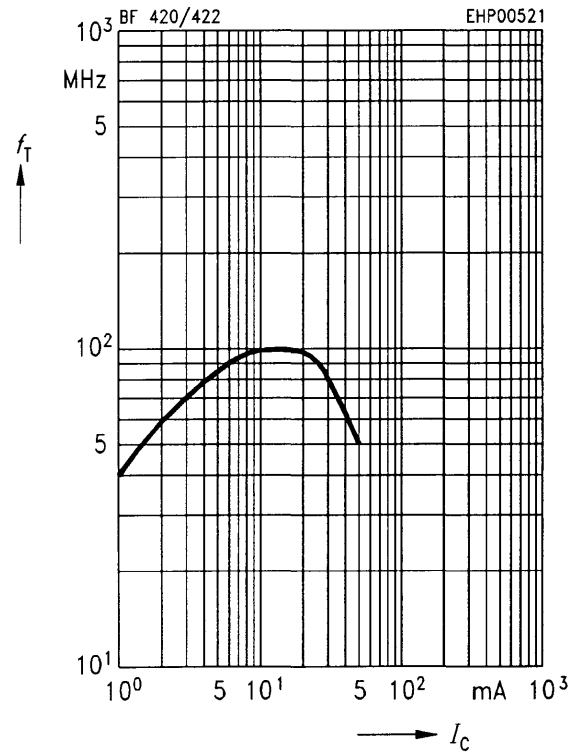

Output capacitance $C_{obo} = f(V_{CB})$

$I_C = 0, f = 1 \text{ MHz}$

