

FAN7024

675mW CMOS Mono Power Amplifier with Shutdown

Features

- Continuous Average Power is 675mW (8Ω)
- Low THD: Typical 0.3% @ $P_o=500mW$
- PSRR@217Hz, Input Terminated : 60dB
- Do Not Need Output Coupling Capacitor or Bootstrap Capacitor
- Low Shutdown Current: Typical 0.1μA
- Shutdown: High Active
- Click & Pop Suppression circuitry
- Built in TSD Circuit

Typical Applications

- Cellular Phone
- PDA
- Portable Audio Systems

Description

The FAN7024 is a bridge connected audio power amplifier capable of delivering 675mW of continuous average power to an 8Ω load with less than 0.3%(THD) from a 5V power supply. The FAN7024 requires few external components and operates on low supply voltage from 2.3V to 5.5V. Since the FAN7024 does not require output coupling capacitors, bootstrap capacitors, or snubber networks, it is ideally suited for low power portable systems that require minimum volume and weight. The FAN7024 features an externally controlled gain and low power consumption shutdown mode (0.1uA,typ.). Additional FAN7024 features include thermal shutdown protection, unity gain stability, and external gain set.

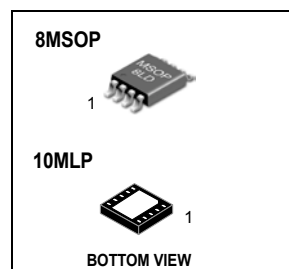

Internal Block Diagram

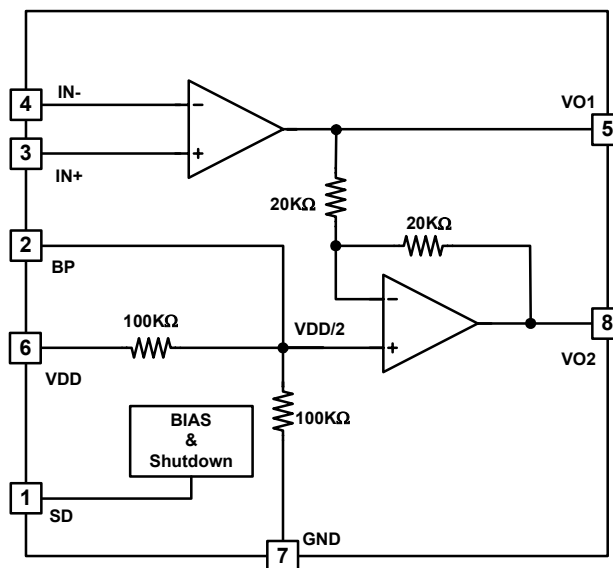

Pin Assignments

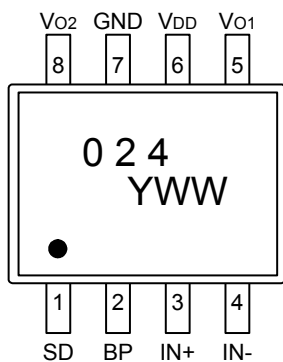

8MSOP

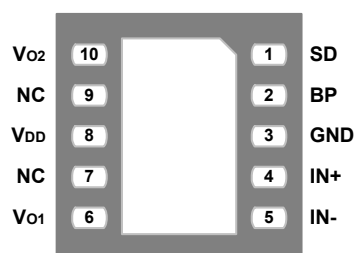

10MLP(BOTTOM VIEW)

Pin Definitions

(): 10MLP

Pin Number	Pin Name	Pin Function Description
1(1)	SD	Shutdown. Hold high to shutdown, hold low for normal operation
2(2)	BP	Bypass. Tap to voltage divider for internal mid-supply bias
3(4)	IN+	Noninverting input
4(5)	IN-	Inverting input
5(6)	VO1	Power amplifier output1
6(8)	VDD	Supply voltage input
7(3)	GND	Ground connection for circuitry
8(10)	VO2	Power amplifier output2

Absolute Maximum Ratings (Note 2)

Parameter	Symbol	Value	Unit	Remark
Maximum Supply Voltage	VDD	6.0	V	
Input Voltage	V _{IN}	-0.3 ~ VDD+0.3	V	
Power Dissipation	P _D	Internally Limited	W	
Storage Temperature	T _{STG}	-65 ~ +150	°C	
Junction Temperature	T _J	150	°C	
Thermal Resistance Junction to Ambient	R _{thja}	190	°C/W	8MSOP
		166		10MLP, Single-Layer
		50		10MLP, Multi-Layer

Recommended Operating Conditions (Note 2)

Parameter	Symbol	Min.	Typ.	Max.	Unit
Operating Supply Voltage	VDD	2.3	-	5.5	V
Operating Temperature	T _{OPR}	-40	-	85	°C

Electrical Characteristics(Note1,2)

(RL = 8Ω, Ta = 25°C, unless otherwise specified)

Parameter	Symbol	Conditions	Min.	Typ.	Max.	Unit
VDD = 5.0V , UNLESS OTHERWISE SPECIFIED						
Quiescent Power Supply Current	IDD	VIN = 0V, IO = 0A	-	2.3	5.5	mA
Shutdown Current	ISD	VSD = VDD	-	0.1	1.0	μA
Output Offset Voltage	VOS	VIN = 0V	-	0	50	mV
Output Power	PO	THD = 1%(Max.), f = 1kHz	-	675	-	mW
Total Harmonic Distortion+Noise	THD+N	PO = 500mWrms, Av=6dB, 20Hz<f<20kHz, BW<80kHz	-	0.2	-	%
Power Supply Rejection Ratio	PSRR	Vripple=200mVsinp-p				dB
		f=217Hz(Terminated input)	-	63	-	
		f=1kHz(Terminated input)	-	65	-	
		f=217Hz(Unterminated input)	-	70	-	
		f=1kHz(Unterminated input)	-	70	-	
VDD = 3.3V , UNLESS OTHERWISE SPECIFIED						
Quiescent Power Supply Current	IDD	VIN = 0V, IO = 0A	-	1.9	4	mA
Shutdown Current	ISD	VSD = VDD	-	0.1	1.0	μA
Output Offset Voltage	VOS	VIN = 0V	-	0	50	mV
Output Power	PO	THD = 1%(Max.), f = 1kHz	-	265	-	mW
Total Harmonic Distortion+Noise	THD+N	PO = 250mWrms, Av=6dB, 20Hz<f<20kHz, BW<80kHz	-	0.3	-	%
Power Supply Rejection Ratio	PSRR	Vripple=200mVsinp-p				dB
		f=217Hz(Terminated input)	-	63	-	
		f=1kHz(Terminated input)	-	65	-	
		f=217Hz(Unterminated input)	-	70	-	
		f=1kHz(Unterminated input)	-	70	-	
VDD = 2.6V , UNLESS OTHERWISE SPECIFIED						
Quiescent Power Supply Current	IDD	VIN = 0V, IO = 0A	-	1.7	3.5	mA
Shutdown Current	ISD	VSD = VDD	-	0.1	1.0	μA
Output Offset Voltage	VOS	VIN = 0V	-	0	50	mV
Output Power	PO	THD = 1%(Max.), f = 1kHz	-	130	-	mW
Total Harmonic Distortion+Noise	THD+N	PO = 100mWrms, Av=6dB, 20Hz<f<20kHz, BW<80kHz	-	0.4	-	%
Power Supply Rejection Ratio	PSRR	Vripple=200mVsinp-p				dB
		f=217Hz(Terminated input)	-	63	-	
		f=1kHz(Terminated input)	-	65	-	

Note 1 : All voltages are measured with respect to the ground pin, unless otherwise specified.

Note 2 : Absolute Maximum Ratings indicate limits beyond which damage to the device may occur. Recommended Operating Conditions indicate conditions for which the device is functional, but do not guarantee specific performance limits. Electrical Characteristics state DC and AC electrical specifications under particular test conditions which guarantee specific performance limits. This assumes that the device is within the Operating Ratings. Specifications are not guaranteed for parameters where no limit is given, however, the typical value is a good indication of device performance.

Typical Application Circuit

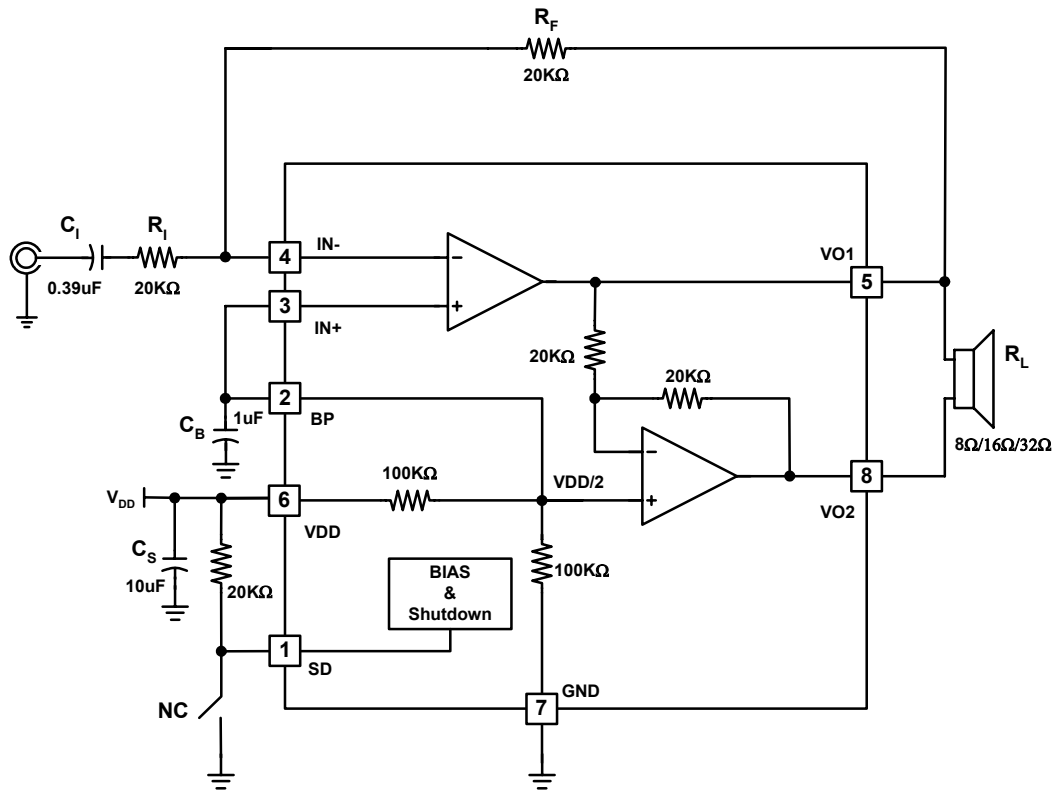

External Components Descriptions

Components	Functional Descriptions
1. R _I	The inverting input resistor which sets the closed-loop gain in conjunction with R _f . This resistor also forms a high pass filter with C _I at $f_c=1/(2\pi R_I C_I)$
2. C _I	The input coupling capacitor blocks the DC voltage at the amplifier's input terminals. Also creates a high pass with R _I at $f_c=1/(2\pi R_I C_I)$. Refer to the section, Proper Selection of External Components , for an explanation of how to determine the value of C _I .
3. R _F	The feedback resistor which sets closed-loop gain in conjunction with R _I .
4. C _S	The supply bypass capacitor which provides power supply filtering. Refer to the Application Information section for proper placement and selection of the supply bypass capacitor.
5. C _B	The bypass pin capacitor which provides half-supply filtering. Refer to the Proper Selection of External Components section for information concerning proper placement and selecting C _B 's value.

Performance Characteristics

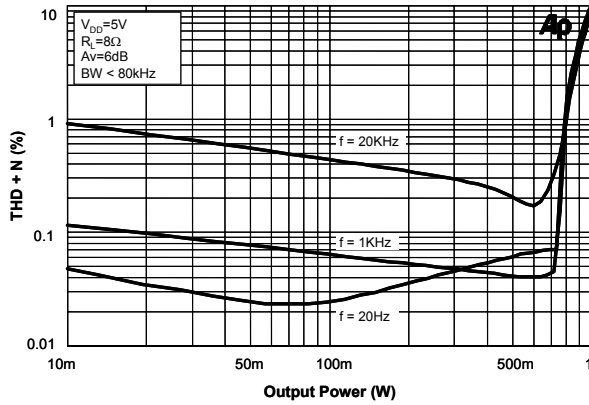

Figure 1. THD+N vs. Output Power

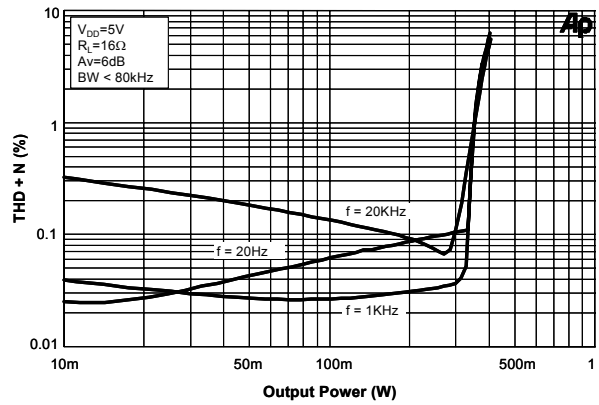

Figure 2. THD+N vs. Output Power

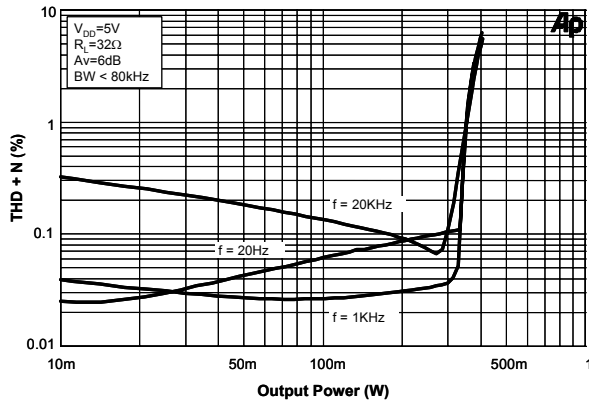

Figure 3. THD+N vs. Output Power

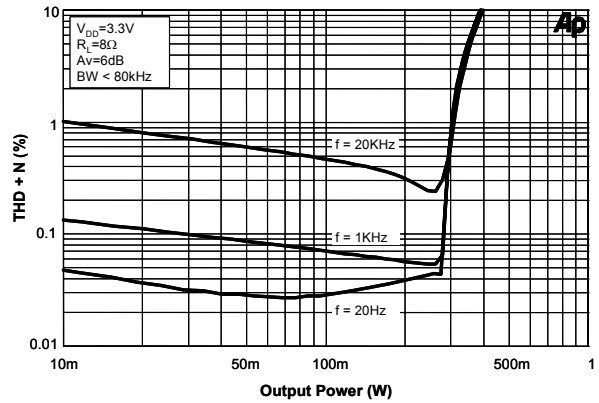

Figure 4. THD+N vs. Output Power

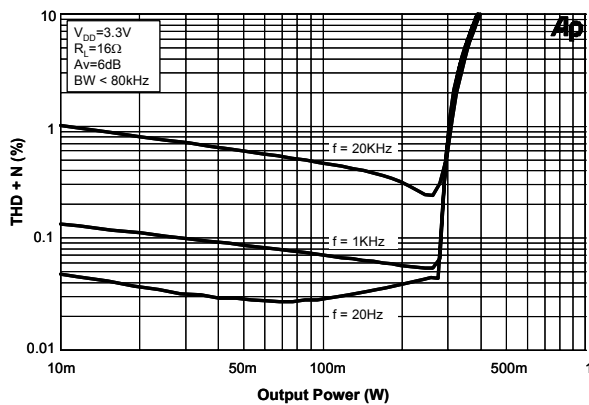

Figure 5. THD+N vs. Output Power

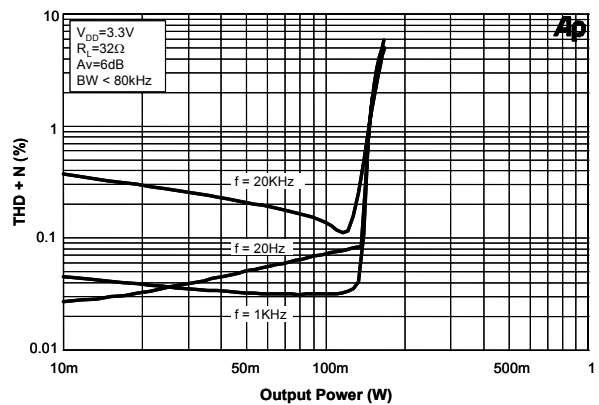

Figure 6. THD+N vs. Output Power

Performance Characteristics (Continued)

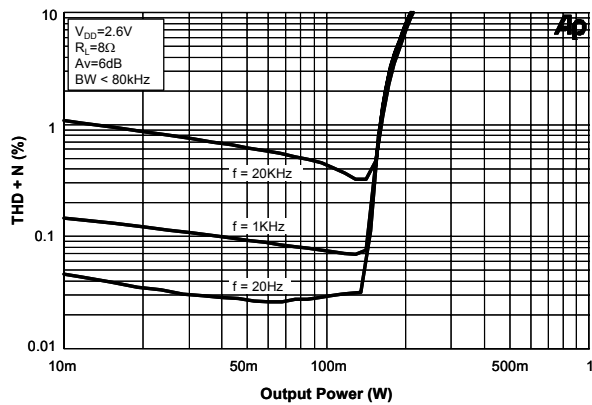

Figure 7. THD+N vs. Output Power

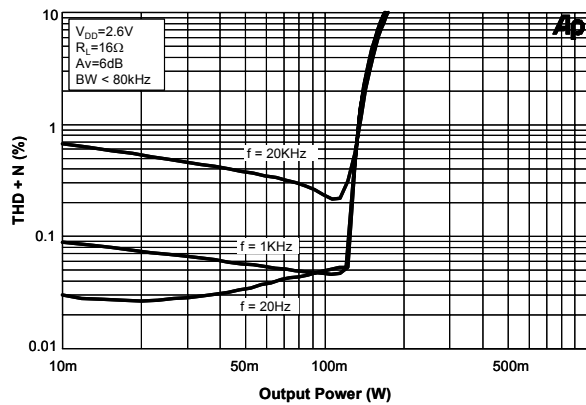

Figure 8. THD+N vs. Output Power

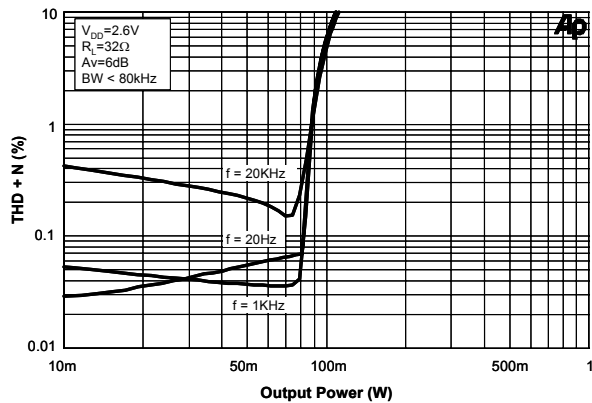

Figure 9. THD+N vs. Output Power

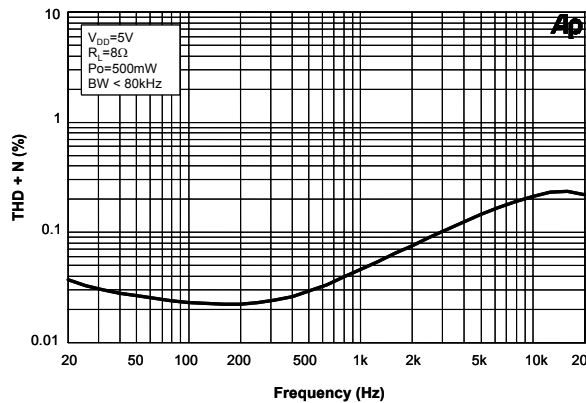

Figure 10. THD+N vs. Frequency

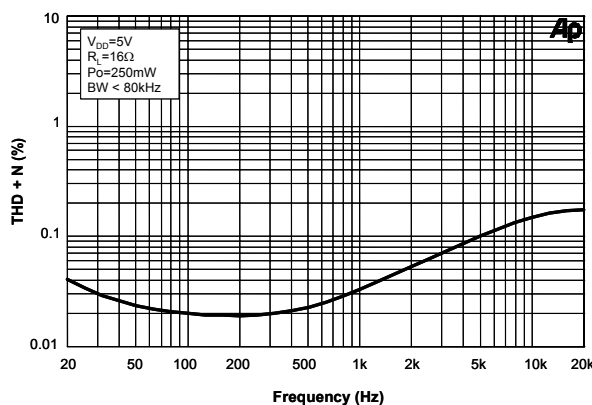

Figure 11. THD+N vs. Frequency

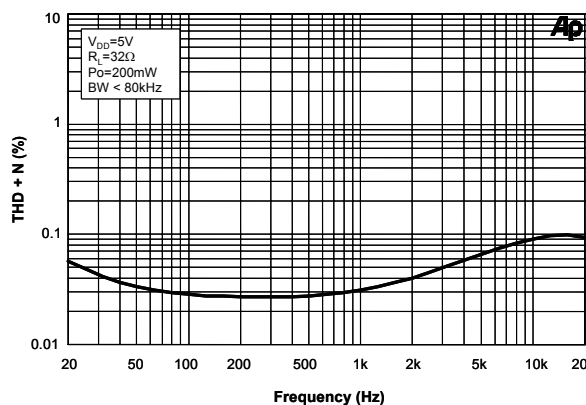

Figure 12. THD+N vs. Frequency

Performance Characteristics (Continued)

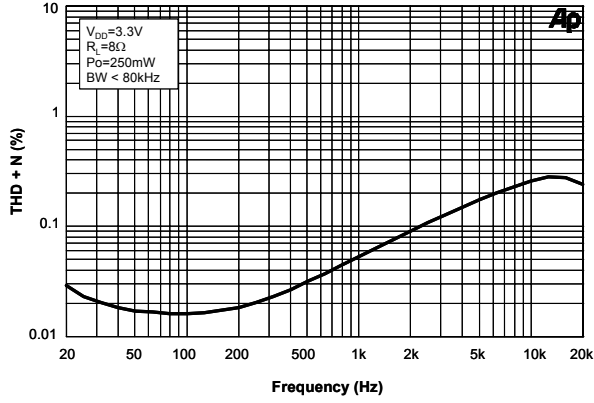

Figure 13. THD+N vs. Frequency

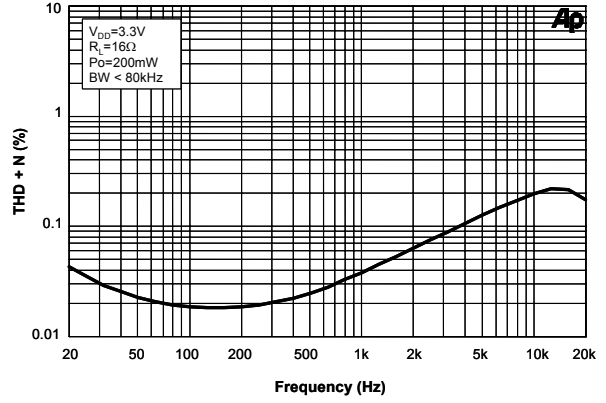

Figure 14. THD+N vs. Frequency

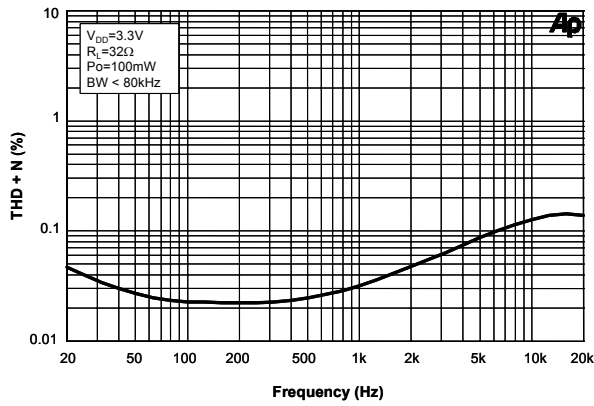

Figure 15. THD+N vs. Frequency

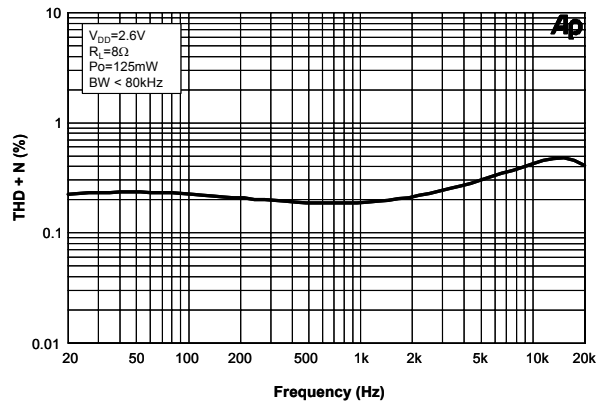

Figure 16. THD+N vs. Frequency

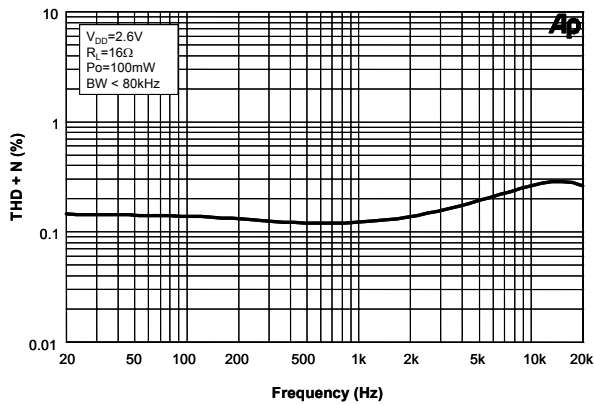

Figure 17. THD+N vs. Frequency

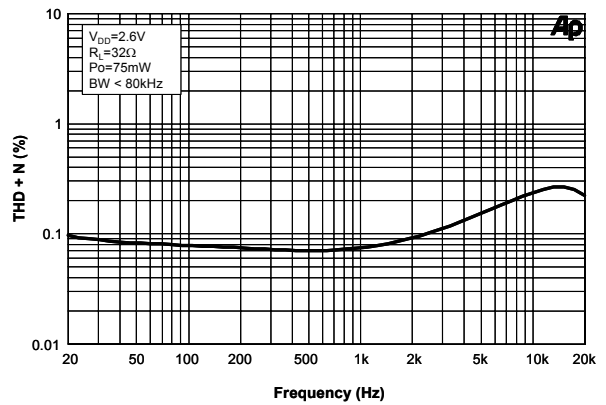

Figure 18. THD+N vs. Frequency

Performance Characteristics (Continued)

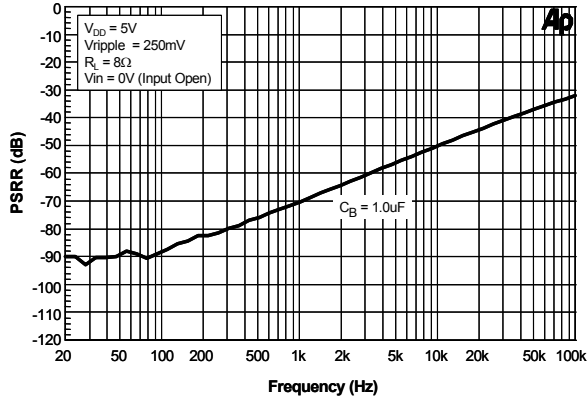

Figure 19. Power Supply Rejection Ratio

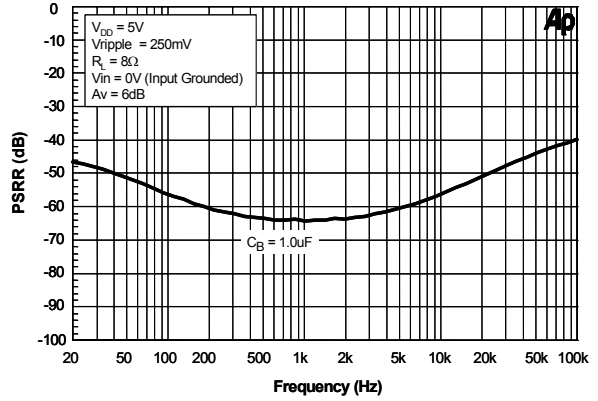

Figure 20. Power Supply Rejection Ratio

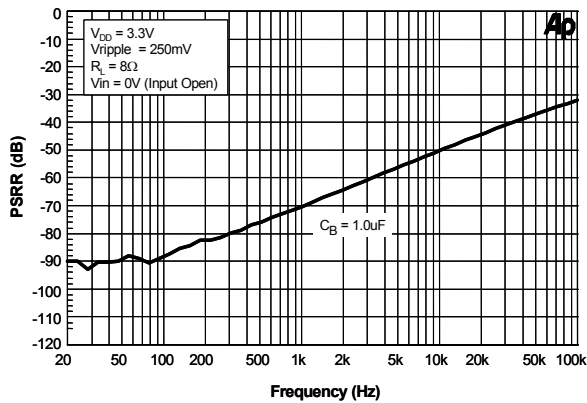

Figure 21. Power Supply Rejection Ratio

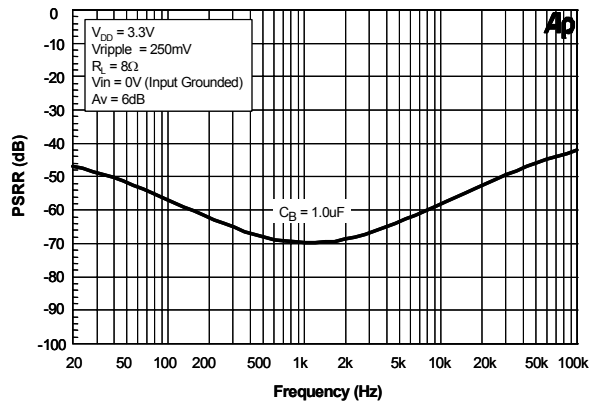

Figure 22. Power Supply Rejection Ratio

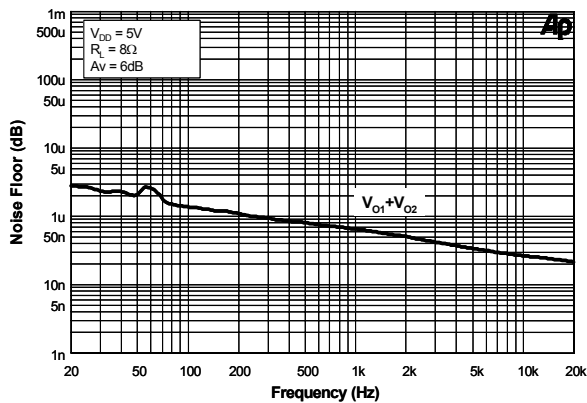

Figure 23. Noise Floor

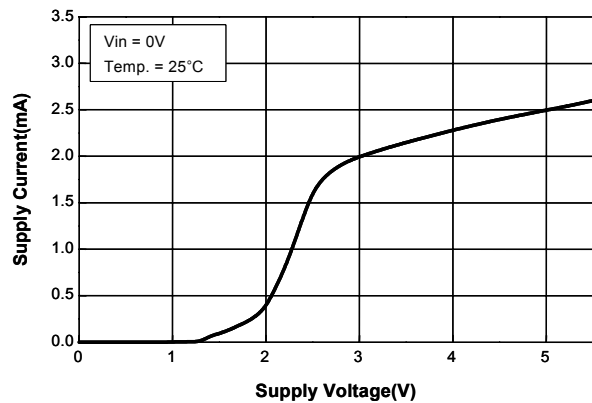

Figure 24. Supply Current vs. Supply Voltage

Performance Characteristics (Continued)

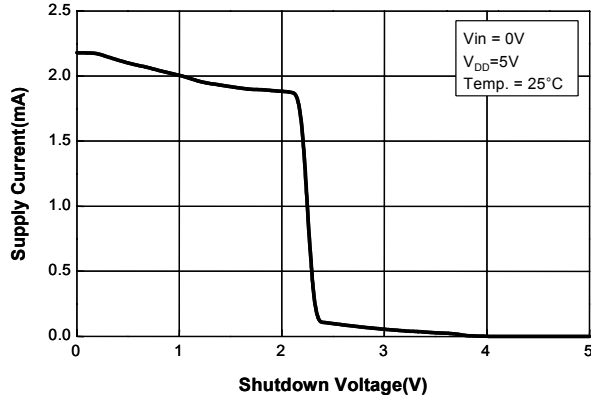

Figure 25. Supply Current vs. Shutdown Voltage

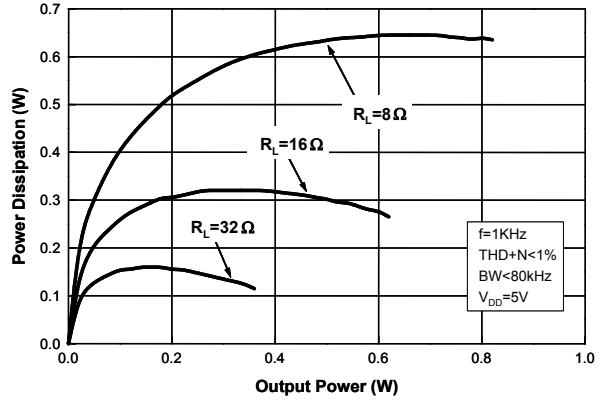

Figure 26. Power Dissipation vs. Output Power

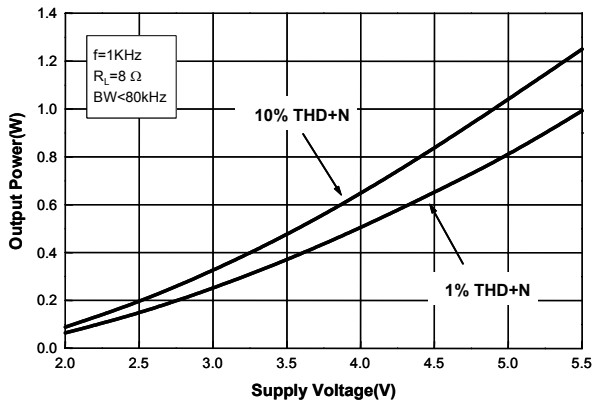

Figure 27. Output Power vs. Supply Voltage

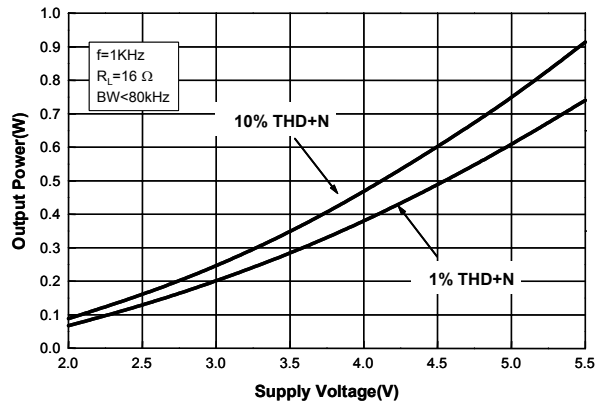

Figure 28. Output Power vs. Supply Voltage

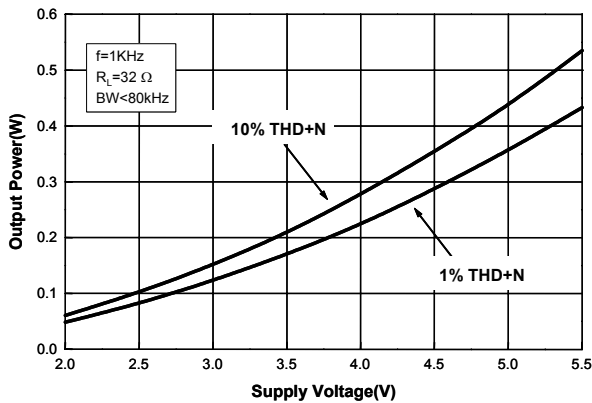

Figure 29. Output Power vs. Supply Voltage

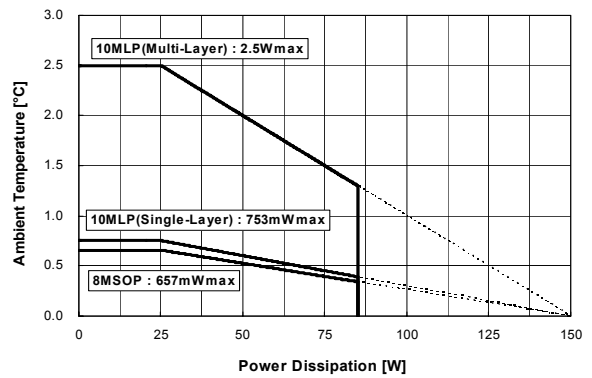

Figure 30. Power Derating Curve

Application Informations

Power Supply Bypassing

Proper power supply bypassing is critical for low noise and high power supply rejection. A larger capacitor may help to increase immunity to the supply noise. However, considering economical design, attaching 10uF electrolytic capacitor or tantalum capacitor with 0.1uF ceramic capacitor to the VDD pin as close as possible is enough to get a good supply noise rejection. The capacitor location on both the bypass pin and power supply pin should be as close to the device as possible. Connecting a 1uF capacitor, C_B , between the bypass pin and ground improves the internal bias voltage's stability and improves the amplifier's PSRR. The PSRR improvements increase as the bypass pin capacitor value increases. The selection of bypass capacitors, especially C_B , depends on desired PSRR requirements, click and pop performance as explained in the section, **Proper Selection of External Components**, system cost, and size constraints.

Shutdown Function

In order to reduce power consumption while not in use, the FAN7024 contains a shutdown function(pin 1) to externally turn off the amplifier's bias circuitry. This shutdown feature turns the amplifier off when a logic high is placed on the shutdown pin. The trigger point between a logic low and high level is typically half supply. It is best to switch between ground and supply to provide maximum device performance. By switching the shutdown pin to the VDD, the supply current of the FAN7024 will be minimized in the shutdown mode. While the device is disabled with shutdown pin voltages less than VDD, the shutdown current may be greater than the typical value of 0.1uA. In either case, the shutdown pin should be tied to a definite voltage because leaving the pin floating may result in an unwanted state change. In many applications, a microcontroller or microprocessor output is used to control the shutdown circuitry which provides a quick, smooth transition into shutdown. Another solution is to use a single-pole, single-throw switch in conjunction with an external pull-up resistor. When the switch is closed, the shutdown pin is connected to ground and the device is enabled. If the switch is open, the FAN7024 will be disabled through the external pull-up resistor. This scheme guarantees that the shutdown pin will not float. This prevents unwanted state changes.

Bridge Configuration Explantion

As shown in typical appliction circuit, the FAN7024 has two operational amplifiers internally, allowing for a few different amplifier configurations. The first amplifier's gain is externally configurable, while the second amplifier is internally fixed in a unity-gain, inverting configuration. The close-loop gain of the first amplifier is set by selecting the ratio of R_F to R_I while the second amplifier's gain is fixed by two internal 20k Ω resistors. In the typical application circuit, the output of the first amplifier serves as the input of the second amplifier which results in both amplifiers producing signals indentical in magnitude, but out of phase 180°. Consequently the differential gain of the device is

$$A_{VD} = 2 \cdot \frac{R_F}{R_I} \quad (1)$$

By driving the load differentially through outputs V_{O1} and V_{O2} , an amplifier configuration commonly referred to as "bridged mode" is established. Bridged mode operation is different from the classical single-ended amplifier configuration where one side of its load is connected to ground.

A bridge amplifier design has a few distinct advantages over the single-ended configuration, as it provides differential drive to the load, thus doubling output swing for a specified supply voltage. Four times the output power is possible as compared to a single-ended amplifier under the same conditions. This increase in attainable output power assumes that the amplifier is not current limited or clipped.

A bridge configuration, such as the one used in FAN7024, also creates a second advantage over single-ended amplifiers. Since the differential outputs, V_{O1} and V_{O2} , are biased at half-supply, no net DC voltage exists across the load. This eliminates the need for an output coupling capacitor which is required in a single supply, single-ended amplifier configuration. If an output coupling capacitor is not used in a single-ended configuration, the half-supply bias across the load would result in both increased internal IC power dissipation as well as permanant loudspeaker damage.

Adaptive Q-current Control Circuit

Among the several kinds of the analog amplifiers, a class-AB amplifier satisfies moderate total harmonic distortion(THD) and the efficiency. In general, the output distortion is proportional to the quiescent-current(Q-current) of the output stage, but power efficiency is inversely propotional to that. To satisfy both needs, an adaptive Q-current control(AQC) technique is proposed. The AQC circuit controls the Q-current with respect to the amount of the output distortion, whereas it is not activated when no input signals are applied or no output distortion is sensed.

Power Dissipation

Power dissipation is a major concern when designing any power amplifier and must be thoroughly understood to ensure a successful design. Equation (2) states the maximum power dissipation point for a bridged amplifier operating at a given supply voltage and driving a specified output load.

$$P_{D\text{MAX}} = 4 \cdot \frac{V_{DD}^2}{2\pi^2 R_L} \quad (2)$$

Since the FAN7024 is driving a bridged amplifier, the internal maximum power dissipation point of the FAN7024 results from equation (2). Even with the large internal power dissipation, the FAN7024 does not require heat sinking over a wide range of ambient temperature. From equation (2), assuming a 5V power supply and an 8Ω load, the maximum power dissipation point is 633mW. The maximum power dissipation point obtained from equation (2) must not be greater than the power dissipation that results from equation (3) :

$$P_{D\text{MAX}} = \frac{(T_{J\text{MAX}} - T_A)}{R_{thja}} \quad (3)$$

For package 8MSOP(FAN7024MU), $R_{thja}=190^\circ\text{C}/\text{W}$, $T_{J\text{MAX}}=150^\circ\text{C}$ for the FAN7024.

Depending on the ambient temperature, T_A , of the system surroundings, equation (3) can be used to find the maximum internal power dissipation supported by the IC packaging. If the result of equation (2) is greater than that of equation (3), then decrease the supply voltage, increase the load impedance, or reduce the ambient temperature, T_A . If these measures are insufficient, a heat sink can be added to reduce T_A . For the typical application of a 5V power supply, with 8Ω load, the maximum ambient temperature possible without violating the maximum junction temperature is approximately 30°C provided that device operation is around the power dissipation point. Internal power dissipation is a function of output power and thus, if typical operation is not around the maximum power dissipation point, the ambient temperature can be increased. Refer to the **Performance Characteristics** curves for power dissipation information for lower output powers.

Proper Selection of External Components

Selection of external components in applications using integrated power amplifiers is critical to optimize device and system performance. While the FAN7024 is tolerant of external component combinations, consideration to component values must be used to maximize overall system quality. The FAN7024 is unity-gain stable and this gives a designer maximum system flexibility. The FAN7024 should be used in low gain configurations to minimize THD+N values and maximize the signal-to-noise ratio. Low gain configurations require large input signals to obtain a given output power. Besides gain, one of the major considerations is the closed-loop bandwidth of the amplifier. The input coupling capacitor, C_I , forms a first order high pass filter which limits low frequency response. This value should be chosen based on needed frequency response for a few distinct reasons.

Selection of Capacitor Size

In the typical application, an input capacitor, C_I , is required to allow the amplifier to bias the input signal to the proper DC level for optimum operation. In this case, C_I and R_I form a high-pass filter with the corner frequency

$$f_c = \frac{1}{2\pi R_I C_I} \quad (4)$$

The value of C_I is important to consider, as it directly affects the bass(low frequency) performance of the circuit. Clearly a certain sized capacitor is needed to couple in low frequencies without severe attenuation. But in many cases the speakers used in portable systems, whether internal or external, have little ability to reproduce signals below 150Hz. Thus using large input capacitor may not increase system performance. In addition to system cost and size, click and pop performance is affected by the size of the input coupling capacitor, C_I . A larger input coupling capacitor requires more charge to reach its quiescent DC voltage(normally $V_{DD}/2$). This charge comes from the output via feedback and is apt to create pops upon device enable. Thus, by minimizing the capacitor size based on necessary low frequency response, turn-on pops can be minimized.

Besides minimizing the input capacitor sizes, careful consideration should be paid to the bypass capacitor value. Bypass capacitor, C_B , is the most critical component to minimize turn-on pops since it determines how fast the FAN7024 turns on. The slower the FAN7024's outputs ramp to their quiescent DC voltage(normally $V_{DD}/2$), the smaller the turn-on pop. Thus choosing C_B equal to 1.0uF along with a small value of C_I (in the range of 0.1uF to 0.39uF), should produce a clickless and popless shutdown function. While the device will function properly, (no oscillations or motorboating), with C_B equal to 0.1uF, the device will be much more susceptible to turn-on clicks and pops. Thus, a value of C_B equal to 1uF or larger is recom-

mended in all but the most cost sensitive designs.

Pop Noise Reduction

The FAN7024 contains circuitry to minimize turn-on and shutdown transients or 'clicks and pop'. For this discussion, turn-on refers to either applying the power supply voltage or when the shutdown mode is deactivated.

To reduce the pop noise, the FAN7024 has some delay. During that delay, the input capacitor is precharged and the normal operation is prepared. Such delay time can be controlled by choosing C_B . The delay time is expressed as

$$t_{\text{delay}} = 2.5V \cdot \frac{C_B}{40\mu\text{A}} + 20\text{ms} \quad (5)$$

Mechanical Dimensions

Package

Dimensions in millimeters

8MSOP

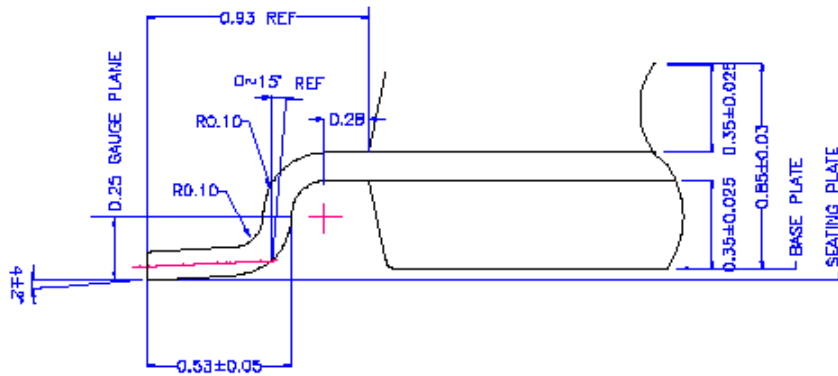
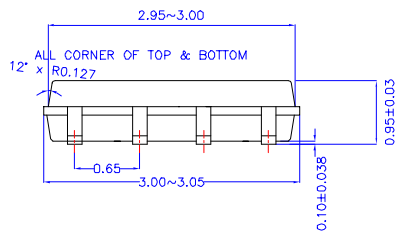
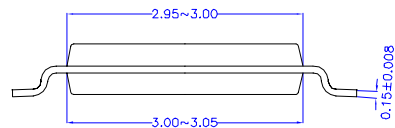
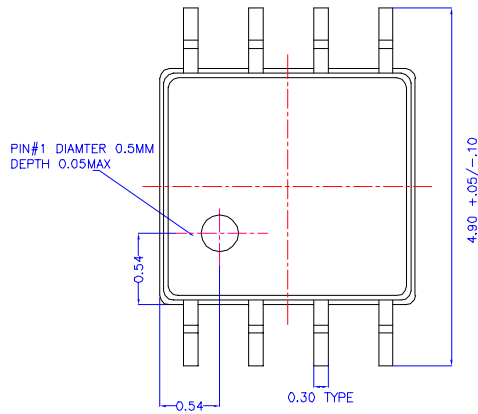

Mechanical Dimensions

Package

Dimensions in millimeters

10MLP

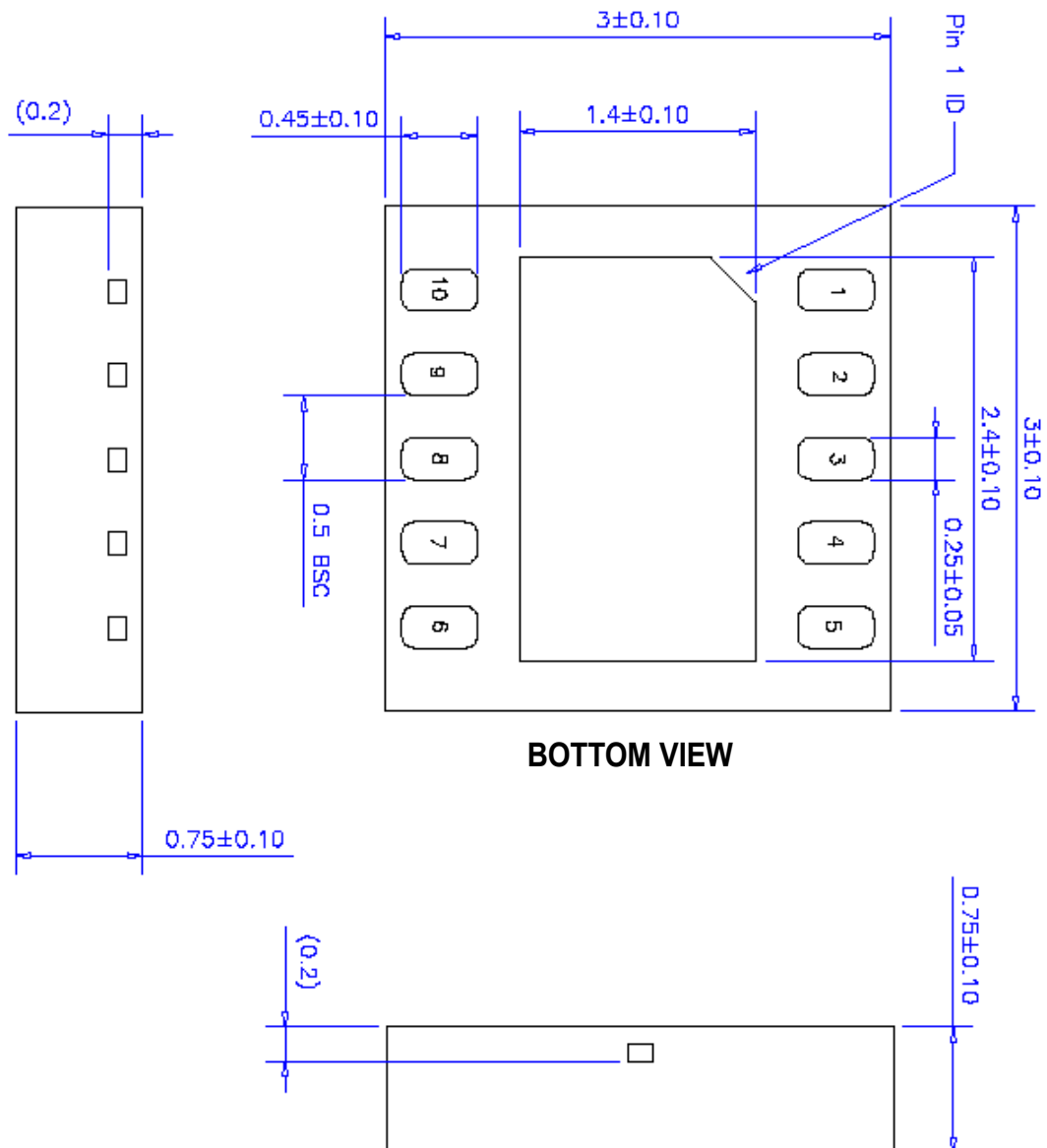

Ordering Information

Device	Package	Operating Temperature	Packing
FAN7024MU	8MSOP	-40°C ~ +85°C	Tube
FAN7024MUX			Tape& Reel
FAN7024MPX	10MLP		Tape& Reel

DISCLAIMER

FAIRCHILD SEMICONDUCTOR RESERVES THE RIGHT TO MAKE CHANGES WITHOUT FURTHER NOTICE TO ANY PRODUCTS HEREIN TO IMPROVE RELIABILITY, FUNCTION OR DESIGN. FAIRCHILD DOES NOT ASSUME ANY LIABILITY ARISING OUT OF THE APPLICATION OR USE OF ANY PRODUCT OR CIRCUIT DESCRIBED HEREIN; NEITHER DOES IT CONVEY ANY LICENSE UNDER ITS PATENT RIGHTS, NOR THE RIGHTS OF OTHERS.

LIFE SUPPORT POLICY

FAIRCHILD'S PRODUCTS ARE NOT AUTHORIZED FOR USE AS CRITICAL COMPONENTS IN LIFE SUPPORT DEVICES OR SYSTEMS WITHOUT THE EXPRESS WRITTEN APPROVAL OF THE PRESIDENT OF FAIRCHILD SEMICONDUCTOR CORPORATION. As used herein:

1. Life support devices or systems are devices or systems which, (a) are intended for surgical implant into the body, or (b) support or sustain life, and (c) whose failure to perform when properly used in accordance with instructions for use provided in the labeling, can be reasonably expected to result in a significant injury of the user.
2. A critical component in any component of a life support device or system whose failure to perform can be reasonably expected to cause the failure of the life support device or system, or to affect its safety or effectiveness.