

TOSHIBA BIPOLAR LINEAR INTEGRATED CIRCUIT SILICON MONOLITHIC

# TA75W558FU

## DUAL OPERATIONAL AMPLIFIER

TA75W558FU is a low-noise monolithic precision operational amplifier.

### FEATURES

- Internal Frequency Compensation Type.
- Pin Compatible with TA75W01FU.
- Wide Band Range :  $f_T = 3\text{MHz}$  (Typ.)
- Noise Voltage Range :  $V_{NI} = 2.5\mu\text{V}_{\text{rms}}$  (Typ.)
- Power Supply Range :  $\pm 4\text{V}_{\text{DC}}$  to  $\pm 18\text{V}_{\text{DC}}$
- Suitable Application for Active Filter Equalizer Amplifier and Headphone Amplifier.

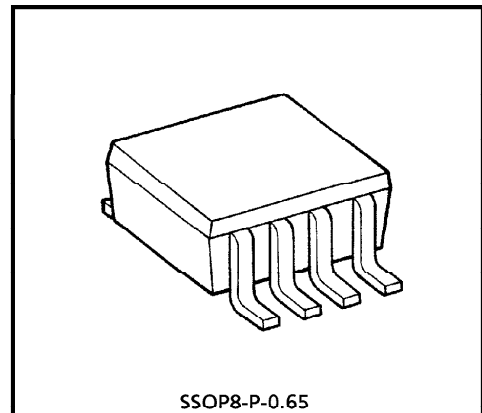

SSOP8-P-0.65

Weight : 0.021g (Typ.)

### MARKING (TOP VIEW)

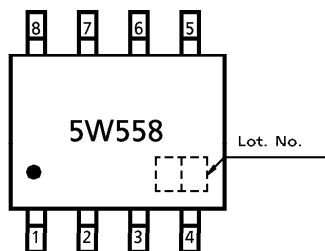

### PIN CONNECTION (TOP VIEW)

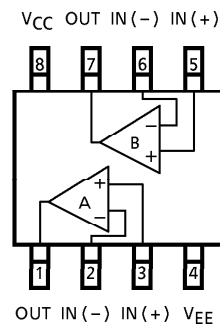

961001EBA2

● TOSHIBA is continually working to improve the quality and the reliability of its products. Nevertheless, semiconductor devices in general can malfunction or fail due to their inherent electrical sensitivity and vulnerability to physical stress. It is the responsibility of the buyer, when utilizing TOSHIBA products, to observe standards of safety, and to avoid situations in which a malfunction or failure of a TOSHIBA product could cause loss of human life, bodily injury or damage to property. In developing your designs, please ensure that TOSHIBA products are used within specified operating ranges as set forth in the most recent products specifications. Also, please keep in mind the precautions and conditions set forth in the TOSHIBA Semiconductor Reliability Handbook.

● The products described in this document are subject to foreign exchange and foreign trade control laws.

● The information contained herein is presented only as a guide for the applications of our products. No responsibility is assumed by TOSHIBA CORPORATION for any infringements of intellectual property or other rights of the third parties which may result from its use. No license is granted by implication or otherwise under any intellectual property or other rights of TOSHIBA CORPORATION or others.

● The information contained herein is subject to change without notice.

**EQUIVALENT CIRCUIT**

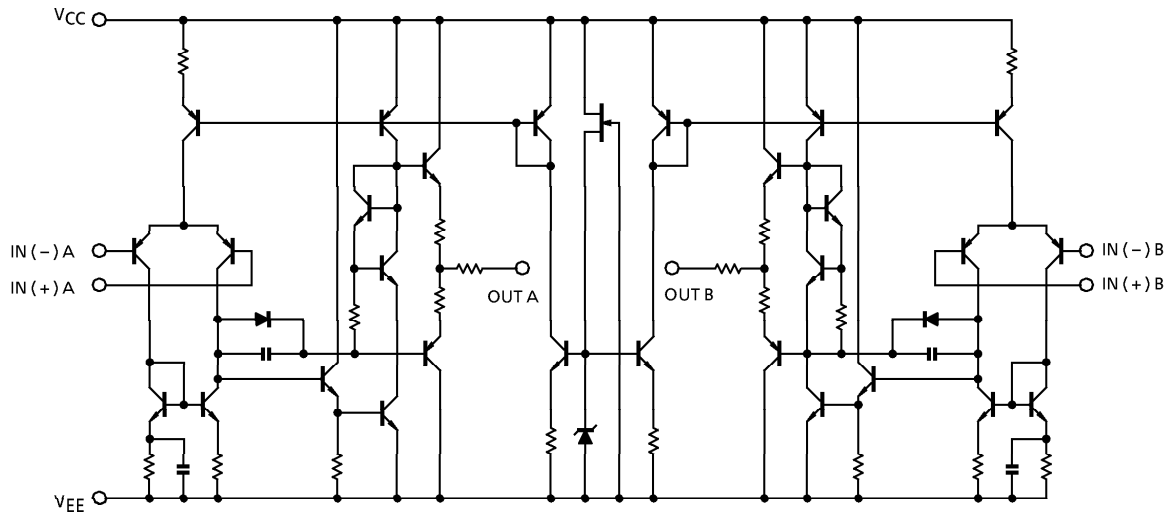

**MAXIMUM RATINGS (Ta = 25°C)**

CHARACTERISTIC	SYMBOL	RATING	UNIT
Supply Voltage	V <sub>CC</sub> , V <sub>EE</sub>	± 18	V
Differential Input Voltage	DV <sub>IN</sub>	± 30	V
Input Voltage	V <sub>IN</sub>	V <sub>EE</sub> ~V <sub>CC</sub>	V
Power Dissipation	P <sub>D</sub>	250	mW
Operating Temperature	T <sub>opr</sub>	- 40~85	°C
Storage Temperature	T <sub>stg</sub>	- 55~125	°C

ELECTRICAL CHARACTERISTICS ( $V_{CC} = 15V$ ,  $V_{EE} = -15V$ ,  $T_a = 25^\circ C$ )

CHARACTERISTICS	SYMBOL	TEST CIR-CUIT	TEST CONDITION	MIN.	TYP.	MAX.	UNIT
Input Offset Voltage	$V_{IO}$	—	$R_g \leq 10k\Omega$	—	0.5	6	mV
Input Offset Current	$I_{IO}$	—	—	—	5	200	nA
Input Bias Current	$I_I$	—	—	—	60	500	nA
Common Mode Input Voltage	$CMV_{IN}$	—	—	$\pm 12$	$\pm 14$	—	V
Maximum Output Voltage	$V_{OM}$	—	$R_L = 10k\Omega$	$\pm 12$	$\pm 14$	—	V
	$V_{OMR}$	—	$R_L = 2k\Omega$	$\pm 10$	$\pm 13$	—	
Source Current	$I_{source}$	—	—	—	40	—	mA
Sink Current	$I_{sink}$	—	—	—	40	—	mA
Voltage Gain (Open Loop)	$G_V$	—	$V_{OUT} = \pm 10V$ , $R_L = 2k\Omega$	86	100	—	dB
Common Mode Input Signal Rejection Ratio	CMRR	—	$R_g \leq 10k\Omega$	70	90	—	dB
Supply Voltage Rejection Ratio	SVRR	—	$R_g \leq 10k\Omega$	—	30	150	$\mu V/V$
Slew Rate	SR	—	$G_V = 1$ , $R_L = 2k\Omega$	—	1.0	—	V / $\mu s$
Unity Gain Cross Frequency	$f_T$	—	—	—	3.0	—	MHz
Supply Current	$I_{CC}$	—	—	—	4.0	6.0	mA
Equivalent Input Noise Voltage	$V_{NI}$	—	$R_S = 1k\Omega$ , $f = 30Hz \sim 30kHz$	—	2.5	—	$\mu V_{rms}$

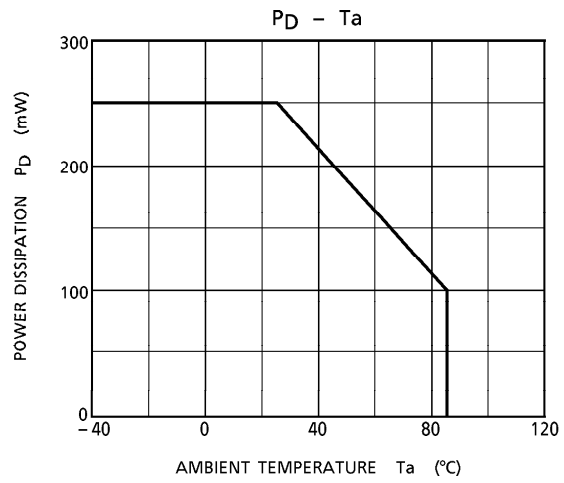
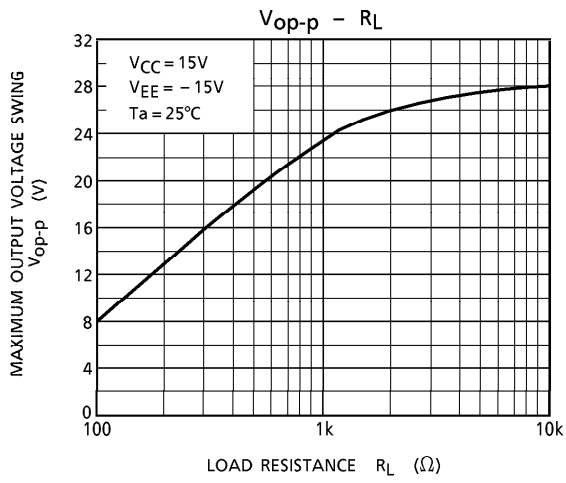
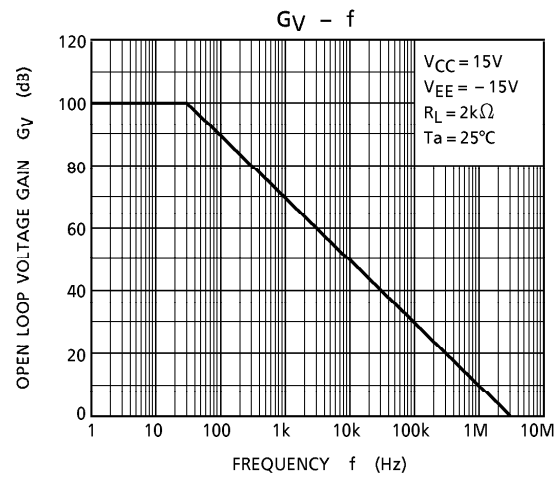
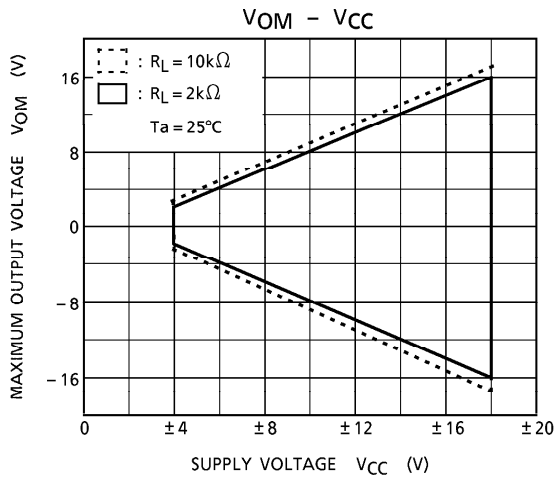

OUTLINE DRAWING  
SSOP8-P-0.65

Unit : mm

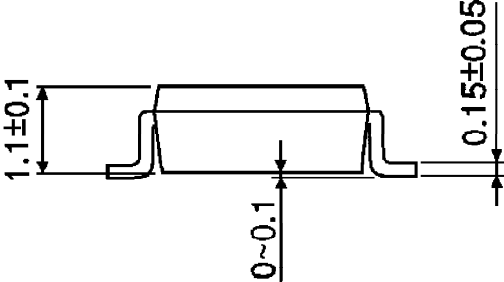
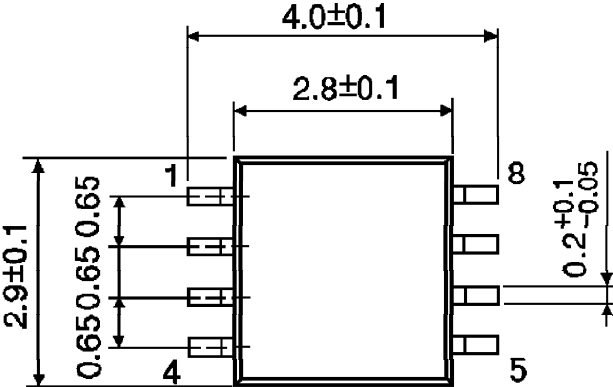

Weight : 0.021g (Typ.)