

**MAXIM**

# Ultra-Small, Low-Cost, 210MHz, Dual-Supply Op Amps with Rail-to-Rail Outputs

## General Description

The MAX4350 single and MAX4351 dual op amps are unity-gain-stable devices that combine high-speed performance with Rail-to-Rail® outputs. Both devices operate from dual  $\pm 5V$  supplies. The common-mode input voltage range extends to the negative power-supply rail.

The MAX4350/MAX4351 require only 6.9mA of quiescent supply current per op amp while achieving a 210MHz -3dB bandwidth and a 485V/ $\mu s$  slew rate. Both devices are excellent solutions in low-power systems that require wide bandwidth, such as video, communications, and instrumentation.

The MAX4350 is available in an ultra-small 5-pin SC70 package and the MAX4351 is available in a space-saving 8-pin SOT23 package.

## Applications

Set-Top Boxes  
Surveillance Video Systems  
Video Line Drivers  
Analog-to-Digital Converter Interface  
CCD Imaging Systems  
Video Routing and Switching Systems  
Digital Cameras

## Typical Operating Circuit

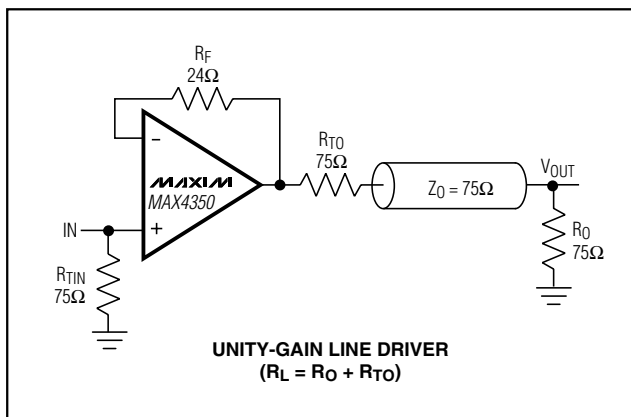

Rail-to-Rail is a registered trademark of Nippon Motorola, Ltd.

## Features

- ◆ Ultra-Small 5-Pin SC70, 5-Pin SOT23, and 8-Pin SOT23 Packages
- ◆ Low Cost
- ◆ High Speed
  - 210MHz -3dB Bandwidth
  - 55MHz 0.1dB Gain Flatness
  - 485V/ $\mu s$  Slew Rate
- ◆ Rail-to-Rail Outputs
- ◆ Input Common-Mode Range Extends to  $V_{EE}$
- ◆ Low Differential Gain/Phase: 0.02%/0.08°
- ◆ Low Distortion at 5MHz
  - 65dBc SFDR
  - 63dB Total Harmonic Distortion

## Ordering Information

PART	TEMP. RANGE	PIN-PACKAGE	TOP MARK
MAX4350EXK-T	-40°C to +85°C	5 SC70-5	ACF
MAX4350EUK-T	-40°C to +85°C	5 SOT23-5	ADRA
MAX4351EKA-T	-40°C to +85°C	8 SOT23-8	AAIC
MAX4351ESA	-40°C to +85°C	8 SO	—

## Pin Configurations

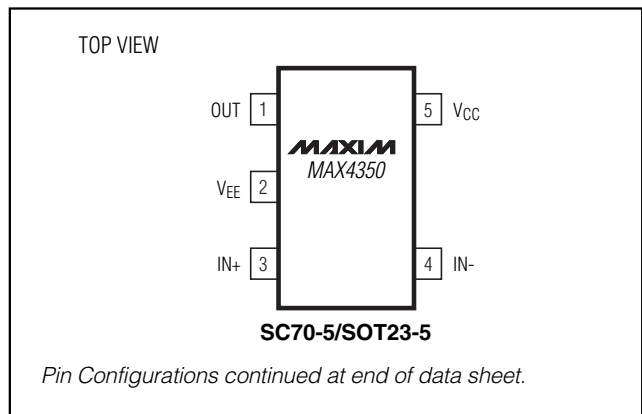
**MAXIM**

Maxim Integrated Products 1

For pricing, delivery, and ordering information, please contact Maxim/Dallas Direct! at 1-888-629-4642, or visit Maxim's website at [www.maxim-ic.com](http://www.maxim-ic.com).

**MAX4350/MAX4351**

# Ultra-Small, Low-Cost, 210MHz, Dual-Supply Op Amps with Rail-to-Rail Outputs

## ABSOLUTE MAXIMUM RATINGS

Supply Voltage ( $V_{CC}$ to $V_{EE}$ ).....	+12V	8-Pin SOT23 (derate 5.26mW/°C above +70°C) .....	421mW
$IN_-$ , $IN_+$ , $OUT_-$ .....	( $V_{EE} - 0.3V$ ) to ( $V_{CC} + 0.3V$ )	8-Pin SO (derate 5.9mW/°C above +70°C) .....	471mW
Output Short-Circuit Current to $V_{CC}$ or $V_{EE}$ .....	150mA	Operating Temperature Range .....	-40°C to +85°C
Continuous Power Dissipation ( $T_A = +70^\circ C$ )		Storage Temperature Range .....	-65°C to +150°C
5-Pin SC70 (derate 2.5mW/°C above +70°C) .....	200mW	Lead Temperature (soldering, 10s) .....	+300°C
5-Pin SOT23 (derate 7.1mW/°C above +70°C) .....	571mW		

Stresses beyond those listed under "Absolute Maximum Ratings" may cause permanent damage to the device. These are stress ratings only, and functional operation of the device at these or at any other conditions beyond those indicated in the operational sections of the specifications is not implied. Exposure to absolute maximum rating conditions for extended periods may affect device reliability.

## DC ELECTRICAL CHARACTERISTICS

( $V_{CC} = +5V$ ,  $V_{EE} = -5V$ ,  $R_L = \infty$  to 0,  $V_{OUT} = 0$ ,  $T_A = T_{MIN}$  to  $T_{MAX}$ , unless otherwise noted. Typical values are at  $T_A = +25^\circ C$ .) (Note 1)

PARAMETER	SYMBOL	CONDITIONS	MIN	TYP	MAX	UNITS
Input Common-Mode Voltage Range	$V_{CM}$	Guaranteed by CMRR test	$V_{EE}$		$V_{CC} - 2.25$	V
Input Offset Voltage	$V_{OS}$			1	26	mV
Input Offset Voltage Matching		MAX4351 only		1		mV
Input Offset Voltage Temperature Coefficient	$TC_{VOS}$			8		$\mu V/^\circ C$
Input Bias Current	$I_B$			7.5	20	$\mu A$
Input Offset Current	$I_{OS}$			0.5	4	$\mu A$
Input Resistance	$R_{IN}$	Differential mode ( $-1V \leq V_{IN} \leq +1V$ )		70		k $\Omega$
		Common mode ( $-5V \leq V_{CM} \leq +2.75V$ )		3		M $\Omega$
Common-Mode Rejection Ratio	CMRR	$V_{EE} \leq V_{CM} \leq (V_{CC} - 2.25V)$	70	95		dB
Open-Loop Gain	$A_{VOL}$	$-4.5V \leq V_{OUT} \leq +4.5V$ , $R_L = 2k\Omega$	50	60		dB
		$-4.25V \leq V_{OUT} \leq +4.25V$ , $R_L = 150\Omega$	48	58		
		$-3.75V \leq V_{OUT} \leq +3.75V$ , $R_L = 75\Omega$		57		
Output Voltage Swing	$V_{OUT}$	$R_L = 2k\Omega$	$V_{CC} - V_{OH}$	0.125	0.350	V
			$V_{OL} - V_{EE}$	0.065	0.170	
		$R_L = 150\Omega$	$V_{CC} - V_{OH}$	0.525	0.750	
			$V_{OL} - V_{EE}$	0.370	0.550	
		$R_L = 75\Omega$	$V_{CC} - V_{OH}$	0.925	1.550	
			$V_{OL} - V_{EE}$	0.750	1.7	
Output Current	$I_{OUT}$	$R_L = 50\Omega$	Sourcing	55	80	mA
			Sinking	40	75	
Output Short-Circuit Current	$I_{SC}$	Sinking or sourcing		$\pm 120$		mA
Open-Loop Output Resistance	$R_{OUT}$			8		$\Omega$
Power-Supply Rejection Ratio	PSRR	$V_S = \pm 4.5V$ to $\pm 5.5V$	52	66		dB
Operating Supply-Voltage Range	$V_S$	$V_{CC}$ , $V_{EE}$	$\pm 4.5$		$\pm 5.5$	V
Quiescent Supply Current (Per Amplifier)	$I_S$			6.9	9.0	mA

# Ultra-Small, Low-Cost, 210MHz, Dual-Supply Op Amps with Rail-to-Rail Outputs

**MAX4350/MAX4351**

## AC ELECTRICAL CHARACTERISTICS

( $V_{CC} = +5V$ ,  $V_{EE} = -5V$ ,  $V_{CM} = 0$ ,  $R_F = 24\Omega$ ,  $R_L = 100\Omega$  to 0,  $A_{VCL} = +1V/V$ ,  $T_A = +25^\circ C$ , unless otherwise noted.)

PARAMETER	SYMBOL	CONDITIONS	MIN	TYP	MAX	UNITS
Small-Signal -3dB Bandwidth	BW <sub>SS</sub>	$V_{OUT} = 100mV_{p-p}$		210		MHz
Large-Signal -3dB Bandwidth	BW <sub>LS</sub>	$V_{OUT} = 2V_{p-p}$		175		MHz
Bandwidth for 0.1dB Gain Flatness	BW <sub>0.1dB</sub>	$V_{OUT} = 100mV_{p-p}$		55		MHz
		$V_{OUT} = 2V_{p-p}$		40		
Slew Rate	SR	$V_{OUT} = 2V$ step		485		V/ $\mu s$
Settling Time to 0.1%	t <sub>S</sub>	$V_{OUT} = 2V$ step		16		ns
Rise/Fall Time	t <sub>R</sub> , t <sub>F</sub>	$V_{OUT} = 100mV_{p-p}$		4		ns
Spurious-Free Dynamic Range	SFDR	$f_C = 5MHz$ , $V_{OUT} = 2V_{p-p}$		-65		dBc
Harmonic Distortion	HD	$f_C = 5MHz$ , $V_{OUT} = 2V_{p-p}$	2nd harmonic		-65	dBc
			3rd harmonic		-58	
			Total harmonic distortion		-63	
Two-Tone, Third-Order Intermodulation Distortion	IP3	$f_1 = 4.7MHz$ , $f_2 = 4.8MHz$ , $V_{OUT} = 1V_{p-p}$		66		dBc
Channel-to-Channel Isolation	CH <sub>ISO</sub>	Specified at DC, MAX4351 only		102		dB
Input 1dB Compression Point		$f_C = 10MHz$ , $A_{VCL} = +2V/V$		14		dBm
Differential Phase Error	DP	NTSC, $R_L = 150\Omega$		0.08		degrees
Differential Gain Error	DG	NTSC, $R_L = 150\Omega$		0.02		%
Input Noise-Voltage Density	e <sub>N</sub>	$f = 10kHz$		10		nV/ $\sqrt{Hz}$
Input Noise-Current Density	i <sub>N</sub>	$f = 10kHz$		1.8		pA/ $\sqrt{Hz}$
Input Capacitance	C <sub>IN</sub>			1		pF
Output Impedance	Z <sub>OUT</sub>	$f = 10MHz$		1.5		$\Omega$

**Note 1:** All devices are 100% production tested at  $T_A = +25^\circ C$ . Specifications over temperature limits are guaranteed by design.

# Ultra-Small, Low-Cost, 210MHz, Dual-Supply Op Amps with Rail-to-Rail Outputs

## Typical Operating Characteristics

( $V_{CC} = +5V$ ,  $V_{EE} = -5V$ ,  $V_{CM} = 0$ ,  $A_{vCL} = +1V/V$ ,  $R_F = 24\Omega$ ,  $R_L = 100\Omega$  to  $0$ ,  $T_A = +25^\circ C$ , unless otherwise noted.)

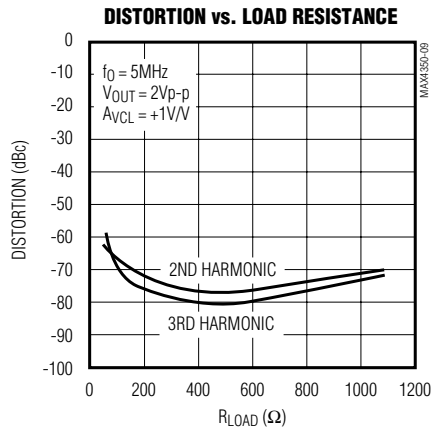
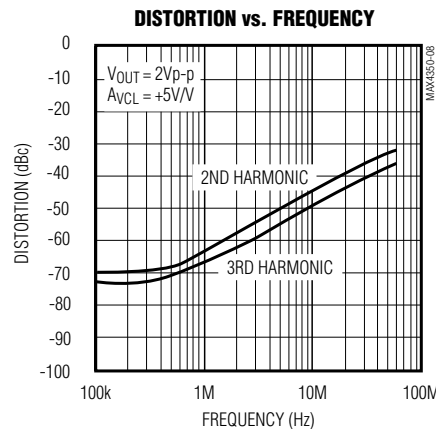
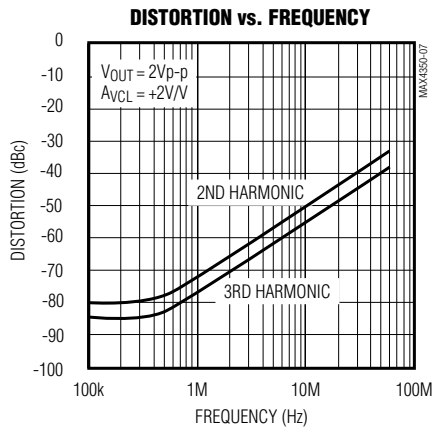
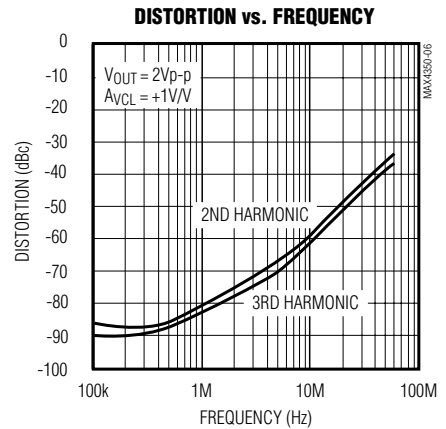
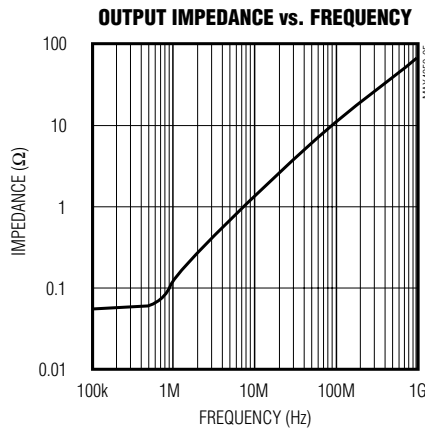
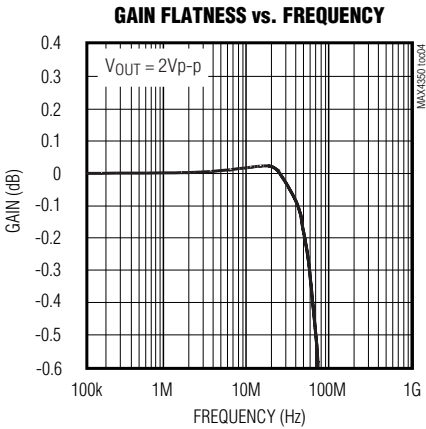
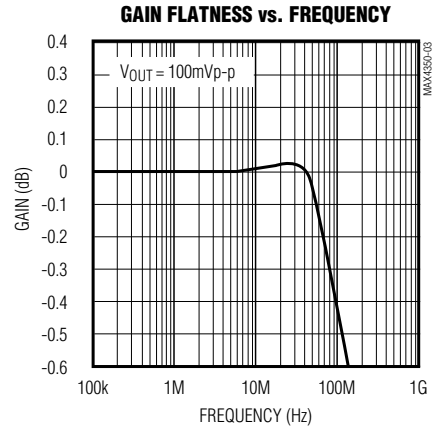
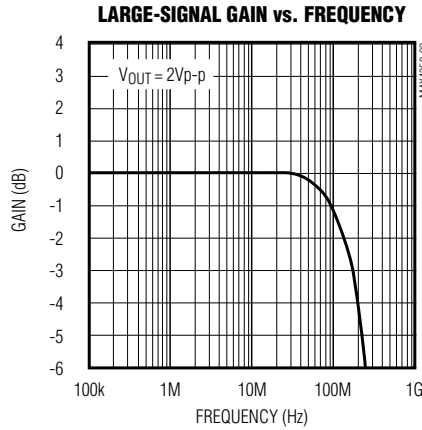
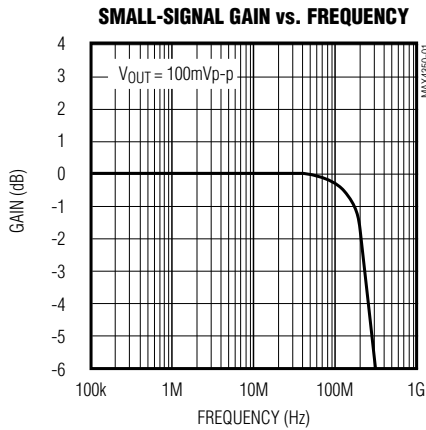

# Ultra-Small, Low-Cost, 210MHz, Single-Supply Op Amps with Rail-to-Rail Outputs

MAX4350/MAX4351

## Typical Operating Characteristics (continued)

( $V_{CC} = +5V$ ,  $V_{EE} = -5V$ ,  $V_{CM} = 0$ ,  $A_{vCL} = +1V/V$ ,  $R_F = 24\Omega$ ,  $R_L = 100\Omega$  to  $0$ ,  $T_A = +25^\circ C$ , unless otherwise noted.)

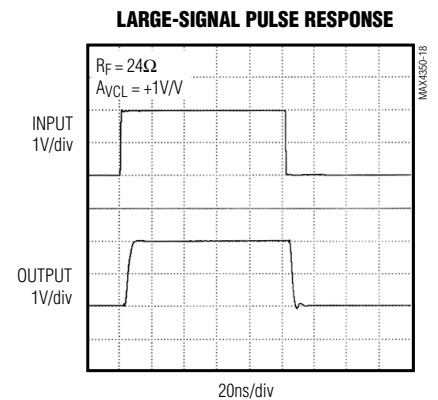
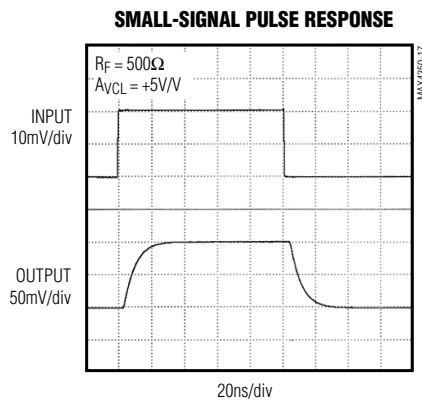
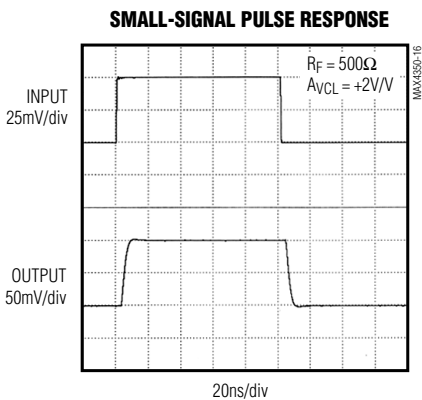
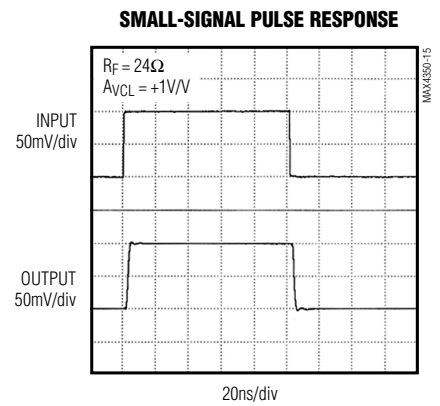
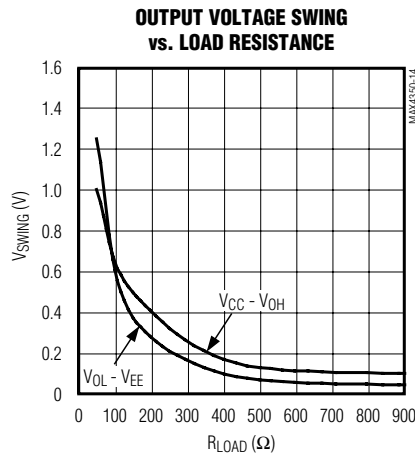
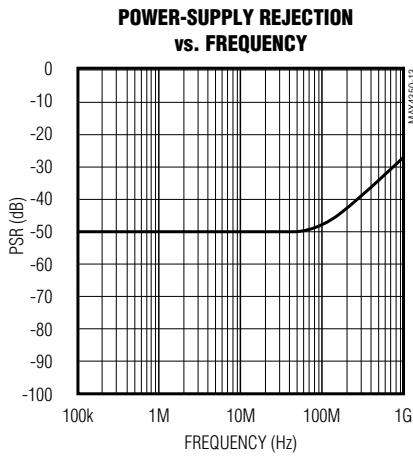
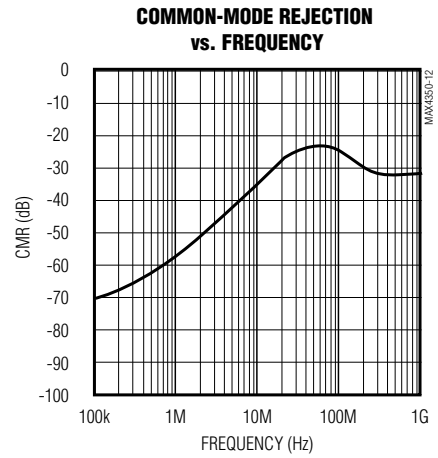
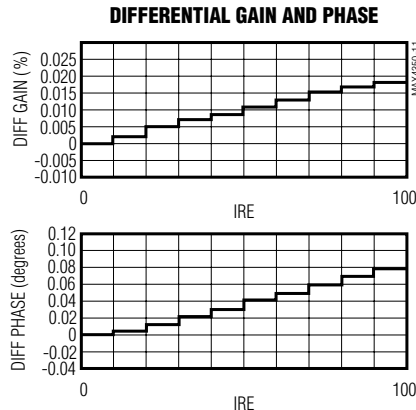
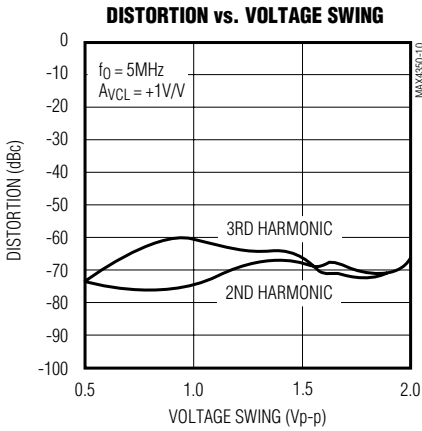

# Ultra-Small, Low-Cost, 210MHz, Dual-Supply Op Amps with Rail-to-Rail Outputs

## Typical Operating Characteristics (continued)

( $V_{CC} = +5V$ ,  $V_{EE} = -5V$ ,  $V_{CM} = 0$ ,  $A_{VCL} = +1V/V$ ,  $R_F = 24\Omega$ ,  $R_L = 100\Omega$  to  $0$ ,  $T_A = +25^\circ C$ , unless otherwise noted.)

**LARGE-SIGNAL PULSE RESPONSE**

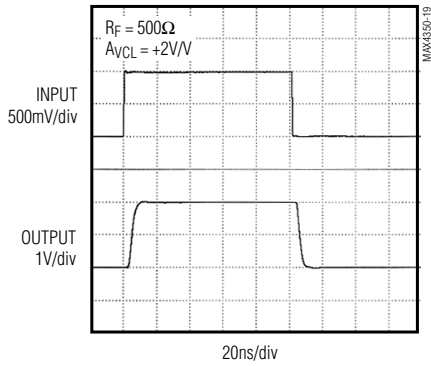

**LARGE-SIGNAL PULSE RESPONSE**

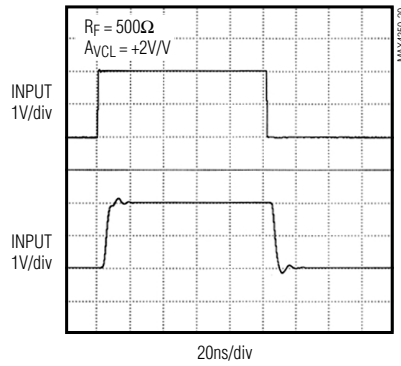

**VOLTAGE NOISE vs. FREQUENCY**

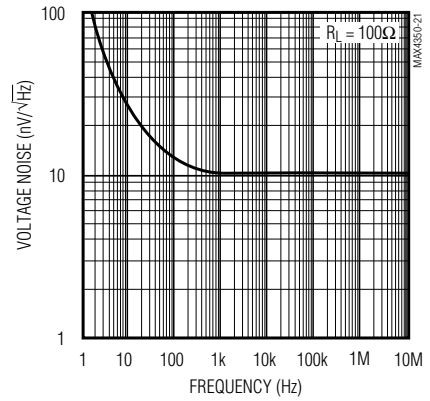

**CURRENT NOISE vs. FREQUENCY**

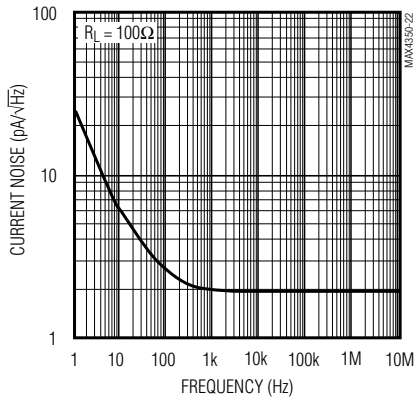

**ISOLATION RESISTANCE vs. CAPACITIVE LOAD**

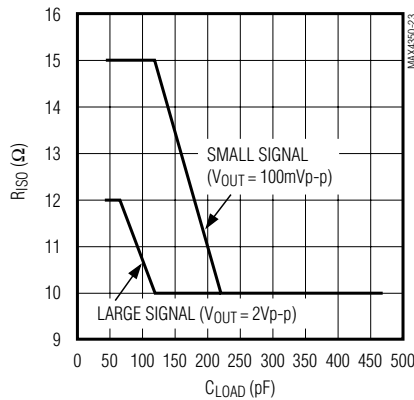

**SMALL-SIGNAL BANDWIDTH vs. LOAD RESISTANCE**

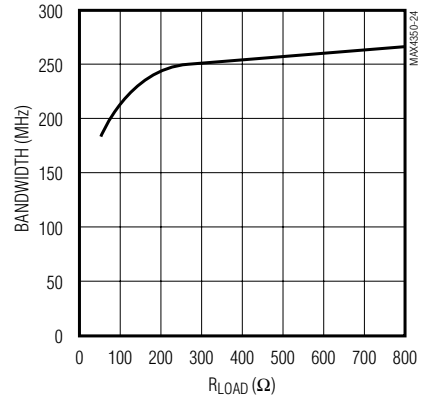

**OPEN-LOOP GAIN vs. LOAD RESISTANCE**

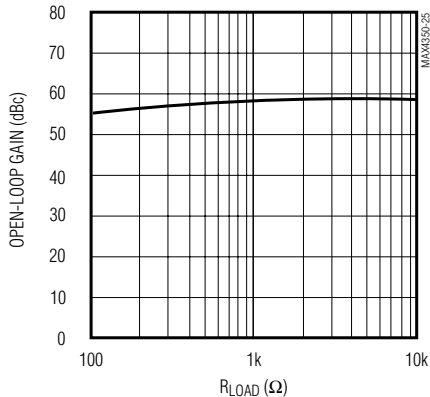

**MAX4351 CROSSTALK vs. FREQUENCY**

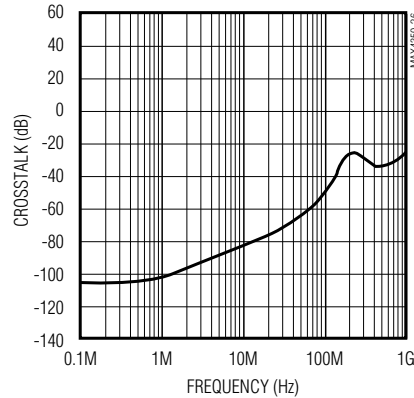

# Ultra-Small, Low-Cost, 210MHz, Dual-Supply Op Amps with Rail-to-Rail Outputs

MAX4350/MAX4351

## Pin Description

PIN		NAME	FUNCTION
MAX4350	MAX4351		
1	—	OUT	Amplifier Output
2	4	VEE	Negative Power Supply or Ground (in single-supply operation)
3	—	IN+	Noninverting Input
4	—	IN-	Inverting Input
5	8	VCC	Positive Power Supply
—	1	OUTA	Amplifier A Output
—	2	INA-	Amplifier A Inverting Input
—	3	INA+	Amplifier A Noninverting Input
—	7	OUTB	Amplifier B Output
—	6	INB-	Amplifier B Inverting Input
—	5	INB+	Amplifier B Noninverting Input

## Detailed Description

The MAX4350/MAX4351 are single-supply, rail-to-rail, voltage-feedback amplifiers that employ current-feedback techniques to achieve 485V/ $\mu$ s slew rates and 210MHz bandwidths. Excellent harmonic distortion and differential gain/phase performance make these amplifiers an ideal choice for a wide variety of video and RF signal-processing applications.

The output voltage swings to within 125mV of each supply rail. Local feedback around the output stage ensures low open-loop output impedance to reduce gain sensitivity to load variations. The input stage permits common-mode voltages beyond the negative supply and to within 2.25V of the positive supply rail.

## Applications Information

### Choosing Resistor Values

#### Unity-Gain Configuration

The MAX4350/MAX4351 are internally compensated for unity gain. When configured for unity gain, a 24 $\Omega$  resistor ( $R_F$ ) in series with the feedback path optimizes AC performance. This resistor improves AC response by reducing the Q of the parallel LC circuit formed by the parasitic feedback capacitance and inductance.

### Inverting and Noninverting Configurations

Select the gain-setting feedback ( $R_F$ ) and input ( $R_G$ ) resistor values to fit your application (Figures 1a and 1b). Large resistor values increase voltage noise and interact with the amplifier's input and PC board capacitance. This can generate undesirable poles and zeros and decrease bandwidth or cause oscillations. For example, a noninverting gain-of-two configuration ( $R_F = R_G$ ) using 1k $\Omega$  resistors, combined with 1pF of amplifier input capacitance and 1pF of PC board capacitance, causes a pole at 159MHz. Since this pole is within the amplifier bandwidth, it jeopardizes stability. Reducing the 1k $\Omega$  resistors to 100 $\Omega$  extends the pole frequency to 1.59GHz, but could limit output swing by adding 200 $\Omega$  in parallel with the amplifier's load resistor.

### Layout and Power-Supply Bypassing

These amplifiers operate from dual  $\pm$ 5V supplies. Bypass each supply with a 0.1 $\mu$ F capacitor to ground.

Maxim recommends using microstrip and stripline techniques to obtain full bandwidth. To ensure that the PC board does not degrade the amplifier's performance, design it for a frequency greater than 1GHz. Pay care-

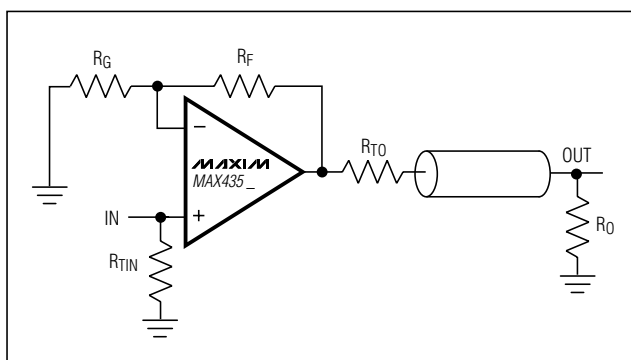

Figure 1a. Noninverting Gain Configuration

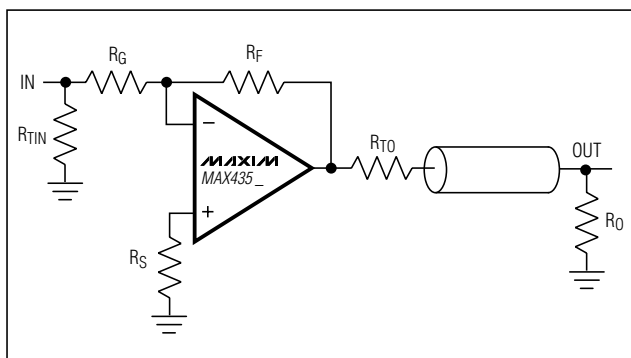

Figure 1b. Inverting Gain Configuration

# Ultra-Small, Low-Cost, 210MHz, Dual-Supply Op Amps with Rail-to-Rail Outputs

ful attention to inputs and outputs to avoid large parasitic capacitance. Whether or not you use a constant-impedance board, observe the following design guidelines:

- Don't use wire-wrap boards; they are too inductive.
- Don't use IC sockets; they increase parasitic capacitance and inductance.
- Use surface-mount instead of through-hole components for better high-frequency performance.
- Use a PC board with at least two layers; it should be as free from voids as possible.
- Keep signal lines as short and as straight as possible. Do not make 90° turns; round all corners.

## Rail-to-Rail Outputs, Ground-Sensing Input

The input common-mode range extends from VEE to (VCC - 2.25V) with excellent common-mode rejection. Beyond this range, the amplifier output is a nonlinear function of the input, but does not undergo phase reversal or latchup. The output swings to within 125mV of either power-supply rail with a 2kΩ load.

## Output Capacitive Load and Stability

The MAX4350/MAX4351 are optimized for AC performance. They are not designed to drive highly reactive loads, which decrease phase margin and may produce excessive ringing and oscillation. Figure 2 shows a circuit that eliminates this problem. Figure 3 is a graph of the Isolation Resistance (R<sub>ISO</sub>) vs. Capacitive Load. Figure 4 shows how a capacitive load causes excessive peaking of the amplifier's frequency response if the capacitor is not isolated from the amplifier by a resistor. A small isolation resistor (usually 20Ω to 30Ω) placed before the reactive load prevents ringing and oscillation. At higher capacitive loads, AC performance is controlled by the interaction of the load capacitance and the isolation resistor. Figure 5 shows the effect of a 27Ω isolation resistor on closed-loop response.

Coaxial cable and other transmission lines are easily driven when properly terminated at both ends with their characteristic impedance. Driving back-terminated transmission lines essentially eliminates the line's capacitance.

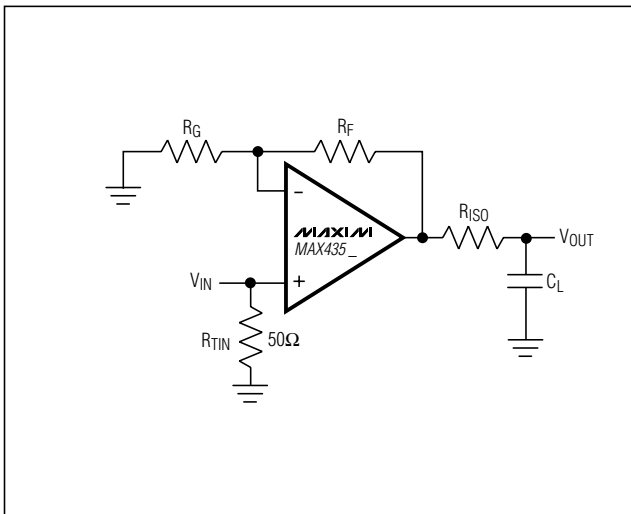

Figure 2. Driving a Capacitive Load Through an Isolation Resistor

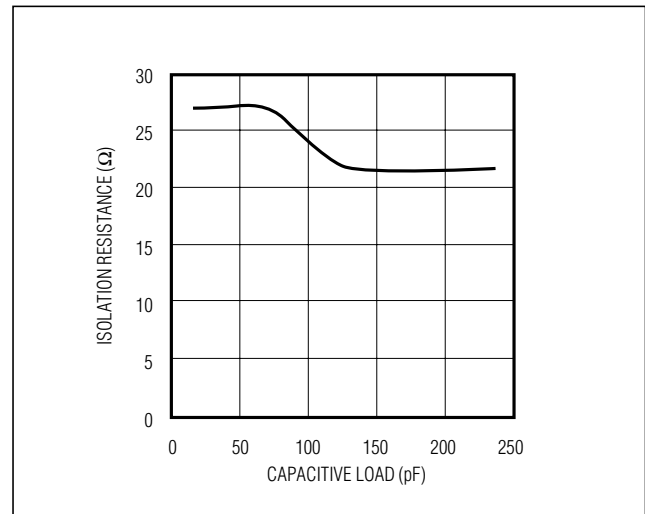

Figure 3. Isolation Resistance vs. Capacitive Load



# Ultra-Small, Low-Cost, 210MHz, Dual-Supply Op Amps with Rail-to-Rail Outputs

**MAX4350/MAX4351**

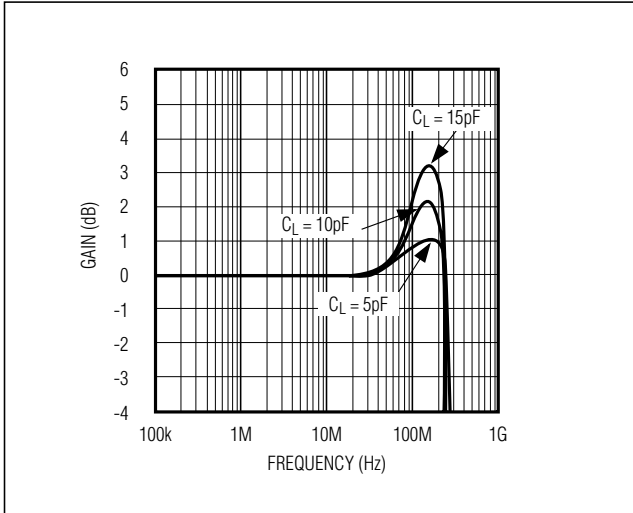

Figure 4. Small-Signal Gain vs. Frequency with Load Capacitance and No Isolation Resistor

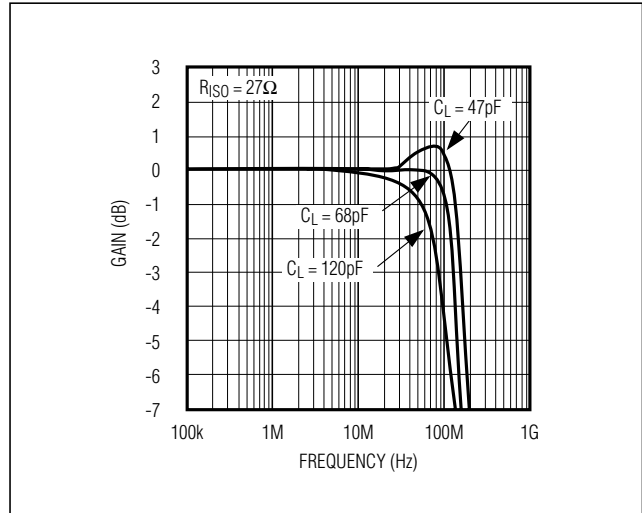
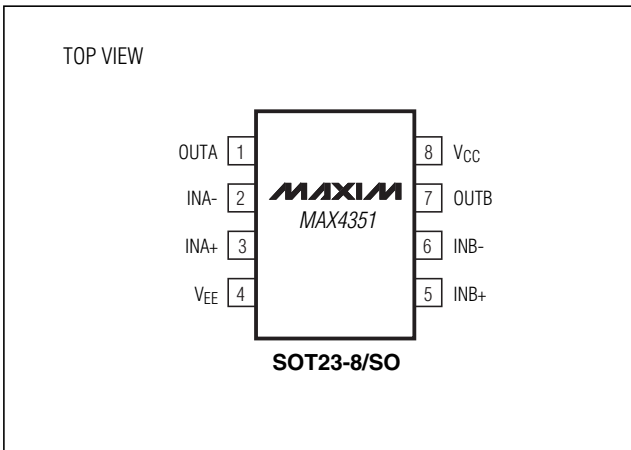

Figure 5. Small-Signal Gain vs. Frequency with Load Capacitance and 27Ω Isolation Resistor

## Pin Configurations (continued)



## Chip Information

MAX4350 TRANSISTOR COUNT: 86  
 MAX4351 TRANSISTOR COUNT: 170

# Ultra-Small, Low-Cost, 210MHz, Dual-Supply Op Amps with Rail-to-Rail Outputs

## Package Information

SYMBOL	MIN	MAX
e	0.65	BSC
D	1.80	2.20
b	0.15	0.30
E	1.15	1.35
HE	1.80	2.40
Q1	0.10	0.40
A2	0.60	1.00
A1	0.00	0.10
A	0.80	1.10
c	0.10	0.18
L	0.10	0.30
L1	0.425	TYP.

NOTE:

1. ALL DIMENSIONS ARE IN MILLIMETERS
2. DIMENSIONS ARE INCLUSIVE OF PLATING
3. DIMENSIONS ARE EXCLUSIVE OF MOLD FLASH & METAL BURR
4. ALL SPECIFICATIONS COMPLY TO EIAJ SC70
5. COPLANARITY 4 MILS. MAX.

SC70-5LEPS

**MAXIM**  
PROPRIETARY INFORMATION  
 TITLE:  
 PACKAGE OUTLINE, SC70, 5L  
 APPROVAL: \_\_\_\_\_ DOCUMENT CONTROL NO: 21-0076 REV: B 1/1

SYMBOL	MIN	MAX
A	0.90	1.45
A1	0.00	0.15
A2	0.90	1.30
b	0.35	0.50
C	0.08	0.20
D	2.80	3.00
E	2.60	3.00
E1	1.50	1.75
L	0.35	0.55
e	0.95	REF
e1	1.90	REF
alpha	0°	10°

NOTES:

1. ALL DIMENSIONS ARE IN MILLIMETERS.
2. FOOT LENGTH MEASURED AT INTERCEPT POINT BETWEEN DATUM A & LEAD SURFACE.
3. PACKAGE OUTLINE EXCLUSIVE OF MOLD FLASH & METAL BURR.
4. PACKAGE OUTLINE INCLUSIVE OF SOLDER PLATING.
5. MEETS JEDEC MO17B.

SOT-23

**MAXIM**  
PROPRIETARY INFORMATION  
 TITLE:  
 PACKAGE OUTLINE, SOT-23, 5L  
 APPROVAL: \_\_\_\_\_ DOCUMENT CONTROL NO: 21-0057 REV: C 1/1

# Ultra-Small, Low-Cost, 200MHz, Dual-Supply Op Amps with Rail-to-Rail Outputs

## Package Information (continued)

**MAX4350/MAX4351**

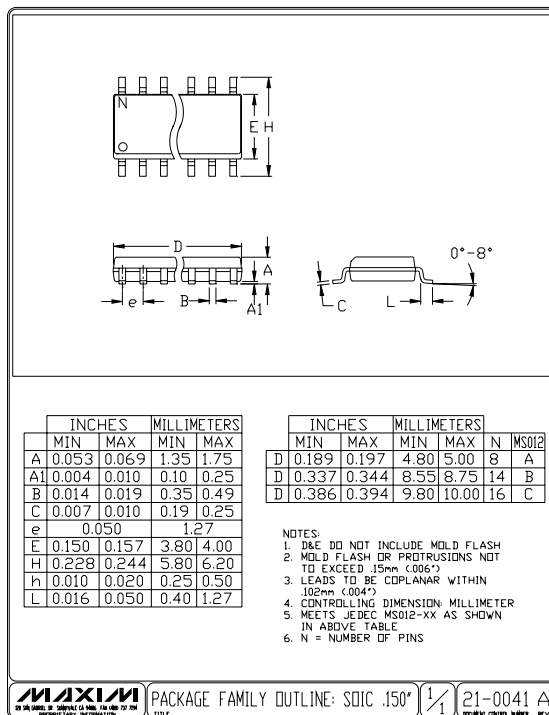
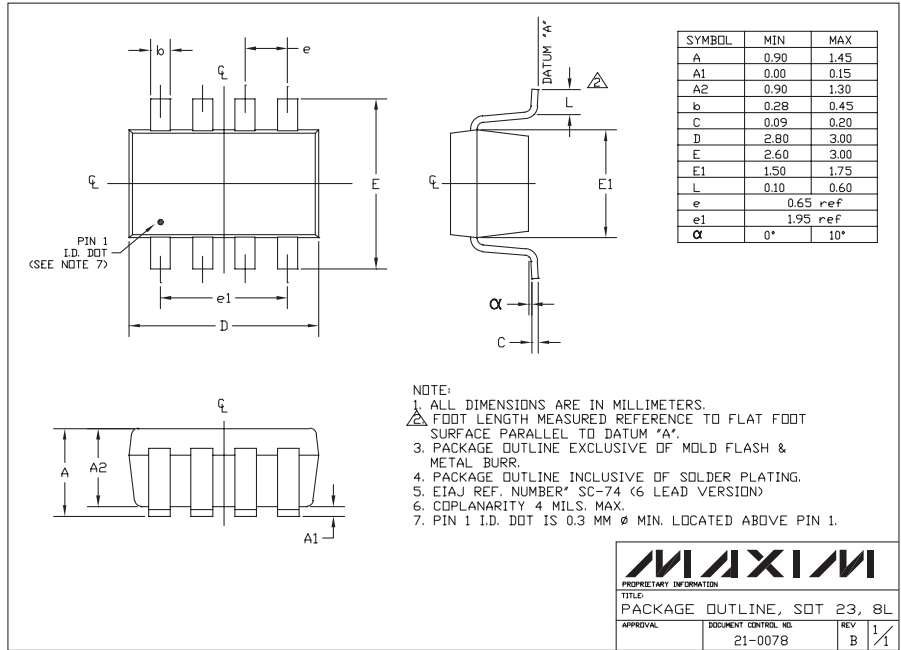

Maxim cannot assume responsibility for use of any circuitry other than circuitry entirely embodied in a Maxim product. No circuit patent licenses are implied. Maxim reserves the right to change the circuitry and specifications without notice at any time.

**Maxim Integrated Products, 120 San Gabriel Drive, Sunnyvale, CA 94086 408-737-7600** \_\_\_\_\_ 11