

MAXIM

MAX3971 Evaluation Kit

Evaluates: MAX3971

General Description

The MAX3971 evaluation kit (EV kit) simplifies evaluation of the MAX3971 10.3Gbps limiting amplifier. The EV kit enables testing of all the device's functions. SMA connectors with 50Ω controlled-impedance connections to the MAX3971 are provided for all data input and output ports to facilitate connection to high-speed test equipment.

Component List

DESIGNATION	QTY	DESCRIPTION
C1–C4	4	0.001μF ±10% ceramic capacitors (0402) Murata GRM36X7R102K050AD
C6, CZ	2	0.1μF ±10% ceramic capacitors (0603) Murata GRM39X7R104K016AD
C7	1	2.2μF ±10% ceramic capacitor (1206) Murata GRM42-6X7R225K016AD
C8	1	33μF ±10% tantalum capacitor AVX TAJC336K010
C9, C16–C21	0	Open
C11–C14	4	0.1μF ±10% ceramic capacitors (0402) Murata GRM36X5R104K010AD
J1–J4	4	SMA connectors (edge-mount, tab contact)
J6, J7	2	Test points Digi-Key 5000K-ND
J8–J14	0	Open
JU1	1	1 × 3-pin header (0.1in center)
L1	1	Murata BLM11HA102SG
R3, R4	0	Open
U1	1	MAX3971UGP (20 QFN)
None	1	Shunt
None	1	MAX3971 evaluation circuit board, Rev B
None	1	MAX3971 data sheet

Features

- ◆ SMA Connectors for All High-Speed Inputs and Outputs
- ◆ Fully Assembled and Tested
- ◆ Single 3.3V Power Supply

Ordering Information

PART	TEMP RANGE	IC PACKAGE
MAX3971EVKIT	0°C to +85°C	20 QFN*

*Exposed paddle

Component Suppliers

SUPPLIER	PHONE	FAX
AVX	843-444-2863	843-626-3123
Murata	415-964-6321	415-964-8165

Note: Please indicate that you are using the MAX3971 when contacting these component suppliers.

Quick Start

- 1) Connect a 3.3V power supply to J6 (VCC). Connect the power supply ground to J7.
- 2) Connect a differential or single-ended input signal (differential voltage amplitude between 10mVp-p and 800mVp-p) to the inputs (IN+ and IN-) by using SMA cables suitable for 10.3GHz use.
- 3) Connect a 50Ω oscilloscope to the SMA connectors J3 and J4 (OUT+, OUT-) to observe the output of the limiter. The output signal is approximately 200mVp-p to 400mVp-p differential.
- 4) To disable the output signals OUT+ and OUT-, jumper the three-pin header JU1 from the center pin (pin 2) to VCC (pin 1). To enable the output signals, jumper should be from pin 2 to ground (pin 3).

Notes

- 1) At high frequencies such as from 1GHz to 10GHz, delays with the board and cables affect measurements. Mismatches in cables can cause significant measurement errors. Edge speeds are best observed by using single-ended methods. Careful calibration of cables, attenuators and the board is necessary.

MAX3971 Evaluation Kit

Evaluates: MAX3971

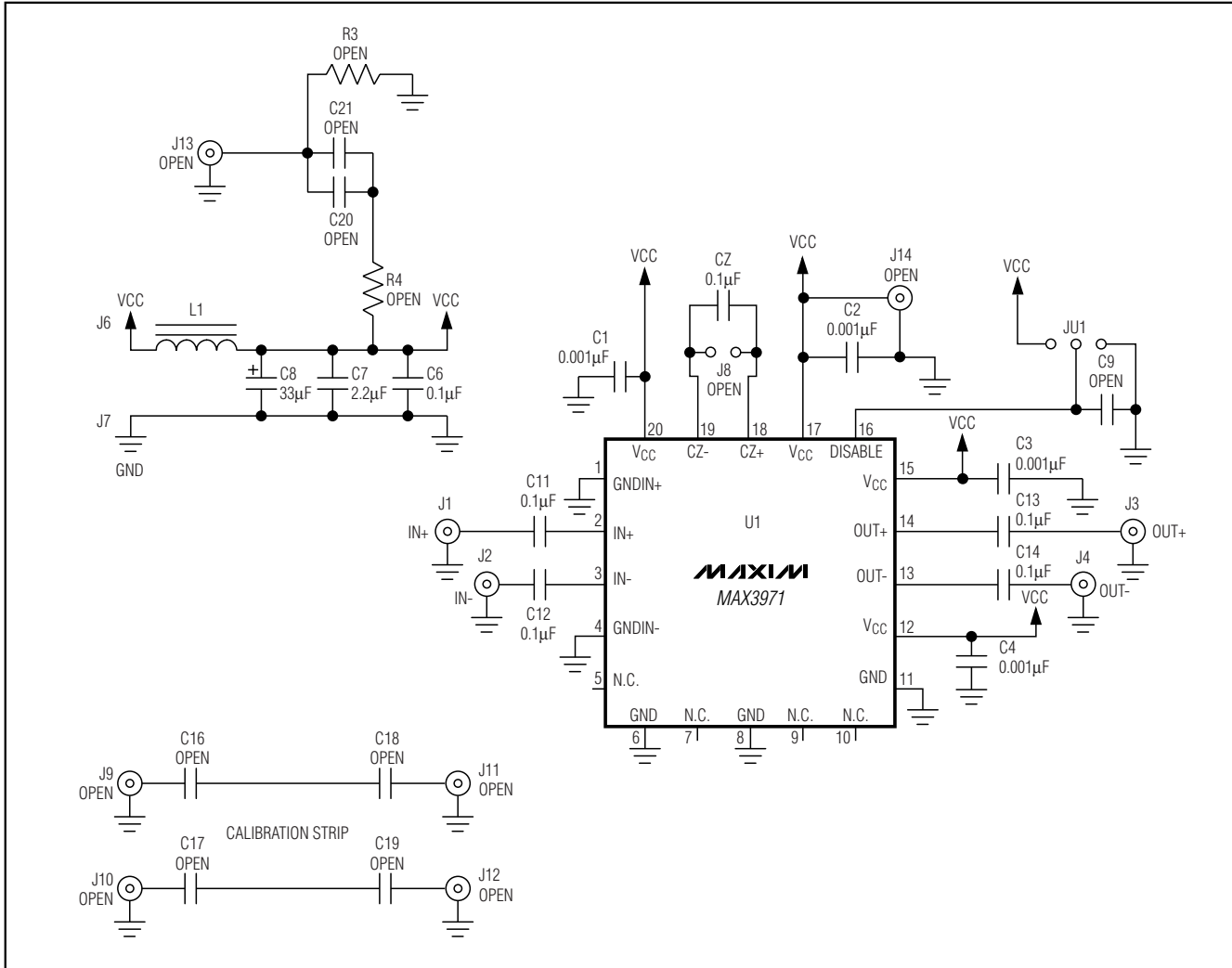

Figure 1. MAX3971 EV Kit Schematic

MAX3971 Evaluation Kit

Evaluates: MAX3971

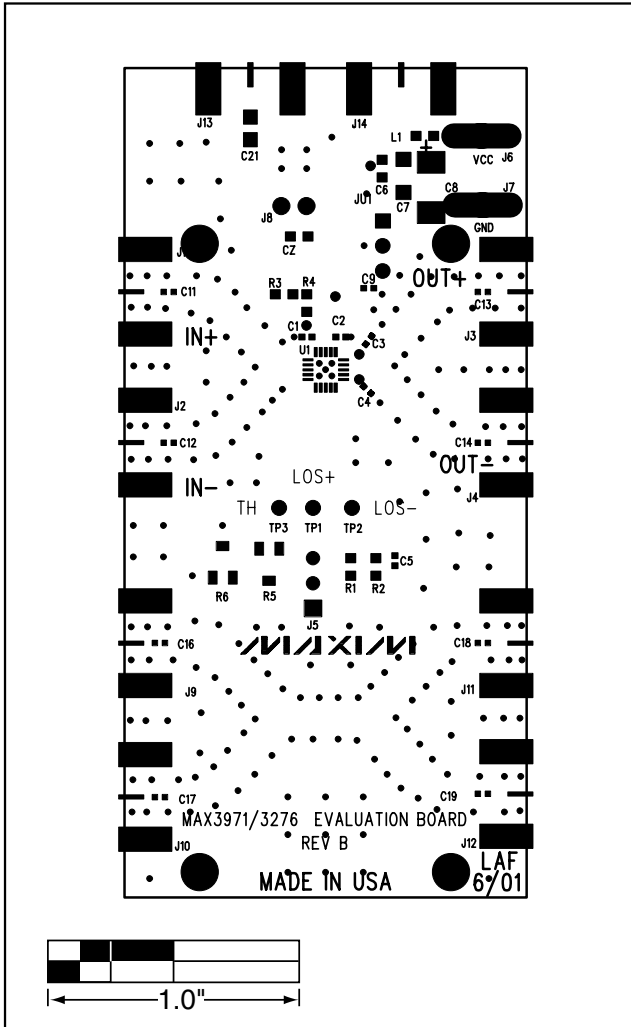

Figure 2. MAX3971 EV Kit Component Placement Guide—Component Side

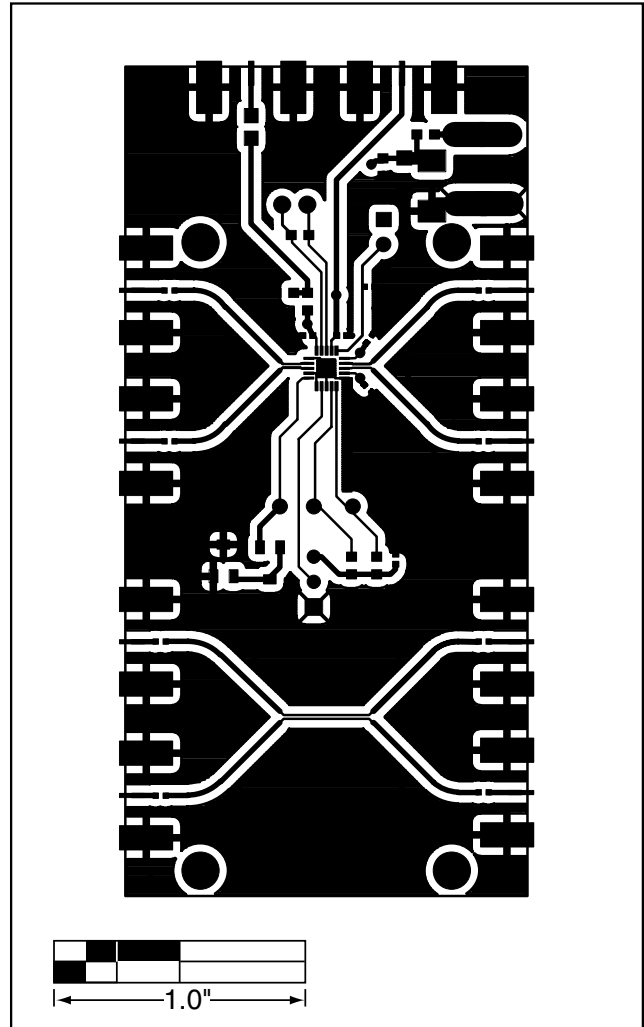

Figure 3. MAX3971 EV Kit PC Board Layout—Component Side

MAX3971 Evaluation Kit

Evaluates: MAX3971

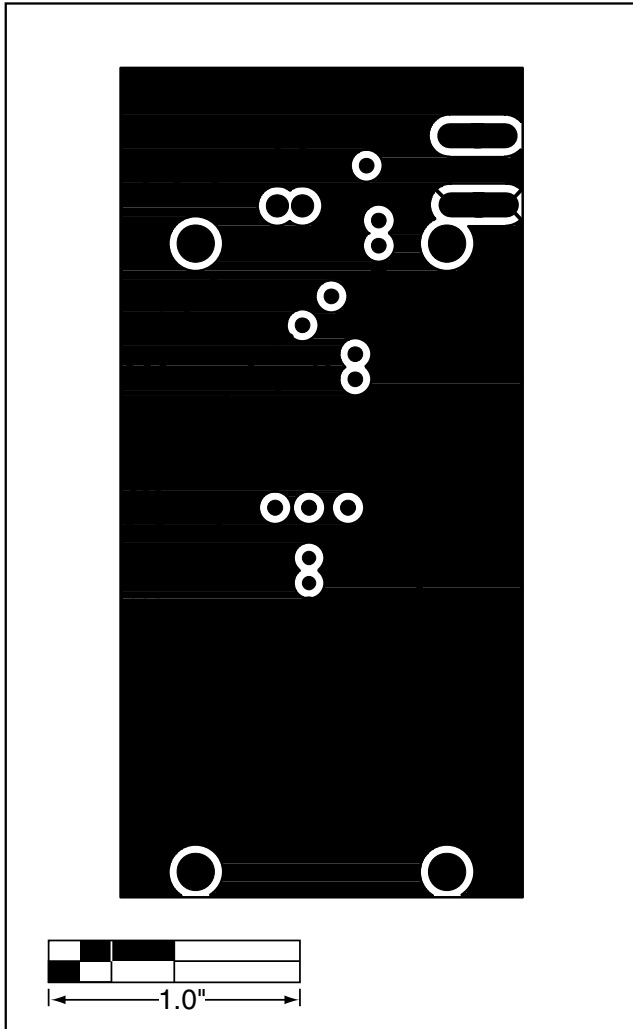

Figure 4. MAX3971 EV Kit PC Board Layout—Ground Plane

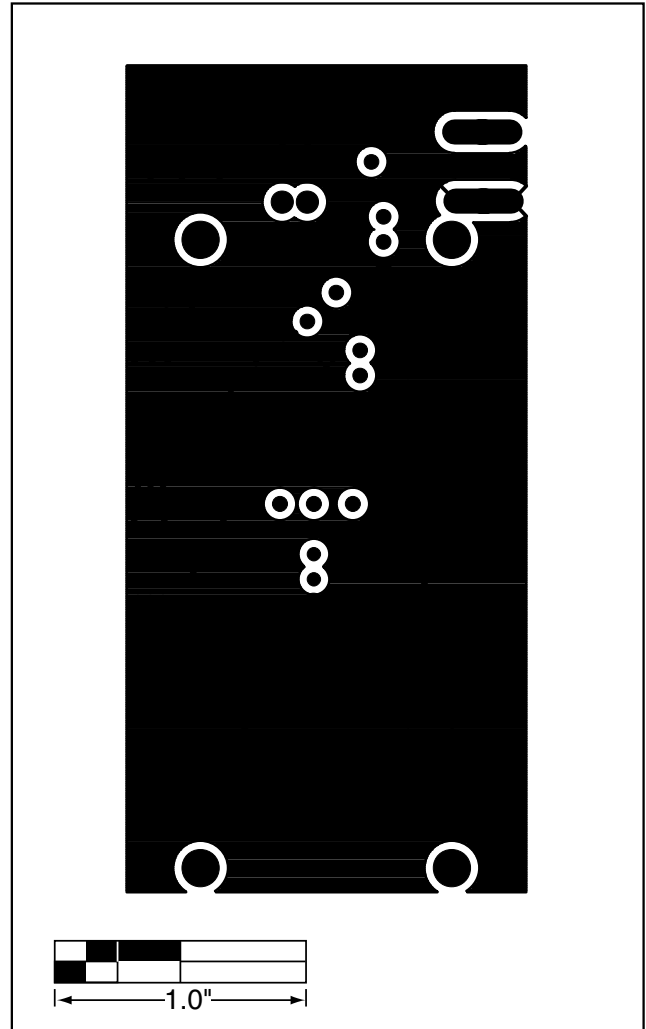

Figure 5. MAX3971 EV Kit PC Board Layout—Power Plane

MAX3971 Evaluation Kit

Evaluates: MAX3971

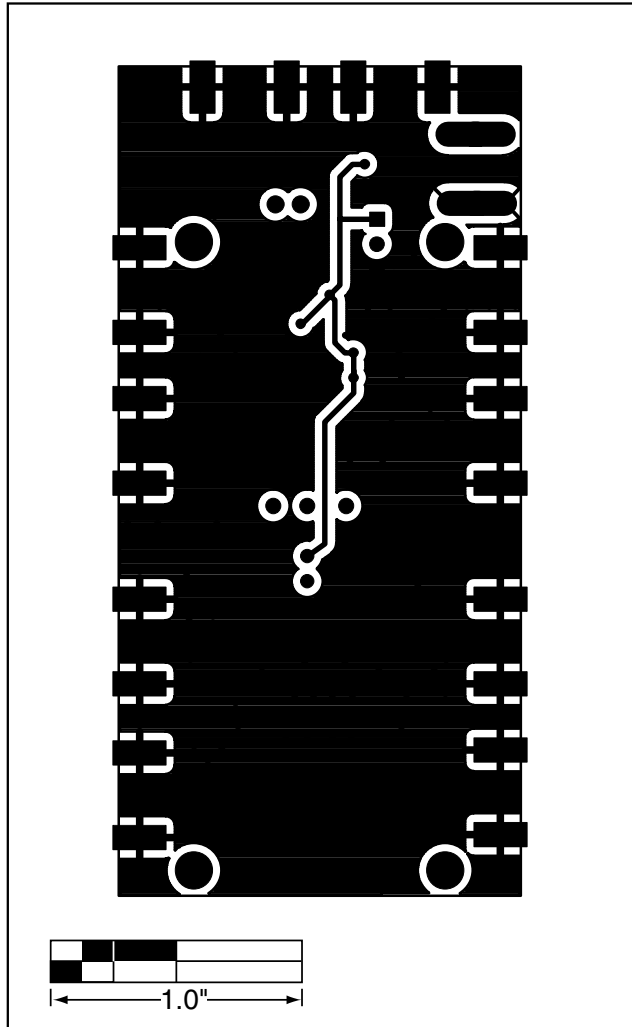

Figure 6. MAX3971 EV Kit PC Board Layout—Solder Side

MAX3971 Evaluation Kit

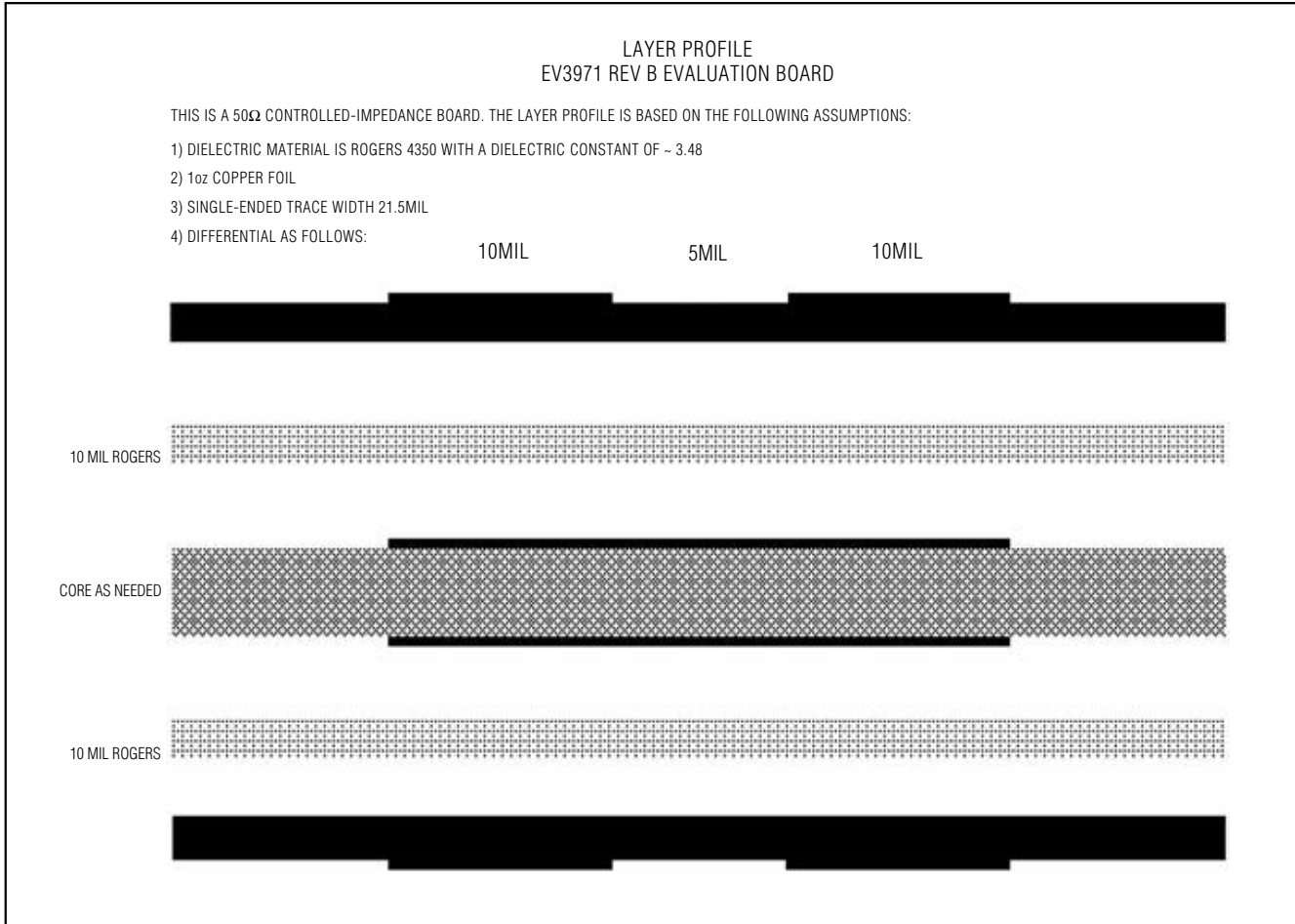

Figure 7. MAX3971 EV Kit PC Board Layer Profile

Maxim cannot assume responsibility for use of any circuitry other than circuitry entirely embodied in a Maxim product. No circuit patent licenses are implied. Maxim reserves the right to change the circuitry and specifications without notice at any time.

6 **Maxim Integrated Products, 120 San Gabriel Drive, Sunnyvale, CA 94086 408-737-7600**