

Low-Power Voltage Output Temperature Sensor

Features

- Tiny Analog Temperature Sensor
- Available Packages: SC70-5
- Wide Temperature Measurement Range:
 - -40°C to +125°C
- Accuracy: $\pm 4^\circ\text{C}$ (max.), 0°C to $+70^\circ\text{C}$
- Optimized for Analog-to-Digital Converters (ADCs):
 - **MCP9700**: 10.0 mV/ $^\circ\text{C}$ (typ.)
 - **MCP9701**: 19.5 mV/ $^\circ\text{C}$ (typ.)
- Wide Operating Voltage Range:
 - **MCP9700**: $V_{DD} = 2.3\text{V}$ to 5.5V
 - **MCP9701**: $V_{DD} = 3.1\text{V}$ to 5.5V
- Low Operating Current: 6 μA (typ.)
- Optimized to Drive Large Capacitive Loads

Typical Applications

- Hard Disk Drives and Other PC Peripherals
- Entertainment Systems
- Home Appliance
- Office Equipment
- Battery Packs and Portable Equipment
- General Purpose Temperature Monitoring

Description

The MCP9700/01 low-cost, low-power and tiny temperature sensor family converts temperature to an analog voltage. It provides an accuracy of $\pm 4^\circ\text{C}$ from 0°C to $+70^\circ\text{C}$ while consuming 6 μA (typ.) of operating current.

The MCP9700/01 provides a low-cost solution for applications that require measurement of a relative change of temperature. When measuring relative change in temperature from 25°C , an accuracy of $\pm 1^\circ\text{C}$ (typ.) can be realized from 0°C to 70°C . This accuracy can also be achieved by applying system calibration at 25°C .

Unlike resistive sensors such as thermistors, this family does not require a signal conditioning circuit. The voltage output pin can be directly connected to an ADC input of a microcontroller. The MCP9700 and MCP9701 temperature coefficients are scaled to provide a 1°C/bit resolution for an 8-bit ADC with a reference voltage of 2.5V and 5V, respectively.

In addition, this family is immune to the effects of parasitic capacitance and can drive large capacitive loads. This provides Printed Circuit Board (PCB) layout design flexibility by enabling the device to be remotely located from the microcontroller. Adding some capacitance at the output also helps the output transient response by reducing overshoots or undershoots. However, capacitive load is not required for sensor output stability.

Package Type

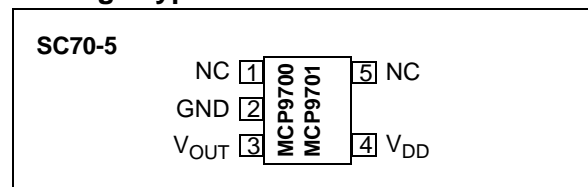

Typical Application Circuit

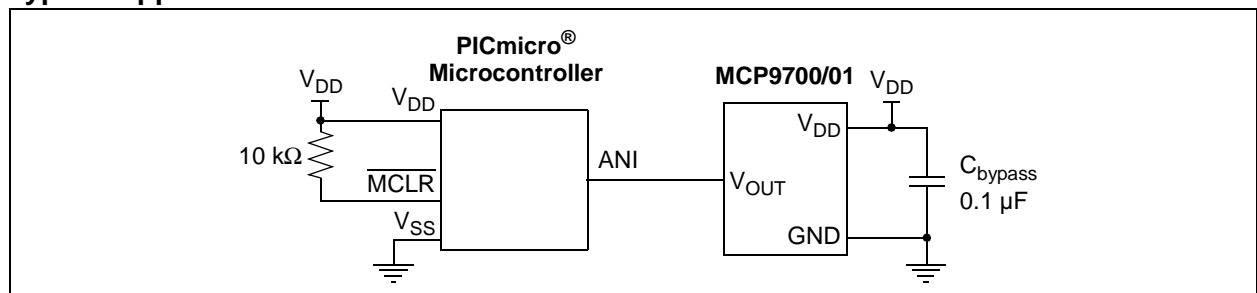

MCP9700/01

1.0 ELECTRICAL CHARACTERISTICS

Absolute Maximum Ratings †

V_{DD} : 6.0V
 Storage temperature: -65°C to +150°C
 Ambient Temp. with Power Applied:.. -40°C to +125°C
 Junction Temperature (T_J):..... 150°C
 ESD Protection On All Pins: (HBM:MM):... (4 kV:200V)
 Latch-Up Current at Each Pin: ±200 mA

†**Notice:** Stresses above those listed under “Maximum Ratings” may cause permanent damage to the device. This is a stress rating only and functional operation of the device at those or any other conditions above those indicated in the operational listings of this specification is not implied. Exposure to maximum rating conditions for extended periods may affect device reliability.

Pin Function

NAME	FUNCTION
NC	Not Connected
V_{OUT}	Voltage Output
V_{DD}	Power Supply
GND	Ground

DC ELECTRICAL CHARACTERISTICS

Electrical Specifications: Unless otherwise indicated:						
MCP9700: V_{DD} = 2.3V to 5.5V, GND = Ground, T_A = -40°C to +125°C and No load.						
MCP9701: V_{DD} = 3.1V to 5.5V, GND = Ground, T_A = -10°C to +125°C and No load.						
Parameter	Sym	Min	Typ	Max	Unit	Conditions
Power Supply						
Operating Voltage Range	V_{DD}	2.3	—	5.5	V	MCP9700
	V_{DD}	3.1	—	5.5	V	MCP9701
Operating Current	I_{DD}	—	6	12	µA	
Power Supply Rejection	PSR	—	0.1	—	°C/V	MCP9700 V_{DD} = 2.3V - 4.0V MCP9701 V_{DD} = 3.1V - 4.0V
Sensor Accuracy (Notes 1, 2)						
T_A = +25°C	T_{ACY}	—	±1	—	°C	MCP9700 MCP9701
T_A = 0°C to +70°C	T_{ACY}	-4.0	—	+4.0	°C	
T_A = -40°C to +125°C	T_{ACY}	-4.0	—	+6.0	°C	
T_A = -10°C to +125°C	T_{ACY}	-4.0	—	+6.0	°C	
Sensor Output						
Output Voltage: T_A = 0°C	$V_{0°C}$	—	500	—	mV	MCP9700
	$V_{0°C}$	—	400	—	mV	MCP9701
Temperature Coefficient	T_{C1}	—	10.0	—	mV/°C	MCP9700
	T_{C1}	—	19.5	—	mV/°C	MCP9701
Output Non-linearity	V_{ONL}	—	±0.5	—	°C	T_A = 0°C to +70°C (Note 2)
Output Current	I_{OUT}	—	—	100	µA	
Output Impedance	Z_{OUT}	—	20	—	Ω	I_{OUT} = 100 µA, f = 500 Hz
Output Load Regulation	$\Delta V_{OUT}/\Delta I_{OUT}$	—	1	—	Ω	T_A = 0°C to +70°C, I_{OUT} = 100 µA
Turn-on Time	t_{ON}	—	800	—	µs	
Typical Load Capacitance (Note 3)	C_{LOAD}	—	—	1000	pF	
Thermal Response to 63%	t_{RES}	—	1.3	—	s	30°C (air) to +125°C (fluid bath) (Note 4)

- Note 1:** The MCP9700 accuracy is tested with V_{DD} = 3.3V, while the MCP9701 accuracy is tested with V_{DD} = 5.0V.
Note 2: The MCP9700/01 is characterized using the first-order or linear equation, as shown in Equation 3-1.
Note 3: The MCP9700/01 family is characterized and production-tested with a capacitive load of 1000 pF.
Note 4: Thermal response with 1 x 1 inch dual-sided copper clad.

TEMPERATURE CHARACTERISTICS

Electrical Specifications: Unless otherwise indicated, MCP9700: $V_{DD} = 2.3V$ to $5.5V$, GND = Ground, $T_A = -40^{\circ}C$ to $+125^{\circ}C$ and No load. MCP9701: $V_{DD} = 3.1V$ to $5.5V$, GND = Ground, $T_A = -10^{\circ}C$ to $+125^{\circ}C$ and No load.						
Parameters	Sym	Min	Typ	Max	Units	Conditions
Temperature Ranges						
Specified Temperature Range	T_A	-40	—	+125	$^{\circ}C$	MCP9700 (Note 1)
	T_A	-10	—	+125	$^{\circ}C$	MCP9701 (Note 1)
Operating Temperature Range	T_A	-40	—	+125	$^{\circ}C$	
Storage Temperature Range	T_A	-65	—	+150	$^{\circ}C$	
Thermal Package Resistances						
Thermal Resistance, 5L-SC70	θ_{JA}	—	331	—	$^{\circ}C/W$	

Note 1: Operation in this range must not cause T_J to exceed Maximum Junction Temperature ($+150^{\circ}C$).

MCP9700/01

2.0 TYPICAL PERFORMANCE CURVES

Note: The graphs and tables provided following this note are a statistical summary based on a limited number of samples and are provided for informational purposes only. The performance characteristics listed herein are not tested or guaranteed. In some graphs or tables, the data presented may be outside the specified operating range (e.g., outside specified power supply range) and therefore outside the warranted range.

Note: Unless otherwise indicated, **MCP9700:** $V_{DD} = 2.3V$ to $5.5V$; **MCP9701:** $V_{DD} = 3.1V$ to $5.5V$; GND = Ground, $C_{bypass} = 0.1 \mu F$.

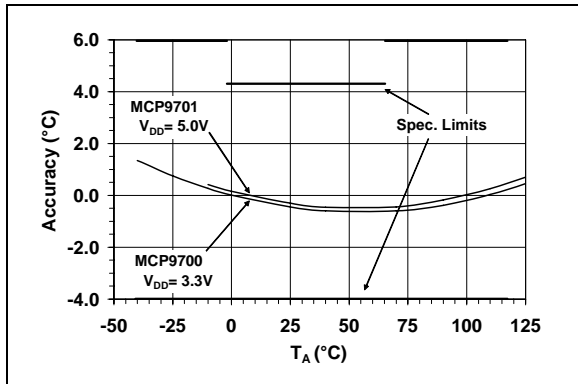

FIGURE 2-1: Accuracy vs. Ambient Temperature.

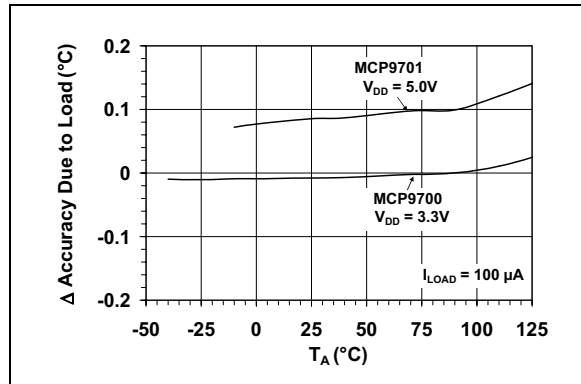

FIGURE 2-4: Changes in Accuracy Due to Load vs. Ambient Temperature (Due to Load).

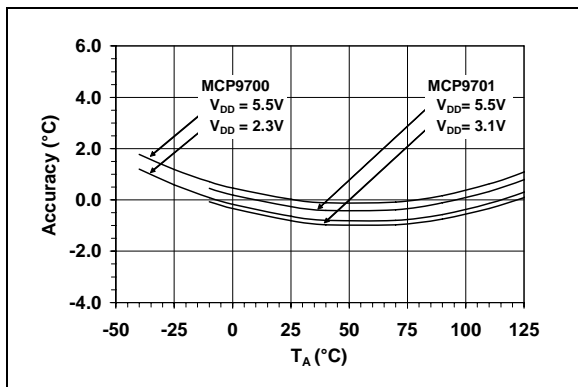

FIGURE 2-2: Accuracy vs. Ambient Temperature, with V_{DD} .

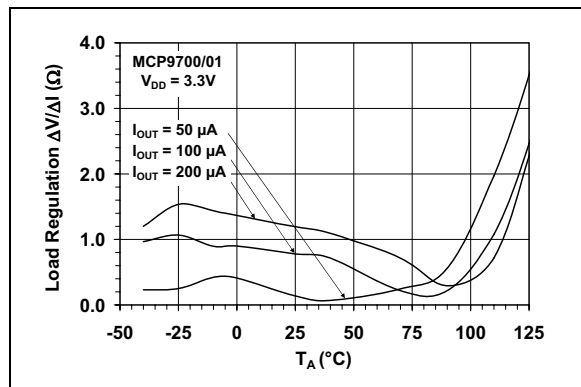

FIGURE 2-5: Load Regulation vs. Ambient Temperature.

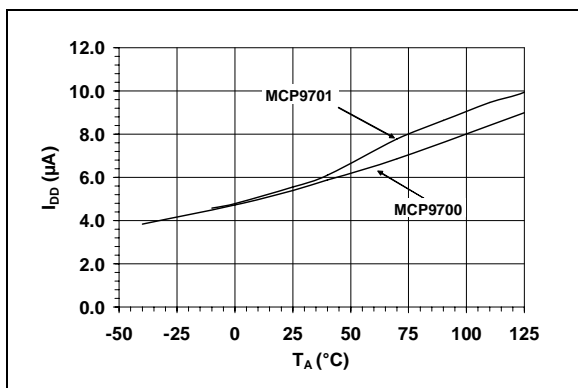

FIGURE 2-3: Supply Current vs. Temperature.

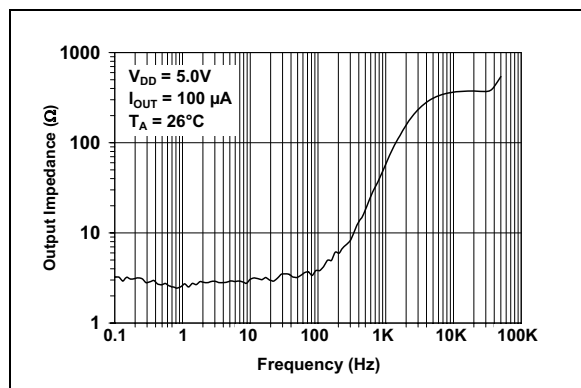

FIGURE 2-6: Output Impedance vs. Frequency.

Note: Unless otherwise indicated, **MCP9700:** $V_{DD} = 2.3V$ to $5.5V$; **MCP9701:** $V_{DD} = 3.1V$ to $5.5V$; GND = Ground, $C_{bypass} = 0.1 \mu F$.

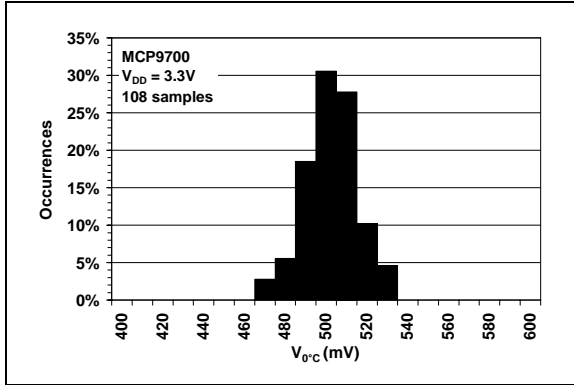

FIGURE 2-7: Output Voltage at $0^{\circ}C$ (MCP9700).

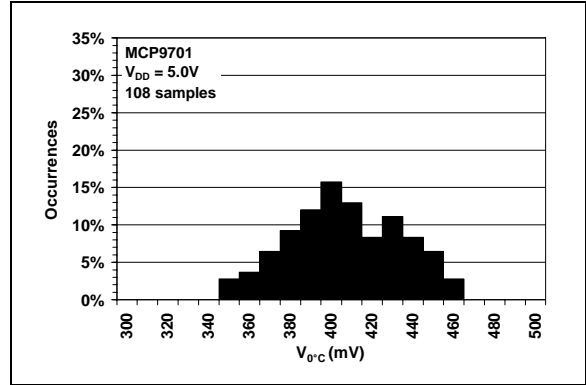

FIGURE 2-10: Occurrences vs. Temperature Coefficient (MCP9701).

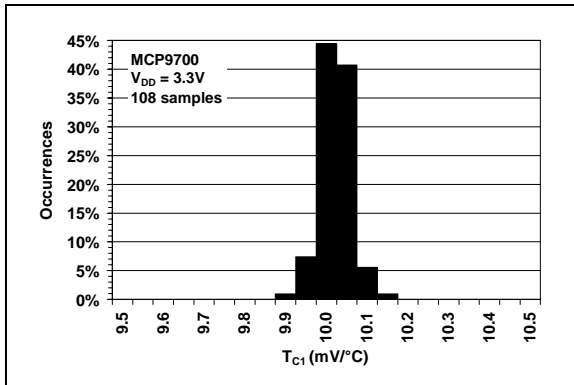

FIGURE 2-8: Occurrences vs. First-Order Temperature Coefficient (MCP9700).

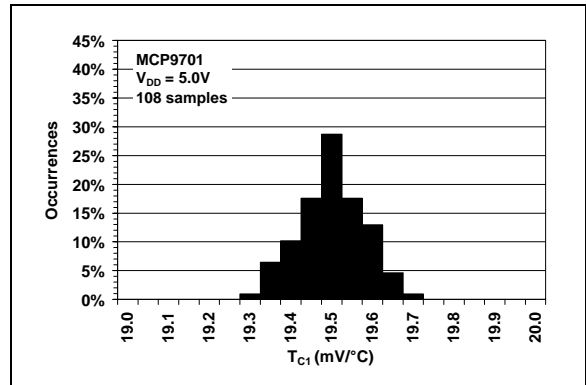

FIGURE 2-11: Occurrences vs. First-Order Temperature Coefficient (MCP9701).

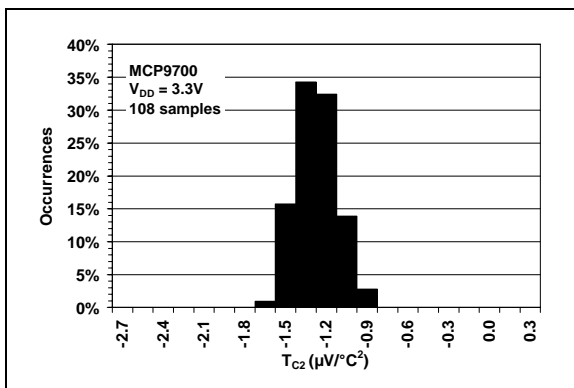

FIGURE 2-9: Occurrences vs. Second-Order Temperature Coefficient (MCP9700).

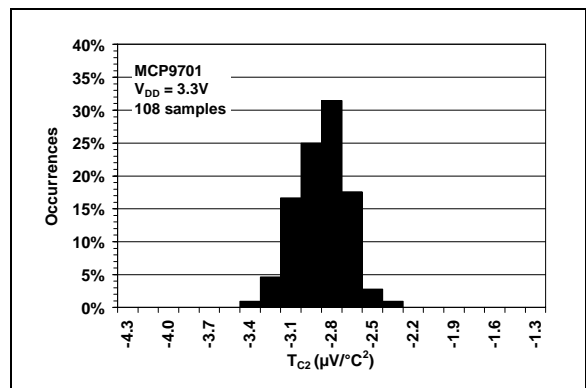

FIGURE 2-12: Occurrences vs. Second-Order Temperature Coefficient (MCP9701).

MCP9700/01

Note: Unless otherwise indicated, **MCP9700:** $V_{DD} = 2.3V$ to $5.5V$; **MCP9701:** $V_{DD} = 3.1V$ to $5.5V$; GND = Ground, $C_{bypass} = 0.1 \mu F$.

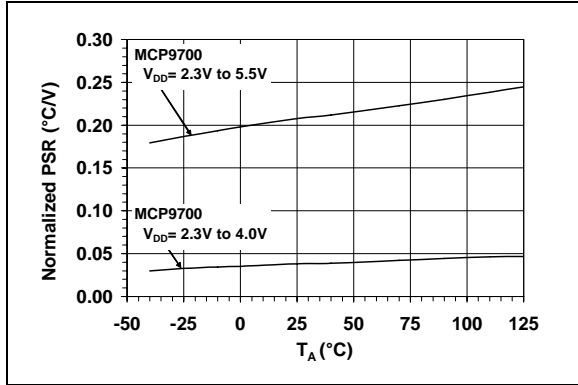

FIGURE 2-13: Power Supply Rejection (PSR) vs. Ambient Temperature.

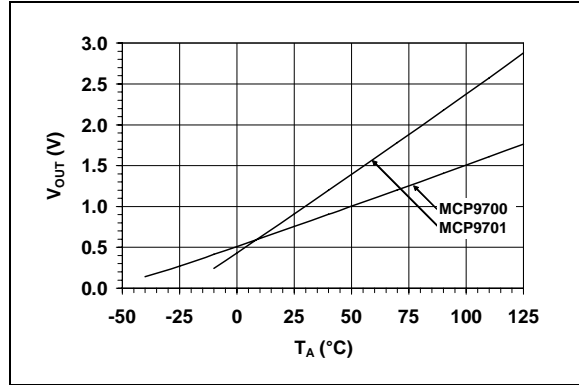

FIGURE 2-16: Output Voltage vs. Ambient Temperature.

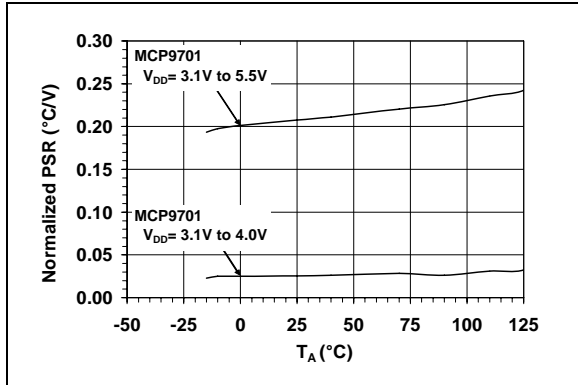

FIGURE 2-14: Power Supply Rejection (PSR) vs. Frequency.

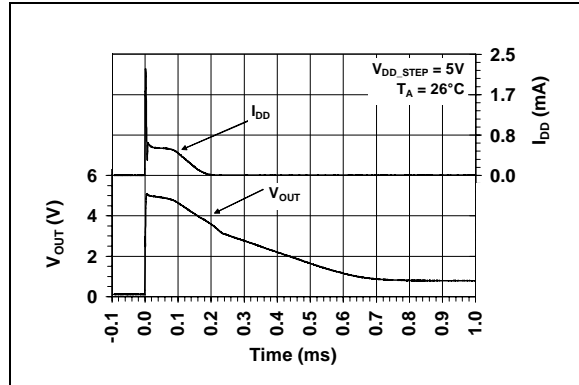

FIGURE 2-17: Output vs. Time.

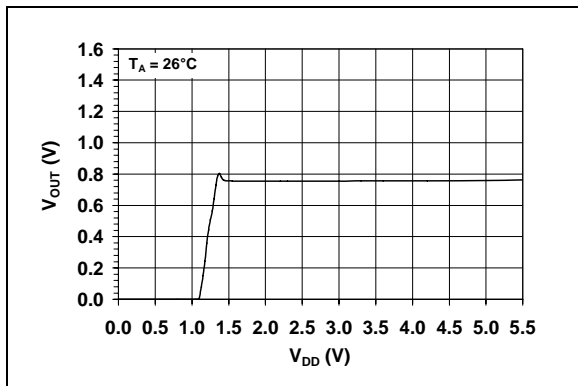

FIGURE 2-15: Output Voltage vs. Power Supply.

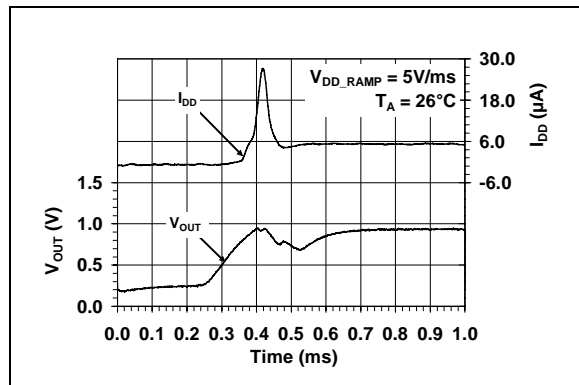

FIGURE 2-18: Output vs. Time

Note: Unless otherwise indicated, **MCP9700:** $V_{DD} = 2.3V$ to $5.5V$; **MCP9701:** $V_{DD} = 3.1V$ to $5.5V$; GND = Ground, $C_{bypass} = 0.1 \mu F$.

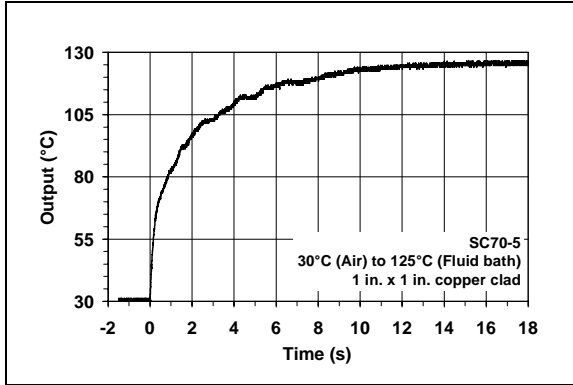

FIGURE 2-19: Thermal Response.

MCP9700/01

3.0 FUNCTIONAL DESCRIPTION

The MCP9700/01 temperature sensing element is essentially a P-N junction or a diode. The diode electrical characteristics has a temperature coefficient that provides a change in voltage based on the relative ambient temperature from -40°C to 125°C. The change in voltage is scaled to a temperature coefficient of 10.0 mV/°C (typ.) for the MCP9700 and 19.5 mV/°C (typ.) for the MCP9701. The output voltage at 0°C is also scaled to 500 mV (typ.) and 400 mV (typ.) for the MCP9700 and MCP9701, respectively. This linear scale is described in the transfer function shown in Equation 3-1.

EQUATION 3-1: SENSOR TRANSFER FUNCTION

$$V_{OUT} = T_{C1} \cdot T_A + V_{0^\circ C}$$

Where:

T_A = Ambient Temperature

V_{OUT} = Sensor Output Voltage

$V_{0^\circ C}$ = Sensor Output Voltage at 0°C

T_{C1} = Temperature Coefficient

4.0 APPLICATIONS INFORMATION

4.1 Improving Accuracy

The MCP9700/01 accuracy can be improved by performing a system calibration at a specific temperature. For example, calibrating the system at 25°C ambient improves the measurement accuracy to a ±0.5°C (typ.) from 0°C to 70°C, as shown in Figure 4-1. Therefore, when measuring relative temperature change, this family measures temperature with higher accuracy.

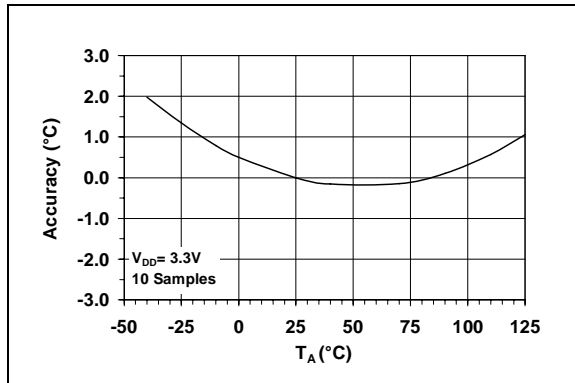

FIGURE 4-1: Relative Accuracy to +25°C vs. Temperature.

The relative change in accuracy from the calibration temperature is due to the output non-linearity from the first-order equation, specified in Equation 3-1. The accuracy can be further improved by compensating for the output non-linearity.

For higher accuracy, the sensor output transfer function is also derived using a second-order equation as shown in Equation 4-1. The equation describes the output non-linearity. This equation is not used to characterize the part as specified in the DC Electrical Characteristics table; however, it provides better accuracy.

EQUATION 4-1: SECOND-ORDER TRANSFER FUNCTION

$$V_{OUT} = T_{C2} (T_A + 10^\circ\text{C})(125^\circ\text{C} - T_A) + T_{C1} T_A + V_{0^\circ\text{C}}$$

$$= -T_{C2} T_A^2 + (T_{C1} + 115 T_{C2})T_A + 1250 T_{C2} + V_{0^\circ\text{C}}$$

Where:

- T_A = Ambient Temperature
- V_{OUT} = Sensor Output Voltage
- $V_{0^\circ\text{C}}$ = Sensor Output Voltage at 0°C
(refer to Figure 2-7 and 2-10)
- T_{C1} = Temperature Coefficient
(refer to Figure 2-8 and 2-11)
- T_{C2} = Temperature Coefficient
MCP9700 1.4 $\mu\text{V}/^\circ\text{C}^2$ (typ.)
MCP9701 2.7 $\mu\text{V}/^\circ\text{C}^2$ (typ.)
(refer to Figure 2-9 and 2-12)

4.2 Shutdown Using Microcontroller I/O Pin

The MCP9700/01 low operating current of 6 μA (typ.) makes it ideal for battery-powered applications. However, for applications that require tighter current budget, this device can be powered using a microcontroller Input/Output (I/O) pin. The I/O pin can be toggled to shutdown the device. In such applications, the microcontroller internal digital switching noise is emitted to the MCP9700/01 as power supply noise. This switching noise compromises measurement accuracy. Therefore, a decoupling capacitor will be necessary.

4.3 Layout Considerations

The MCP9700/01 does not require any additional components to operate. However, it is recommended that a decoupling capacitor of 0.1 μF to 1 μF be used between the V_{DD} and GND pins. In high-noise applications, connect the power supply voltage to the V_{DD} pin using a 200 Ω resistor with a 1 μF decoupling capacitor. A high-frequency ceramic capacitor is recommended. It is necessary for the capacitor to be located as close as possible to the V_{DD} and GND pins in order to provide effective noise protection. In addition, avoid tracing digital lines in close proximity to the sensor.

MCP9700/01

4.4 Thermal Considerations

The MCP9700/01 measures temperature by monitoring the voltage of a diode located in the die. A low impedance thermal path between the die and the PCB is provided by the pins. Therefore, the MCP9700/01 effectively monitors the temperature of the PCB. However, the thermal path for the ambient air is not as efficient because the plastic device package functions as a thermal insulator from the die. This limitation applies to plastic-packaged silicon temperature sensors. If the application requires measuring ambient air, the PCB needs to be designed with proper thermal conduction to the sensor pins.

The MCP9700/01 is designed to source/sink 100 μA (max.). The power dissipation due to the output current is relatively insignificant. The effect of the output current can be described using Equation 4-2.

EQUATION 4-2: EFFECT OF SELF-HEATING

$$T_J - T_A = \theta_{JA}(V_{DD}I_{DD} + (V_{DD} - V_{OUT})I_{OUT})$$

Where:

T_J = Junction Temperature
 T_A = Ambient Temperature
 θ_{JA} = Package Thermal Resistance (331°C/W)
 V_{OUT} = Sensor Output Voltage
 I_{OUT} = Sensor Output Current
 I_{DD} = Operating Current
 V_{DD} = Operating Voltage

At $T_A = +25^\circ\text{C}$ ($V_{OUT} = 0.75\text{V}$) and maximum specification of $I_{DD} = 12 \mu\text{A}$, $V_{DD} = 5.5\text{V}$ and $I_{OUT} = +100 \mu\text{A}$, the self-heating due to power dissipation ($T_J - T_A$) is 0.179°C.

5.0 PACKAGING INFORMATION

5.1 Package Marking Information

5-Lead SC-70 (MCP9700)

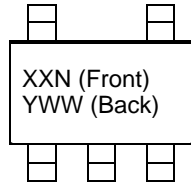

Device	Code
MCP9700	AUN
MCP9701	AVN

Note: Applies to 5-Lead SC-70.

Example:

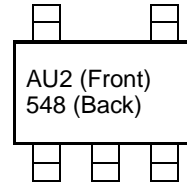

5-Lead SC-70 (MCP9701)

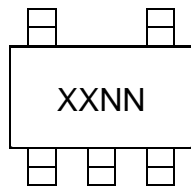

Device	Code
MCP9700	AUNN
MCP9701	AVNN

Note: Applies to 5-Lead SC-70.

Example:

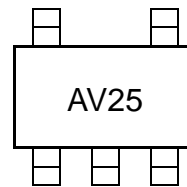

Legend:	XX...X	Customer-specific information
	Y	Year code (last digit of calendar year)
	YY	Year code (last 2 digits of calendar year)
	WW	Week code (week of January 1 is week '01')
	NNN	Alphanumeric traceability code
	(e3)	Pb-free JEDEC designator for Matte Tin (Sn)
	*	This package is Pb-free. The Pb-free JEDEC designator (e3) can be found on the outer packaging for this package.

Note: In the event the full Microchip part number cannot be marked on one line, it will be carried over to the next line, thus limiting the number of available characters for customer-specific information.

MCP9700/01

5-Lead Plastic Small Outline Transistor (LT) (SC-70)

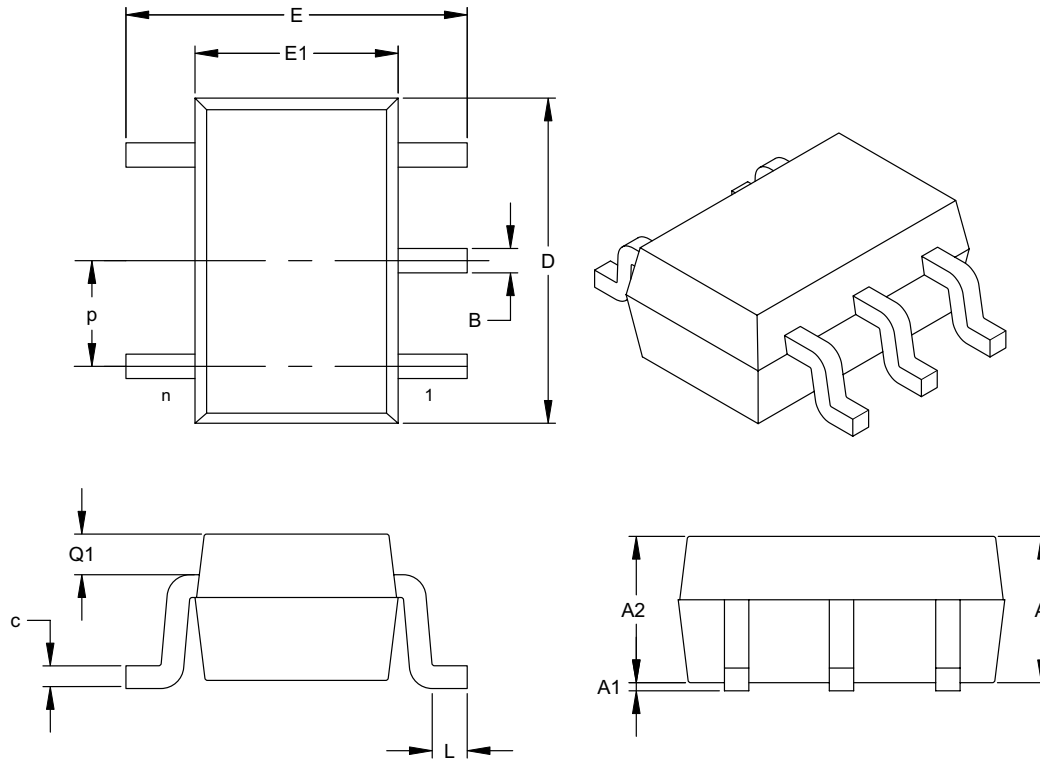

Dimension Limits	Units	INCHES			MILLIMETERS*		
		MIN	NOM	MAX	MIN	NOM	MAX
Number of Pins	n	5			5		
Pitch	p	.026 (BSC)			0.65 (BSC)		
Overall Height	A	.031		.043	0.80		1.10
Molded Package Thickness	A2	.031		.039	0.80		1.00
Standoff	A1	.000		.004	0.00		0.10
Overall Width	E	.071		.094	1.80		2.40
Molded Package Width	E1	.045		.053	1.15		1.35
Overall Length	D	.071		.087	1.80		2.20
Foot Length	L	.004		.012	0.10		0.30
Top of Molded Pkg to Lead Shoulder	Q1	.004		.016	0.10		0.40
Lead Thickness	c	.004		.007	0.10		0.18
Lead Width	B	.006		.012	0.15		0.30

*Controlling Parameter

Notes:

Dimensions D and E1 do not include mold flash or protrusions. Mold flash or protrusions shall not exceed .005" (0.127mm) per side.

JEITA (EIAJ) Standard: SC-70

Drawing No. C04-061

APPENDIX A: REVISION HISTORY

Revision A (March 2005)

- Original Release of this Document.

MCP9700/01

NOTES:

PRODUCT IDENTIFICATION SYSTEM

To order or obtain information, e.g., on pricing or delivery, refer to the factory or the listed sales office.

<u>PART NO.</u>	-	<u>X</u>	<u>/XX</u>
Device		Temperature Range	Package
Device:		MCP9700T: Tiny Analog Temperature Sensor, Tape and Reel, Pb free MCP9701T: Tiny Analog Temperature Sensor, Tape and Reel, Pb free	
Temperature Range:		E = -40°C to +125°C	
Package:		LT = Plastic Small Outline Transistor, 5-lead	

Examples:

- a) MCP9700T-E/LT: Tiny Analog Temperature Sensor, Tape and Reel, -40°C to +125°C, 5LD SC70 package.
- a) MCP9701T-E/LT: Tiny Analog Temperature Sensor, Tape and Reel, -40°C to +125°C, 5LD SC70 package.

MCP9700/01

NOTES:

Note the following details of the code protection feature on Microchip devices:

- Microchip products meet the specification contained in their particular Microchip Data Sheet.
- Microchip believes that its family of products is one of the most secure families of its kind on the market today, when used in the intended manner and under normal conditions.
- There are dishonest and possibly illegal methods used to breach the code protection feature. All of these methods, to our knowledge, require using the Microchip products in a manner outside the operating specifications contained in Microchip's Data Sheets. Most likely, the person doing so is engaged in theft of intellectual property.
- Microchip is willing to work with the customer who is concerned about the integrity of their code.
- Neither Microchip nor any other semiconductor manufacturer can guarantee the security of their code. Code protection does not mean that we are guaranteeing the product as "unbreakable."

Code protection is constantly evolving. We at Microchip are committed to continuously improving the code protection features of our products. Attempts to break Microchip's code protection feature may be a violation of the Digital Millennium Copyright Act. If such acts allow unauthorized access to your software or other copyrighted work, you may have a right to sue for relief under that Act.

Information contained in this publication regarding device applications and the like is provided only for your convenience and may be superseded by updates. It is your responsibility to ensure that your application meets with your specifications. MICROCHIP MAKES NO REPRESENTATIONS OR WARRANTIES OF ANY KIND WHETHER EXPRESS OR IMPLIED, WRITTEN OR ORAL, STATUTORY OR OTHERWISE, RELATED TO THE INFORMATION, INCLUDING BUT NOT LIMITED TO ITS CONDITION, QUALITY, PERFORMANCE, MERCHANTABILITY OR FITNESS FOR PURPOSE. Microchip disclaims all liability arising from this information and its use. Use of Microchip's products as critical components in life support systems is not authorized except with express written approval by Microchip. No licenses are conveyed, implicitly or otherwise, under any Microchip intellectual property rights.

Trademarks

The Microchip name and logo, the Microchip logo, Accuron, dsPIC, KEELOQ, microID, MPLAB, PIC, PICmicro, PICSTART, PRO MATE, PowerSmart, rPIC, and SmartShunt are registered trademarks of Microchip Technology Incorporated in the U.S.A. and other countries.

AmpLab, FilterLab, Migratable Memory, MXDEV, MXLAB, PICMASTER, SEEVAL, SmartSensor and The Embedded Control Solutions Company are registered trademarks of Microchip Technology Incorporated in the U.S.A.

Analog-for-the-Digital Age, Application Maestro, dsPICDEM, dsPICDEM.net, dsPICworks, ECAN, ECONOMONITOR, FanSense, FlexROM, fuzzyLAB, In-Circuit Serial Programming, ICSP, ICEPIC, MPASM, MPLIB, MPLINK, MPSIM, PICkit, PICDEM, PICDEM.net, PICLAB, PICtail, PowerCal, PowerInfo, PowerMate, PowerTool, rLAB, rPICDEM, Select Mode, Smart Serial, SmartTel, Total Endurance and WiperLock are trademarks of Microchip Technology Incorporated in the U.S.A. and other countries.

SQTP is a service mark of Microchip Technology Incorporated in the U.S.A.

All other trademarks mentioned herein are property of their respective companies.

© 2005, Microchip Technology Incorporated, Printed in the U.S.A., All Rights Reserved.

 Printed on recycled paper.

**QUALITY MANAGEMENT SYSTEM
CERTIFIED BY DNV
== ISO/TS 16949:2002 ==**

Microchip received ISO/TS-16949:2002 quality system certification for its worldwide headquarters, design and wafer fabrication facilities in Chandler and Tempe, Arizona and Mountain View, California in October 2003. The Company's quality system processes and procedures are for its PICmicro® 8-bit MCUs, KEELOQ® code hopping devices, Serial EEPROMs, microperipherals, nonvolatile memory and analog products. In addition, Microchip's quality system for the design and manufacture of development systems is ISO 9001:2000 certified.



WORLDWIDE SALES AND SERVICE

AMERICAS

Corporate Office
2355 West Chandler Blvd.
Chandler, AZ 85224-6199
Tel: 480-792-7200
Fax: 480-792-7277
Technical Support:
<http://support.microchip.com>
Web Address:
www.microchip.com

Atlanta
Alpharetta, GA
Tel: 770-640-0034
Fax: 770-640-0307

Boston
Westborough, MA
Tel: 774-760-0087
Fax: 774-760-0088

Chicago
Itasca, IL
Tel: 630-285-0071
Fax: 630-285-0075

Dallas
Addison, TX
Tel: 972-818-7423
Fax: 972-818-2924

Detroit
Farmington Hills, MI
Tel: 248-538-2250
Fax: 248-538-2260

Kokomo
Kokomo, IN
Tel: 765-864-8360
Fax: 765-864-8387

Los Angeles
Mission Viejo, CA
Tel: 949-462-9523
Fax: 949-462-9608

San Jose
Mountain View, CA
Tel: 650-215-1444
Fax: 650-961-0286

Toronto
Mississauga, Ontario,
Canada
Tel: 905-673-0699
Fax: 905-673-6509

ASIA/PACIFIC

Australia - Sydney
Tel: 61-2-9868-6733
Fax: 61-2-9868-6755

China - Beijing
Tel: 86-10-8528-2100
Fax: 86-10-8528-2104

China - Chengdu
Tel: 86-28-8676-6200
Fax: 86-28-8676-6599

China - Fuzhou
Tel: 86-591-8750-3506
Fax: 86-591-8750-3521

China - Hong Kong SAR
Tel: 852-2401-1200
Fax: 852-2401-3431

China - Shanghai
Tel: 86-21-5407-5533
Fax: 86-21-5407-5066

China - Shenyang
Tel: 86-24-2334-2829
Fax: 86-24-2334-2393

China - Shenzhen
Tel: 86-755-8203-2660
Fax: 86-755-8203-1760

China - Shunde
Tel: 86-757-2839-5507
Fax: 86-757-2839-5571

China - Qingdao
Tel: 86-532-502-7355
Fax: 86-532-502-7205

ASIA/PACIFIC

India - Bangalore
Tel: 91-80-2229-0061
Fax: 91-80-2229-0062

India - New Delhi
Tel: 91-11-5160-8631
Fax: 91-11-5160-8632

Japan - Kanagawa
Tel: 81-45-471- 6166
Fax: 81-45-471-6122

Korea - Seoul
Tel: 82-2-554-7200
Fax: 82-2-558-5932 or
82-2-558-5934

Singapore
Tel: 65-6334-8870
Fax: 65-6334-8850

Taiwan - Kaohsiung
Tel: 886-7-536-4818
Fax: 886-7-536-4803

Taiwan - Taipei
Tel: 886-2-2500-6610
Fax: 886-2-2508-0102

Taiwan - Hsinchu
Tel: 886-3-572-9526
Fax: 886-3-572-6459

EUROPE

Austria - Weis
Tel: 43-7242-2244-399
Fax: 43-7242-2244-393

Denmark - Ballerup
Tel: 45-4450-2828
Fax: 45-4485-2829

France - Massy
Tel: 33-1-69-53-63-20
Fax: 33-1-69-30-90-79

Germany - Ismaning
Tel: 49-89-627-144-0
Fax: 49-89-627-144-44

Italy - Milan
Tel: 39-0331-742611
Fax: 39-0331-466781

Netherlands - Drunen
Tel: 31-416-690399
Fax: 31-416-690340

England - Berkshire
Tel: 44-118-921-5869
Fax: 44-118-921-5820