



# MAX3983 SMA Connector Evaluation Kit

## General Description

The MAX3983 SMA Connector evaluation kit (EV Kit) is an assembled demonstration board that provides electrical evaluation of the MAX3983 Quad Copper Cable Signal Conditioner. All data inputs and outputs are accessible through SMA connectors. The EV Kit also includes a calibration strip for accurate measurements.

## Component List

DESIGNATION	QTY	DESCRIPTION
C1-C32, C35-C44	42	0.01 $\mu$ F $\pm$ 5% ceramic capacitors (0402)
C33	1	33 $\mu$ F tantalum capacitor
C34, C45, C46, C49	4	0.1 $\mu$ F $\pm$ 5% ceramic capacitors (0402)
C47, C48, C50, C51	4	Not Installed
J1-J34	34	SMA connectors, edge mount
JP1, JP2, JP8 - JP10, JP12	6	2-pin headers, 0.1in centers
JP3	1	3-pin header, 0.1in centers
JP5	1	3-pin + 1-pin header, 0.1in centers
JP11	1	Not Installed
L1	1	4.7 $\mu$ H Inductor Coilcraft DS1608C-472
R1-R8	8	4.7k $\Omega$ $\pm$ 5% resistors (0402)
R10 - R18	9	Not Installed
TP1-TP11	11	Test points Digi-Key 5000K-ND
U1	1	MAX3983UGK 68-QFN*
U2	1	OR Gate Fairchild NC7S32P5X SC70
None		MAX3983 SMA connector evaluation circuit board, rev B
None		MAX3983 data sheet

**\*Note:** U1 has an exposed pad which requires it to be solder attached to the circuit board to ensure proper functionality of the part.

## Features

- ◆ Fully Assembled and Tested
- ◆ Easy Selection of Operating Modes
- ◆ Equipped with SMA Connectors on all Data Inputs and Outputs

## Ordering Information

PART	TEMP. RANGE	IC PACKAGE
MAX3983SMAEVKIT	0°C to +85°C	68 QFN

## Component Suppliers

SUPPLIER	PHONE	FAX
AVX	843-448-9411	843-448-1943
Coilcraft	847-639-6400	847-639-1469
Digi-Key	218-681-6674	218-681-3380
Murata	770-436-1300	770-436-3030

**Note:** Please indicate that you are using the MAX3983 when ordering from these suppliers.

## Quick Start





- 1) Connect a +3.3V supply to the 3.3V terminal and ground to the GND terminal.
- 2) Install shunt at jumper JP10.
- 3) Disable system loopback by installing the LOOPBACK shunt at jumper JP9.
- 4) Remove shunts at jumpers JP3 and JP5 to enable TX and RX.
- 5) Install shunt at jumper JP2 to V<sub>CC</sub> to provide +3.3V to the SD pullup resistors.
- 6) Apply 2.5Gbps to 3.2Gbps data to TX\_IN[1:4] (J9 - J16).
- 7) Apply 2.5Gbps to 3.2Gbps data to RX\_IN[1:4] (J19 - J26).
- 8) Connect data outputs RX\_OUT[1:4] (J1 - J8) to a 50 ohm-terminated oscilloscope to monitor RX\_IN[1:4] data, and/or connect TX\_OUT[1:4] (J27 - J34) to a 50 ohm-terminated oscilloscope to monitor TX\_IN[1:4] data.
- 9) Adjust TX pre-emphasis with jumpers JP1 and JP12, and adjust RX pre-emphasis with JP8 (see *Jumper Descriptions*).



# MAX3983 SMA Connector Evaluation Kit

## Jumper Descriptions

Evaluates: MAX3983

NAME	TYPE	SHUNT POSITION	DESCRIPTION
TX_PE1 (JP1)	2-pin header	OPEN	Enables most-significant bit of TX pre-emphasis control
		SHUNT (GND)	Disables most-significant bit of TX pre-emphasis control
TX_PE0 (JP12)	2-pin header	OPEN	Enables least-significant bit of TX pre-emphasis control
		SHUNT (GND)	Disables least-significant bit of TX pre-emphasis control
RX_PE (JP8)	2-pin header	OPEN	Sets RX pre-emphasis to 6dB
		SHUNT (GND)	Sets RX pre-emphasis to 3dB
LOOPBACK (JP9)	2-pin header	OPEN	Enables loopback from TX_IN[1:4] to RX_OUT[1:4]
		SHUNT (GND)	Disables loopback
VCCTX (JP10)	2-pin header	SHUNT	Jumper JP10 must be shunted for proper operation of the MAX3983
PULLUP (JP2)	2-pin header	OPEN	Allows external voltage (3.0V to 5.5V) applied at V <sub>PULLUP</sub> pin as SD resistor pullup voltage
		SHUNT (V <sub>CC</sub> )	Sets V <sub>CC</sub> as the SD resistor pullup voltage
TX_ENABLE (JP3)	3-pin header	OPEN	Enables the TX section of the MAX3983
		TX_AUTO_EN	Enables auto-detection in the TX section, when EV board is set up in the Auto-Detect configuration. See <i>Auto-Detect Configuration in Detailed Description</i> .
		TX_DISABLE	Disables the TX section of the MAX3983
RX_ENABLE (JP5)	3-pin + 1-pin header	OPEN 	Enables the RX section of the MAX3983
		RX_AUTO_EN 	Enables auto-detection in the RX section when EV board is set up in the Auto-Detect configuration. See <i>Auto-Detect Configuration in Detailed Description</i> .
		RX_DISABLE 	Disables the RX section of the MAX3983
			Sets RX_ENABLE high whenever LOOPBACK or all of RX_SD[1:4] are high when EV board is set up in the Auto-Detect configuration. See <i>Auto-Detect Configuration in Detailed Description</i> .

## Detailed Description

### Auto-Detect Configuration

The MAX3983 SMA Connector Evaluation Kit is shipped with each signal detect (SD) separated. In order for the MAX3983 to automatically detect an incoming signal and enable the corresponding output, these SD outputs need to be connected together.

To configure the board for auto-detection on the RX side, solder four 0Ω 0402 resistors in R14 - R17 and remove R6, R7, and R8. Jumper JP5 then enables RX auto-detect (see *Jumper Descriptions*).

To configure the board for auto-detection on the TX side, solder four 0Ω 0402 resistors in R10 - R13 and remove R2, R3, and R4. Jumper JP3 then enables TX auto-detect (see *Jumper Descriptions*).

### Output Transition Times

If slower transition times are desired, the MAX3983 SMA Connector Evaluation Kit provides a connection for 0402 capacitors across the TX outputs. To achieve about 100ps (20%-80%) edges, solder 1.5pF capacitors for C47, C48, C50, and C51.

# MAX3983 SMA Connector Evaluation Kit

Evaluates: MAX3983

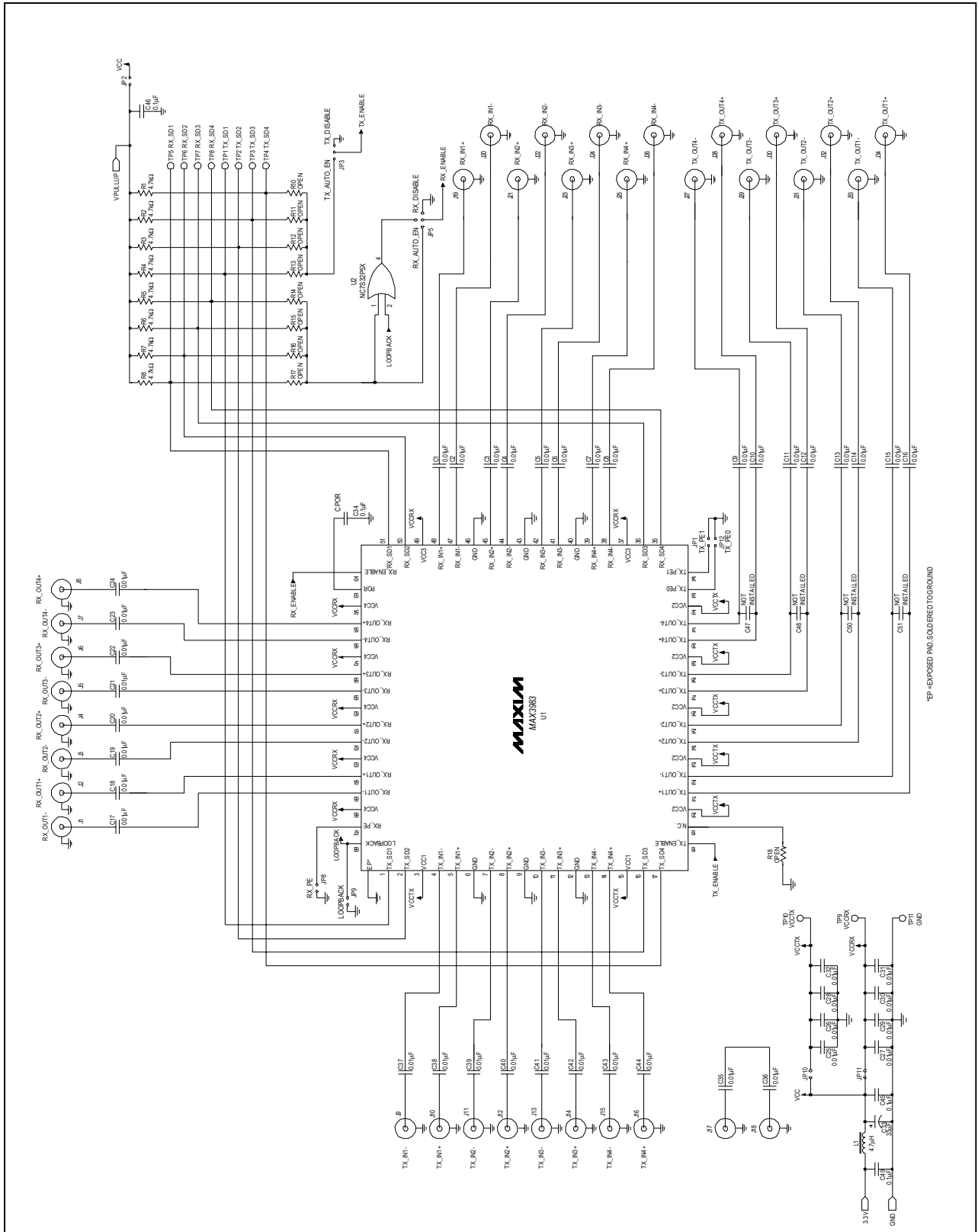

Figure 1. MAX3983 SMA Connector EV Kit Schematic

# MAX3983 SMA Connector Evaluation Kit

Evaluates: MAX3983

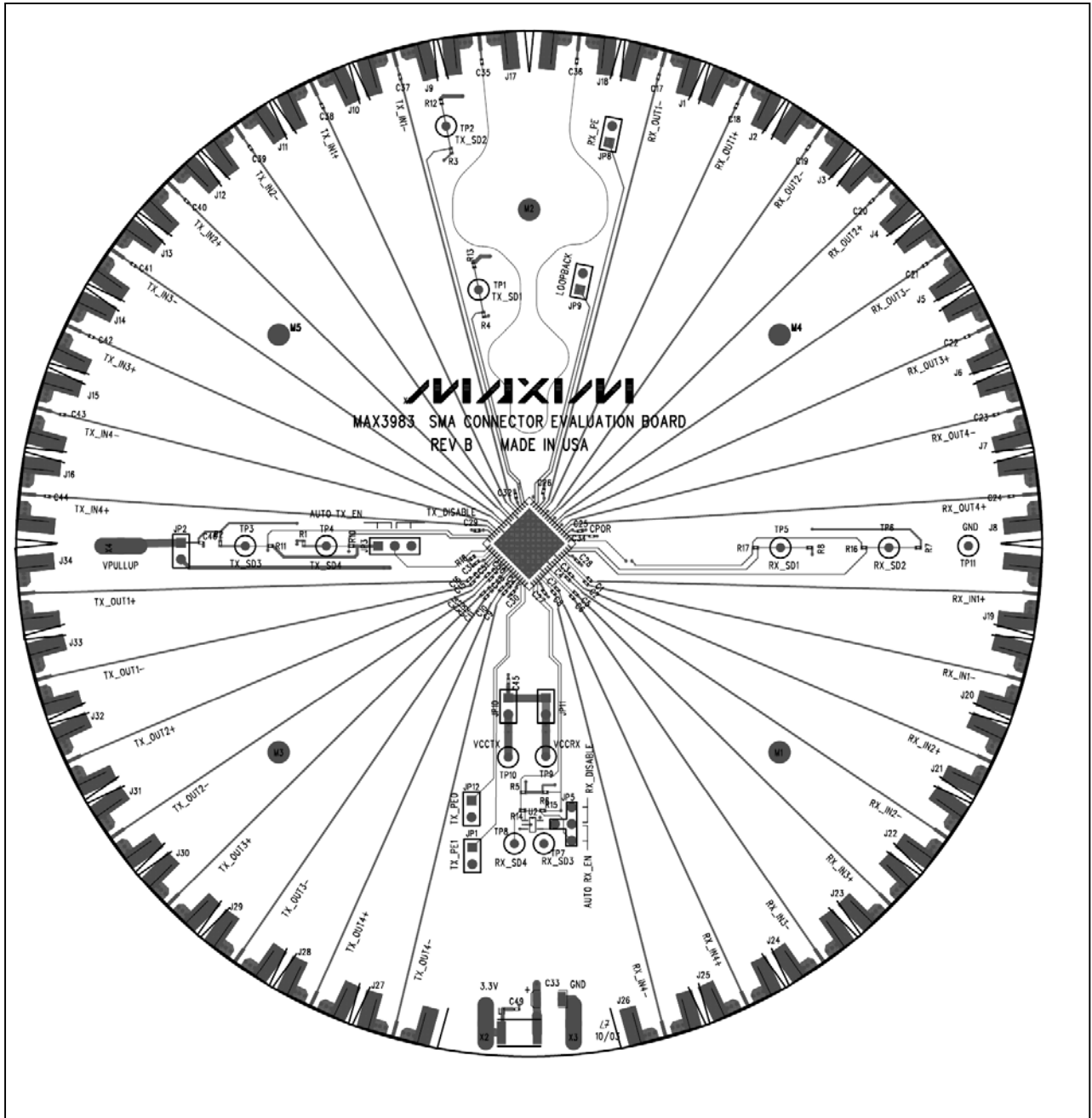

Figure 2. MAX3983 SMA Connector EV Kit Component Placement Guide – Component Side

# MAX3983 SMA Connector Evaluation Kit

Evaluates: MAX3983

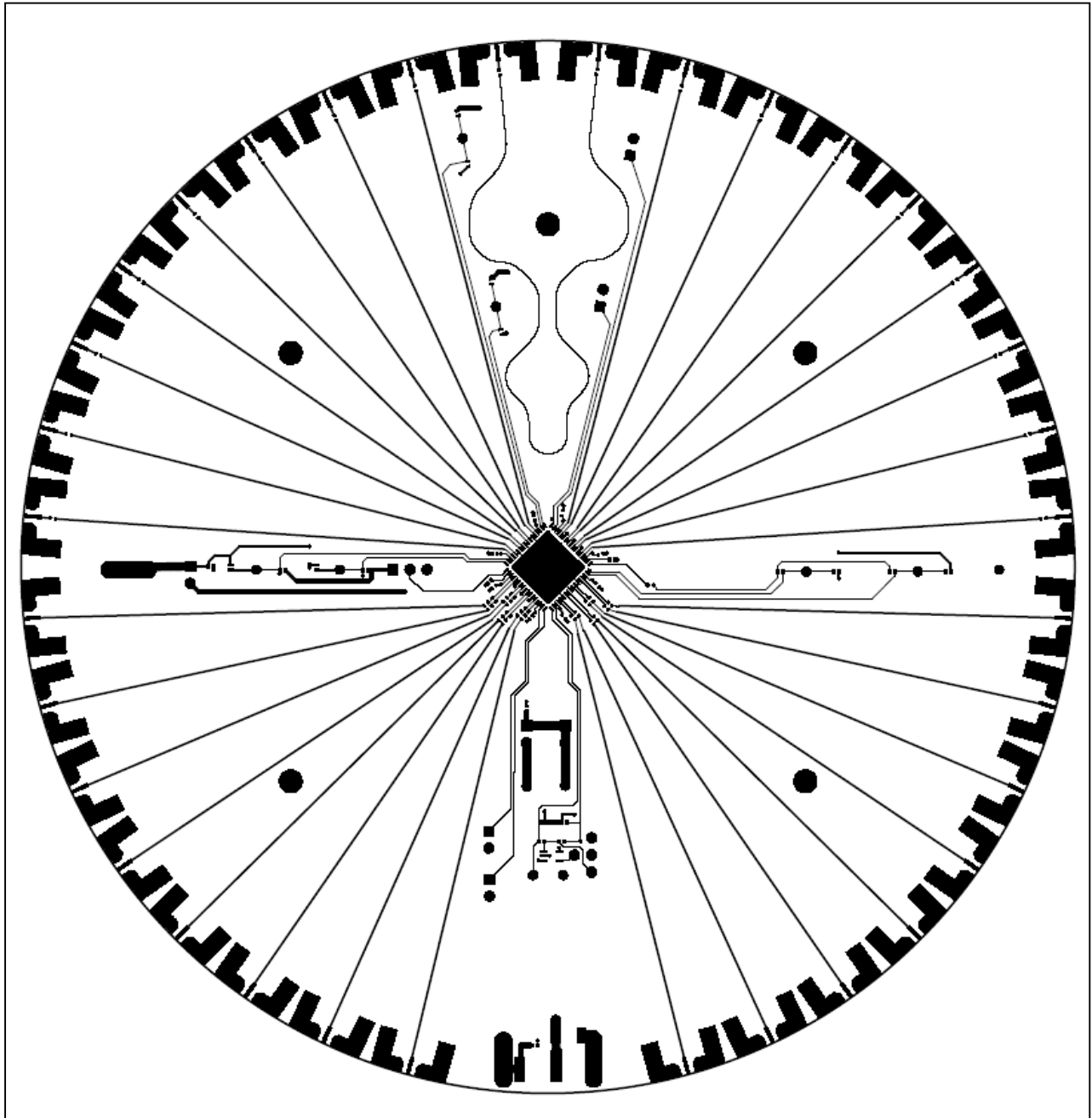

Figure 3. MAX3983 SMA Connector EV Kit PC Board Layout – Component Side

# MAX3983 SMA Connector Evaluation Kit

**Evaluates: MAX3983**



Figure 4. MAX3983 SMA Connector EV Kit PC Board Layout – Ground Plane

# MAX3983 SMA Connector Evaluation Kit

Evaluates: MAX3983

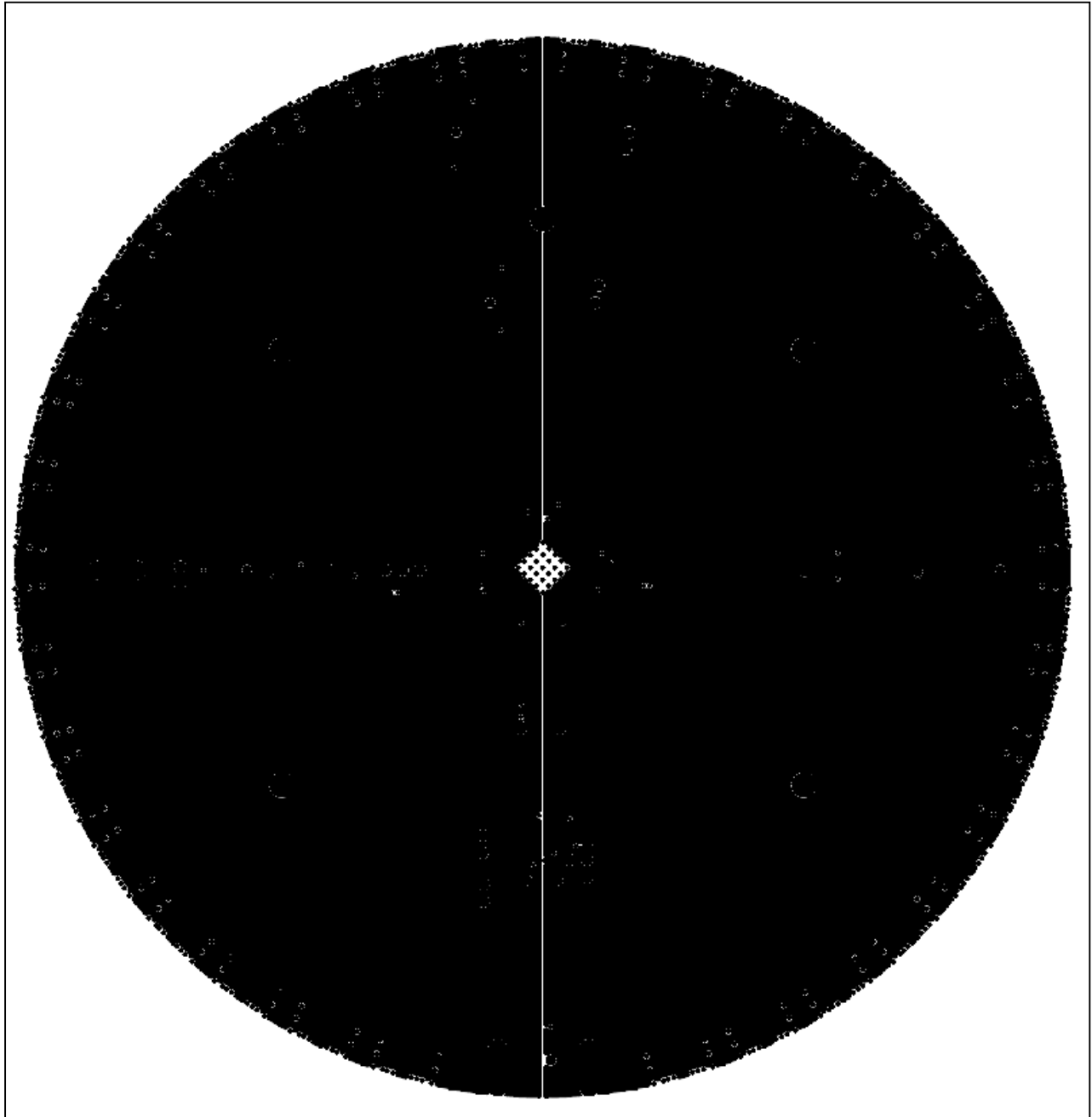

Figure 5. MAX3983 SMA Connector EV Kit PC Board Layout – Power Plane

# MAX3983 SMA Connector Evaluation Kit

Evaluates: MAX3983

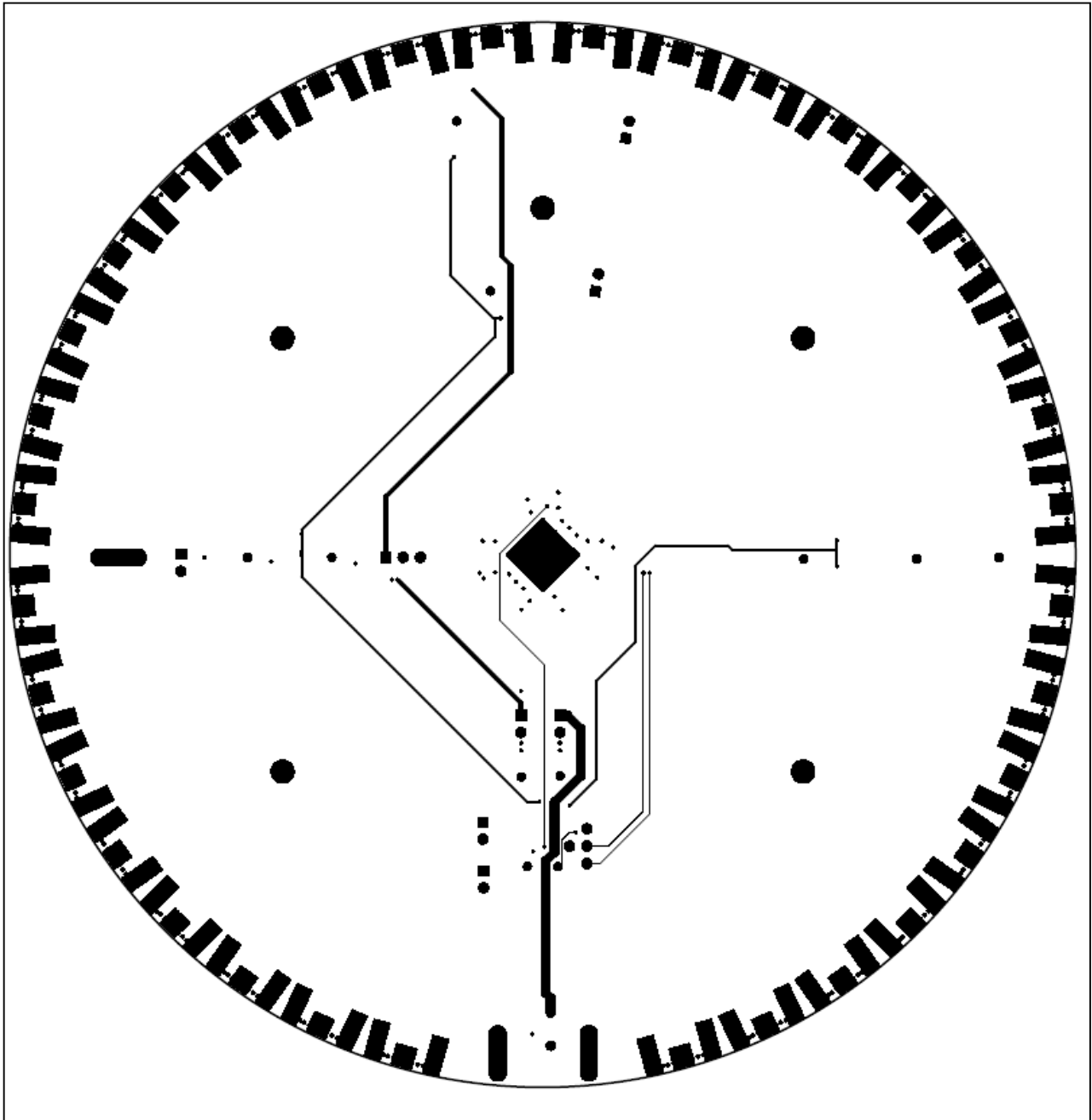

Figure 6. MAX3983 SMA Connector EV Kit PC Board Layout – Solder (Bottom) Side

Maxim cannot assume responsibility for use of any circuitry other than circuitry entirely embodied in a Maxim product. No circuit patent licenses are implied. Maxim reserves the right to change the circuitry and specifications without notice at any time.