

# Chip resistor networks

## MNR12 (1608 × 2 size)

### ●Features

- 1) Convex electrodes  
Easy to check the fillet after soldering is finished.
- 2) Small, light, rectangular 2-chip network  
Area ratio is 65% smaller than that of MNR32, while weight ratio has been cut 75%.
- 3) High-density mounting  
Can be mounted even more densely than two 1608 chips (MCR03), and mounting costs are lower.
- 4) Compatible with a wide range of mounting equipment.  
Squared corners make it excellent for mounting using image recognition devices.
- 5) ROHM resistors have approved ISO-9001 certification.  
Design and specifications are subject to change without notice. Carefully check the specification sheet supplied with the product before using or ordering it.

### ●Ratings

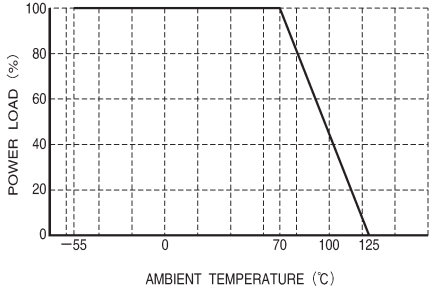
Item	Conditions	Specifications	
Rated power	<p>Power must be derated according to the power derating curve in Figure 1 when ambient temperature exceeds 70°C.</p>  <p style="text-align: center;">Fig.1</p>	0.063W (1 / 16W) at 70°C	
Rated voltage	<p>The voltage rating is calculated by the following equation. If the value obtained exceeds the maximum operating voltage, the voltage rating is equal to the maximum operating voltage.</p> $E = \sqrt{P \times R}$ <p>E: Rated voltage (V) P: Rated power (W) R: Nominal resistance (Ω)</p>	<p>Max. operating voltage</p> <p>Max. overload voltage</p> <p>Max. intermittent overload voltage</p>	<p>50V</p> <p>100V</p> <p>100V</p>
Nominal resistance	See Table 1.		
Operating temperature		-55°C to +125°C	

## Jumper type

Resistance	Max. 50mΩ
Rated current	1A
Peak current	3A
Operating temperature	-55°C to +125°C

Table 1

Resistance tolerance	Resistance range (Ω)	Resistance temperature coefficient (ppm / °C)
J (±5%)	10 ≤ R ≤ 1M (E24)	±200

● Before using components in circuits where they will be exposed to transients such as pulse loads (short-duration, high-level loads), be certain to evaluate the component in the mounted state. In addition, the reliability and performance of this component cannot be guaranteed if it is used with a steady state voltage that is greater than its rated voltage.

## ● Characteristics

Characteristics	Specifications		Test method (JIS C 5202)
	Chip resistance	Jumper type	
DC resistance	J : ±5%	Max. 50mΩ	JIS C 5202 5.1 Applied voltage: A
Resistance temperature characteristics	See Table 1.		JIS C 5202 5.2 Test conditions: +25 / -55 / +25 / +125°C
Short time overload	± (5.0% + 0.1 Ω)	Max. 50mΩ	JIS C 5202 5.5 Rated voltage (current) : ×2.5, 5s. Maximum overload voltage: 100V
Resistance to soldering heat	± (2.5% + 0.1 Ω) Outside must not be noticeably damaged.	Max. 50mΩ	JIS C 5202 6.4 Soldering conditions: 260 ± 5°C Soldering time: 10 ± 1s.
Solderability	95% of terminal surface must be covered by new soldering, and there must be no soldering corrosion.		JIS C 5202 6.5 Rosin methanol: (25%WT) Soldering conditions: 235 ± 5°C Soldering time: 2.0 ± 0.5s.
Resistance to dry heat	± (5.0% + 0.1 Ω)	Max. 100mΩ	JIS C 5202 7.2 125°C Test time: 1,000 to 1,048 hrs.
Endurance (rated load)	± (5.0% + 0.1 Ω)	Max. 100mΩ	JIS C 5202 7.10 Rated voltage (current), 70°C 1.5h: ON — 0.5h: OFF Test time: 1,000 to 1,048 hrs.
Endurance (under load in damp environment)	± (5.0% + 0.1 Ω)	Max. 100mΩ	JIS C 5202 7.9 Rated voltage (current), 60°C, 95%RH 1.5h: ON — 0.5h: OFF Test time: 1,000 to 1,048 hrs.
Resistance to humidity (steady state)	± (5.0% + 0.1 Ω)	Max. 100mΩ	JIS C 5202 7.5 85°C, 85%RH Test time: 1,000 to 1,048 hrs.
Temperature cycling	± (2.5% + 0.1 Ω)	Max. 50mΩ	JIS C 5202 7.4 Test temperature: -55°C to +125°C 100cyc.
Resistance to solvents	± (1.0% + 0.05 Ω) Markings must not be dissolved away.	Max. 50mΩ	JIS C 5202 6.9 Room temperature, static immersion, 1 min. Solvent: Isopropyl alcohol

● External dimensions (Units: mm)

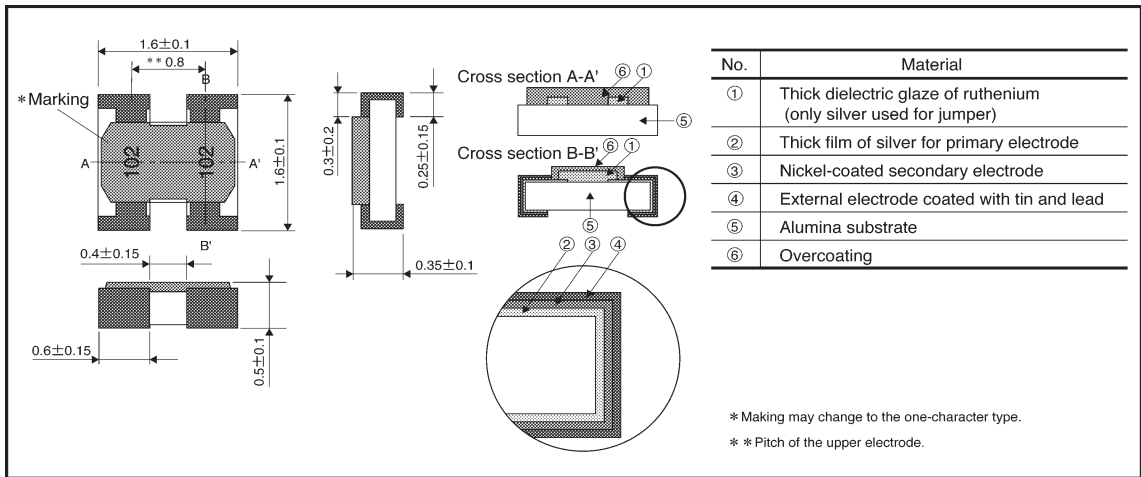

● Equivalent circuit

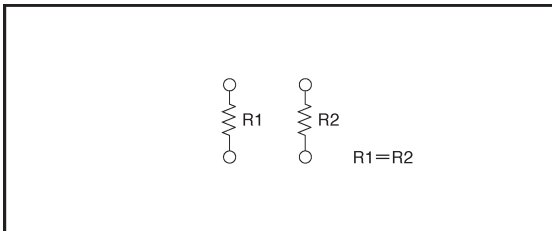

●Packaging

Reel	Taping
------	--------

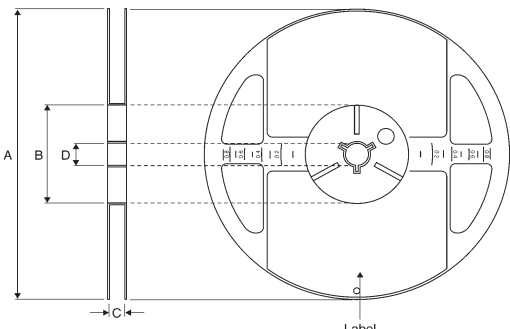

Label

EIAJ ET-7001 compliant

(Units : mm)

A	B	C	D
$\phi 180 \begin{smallmatrix} 0 \\ -3 \end{smallmatrix}$	$\phi 60 \begin{smallmatrix} +1 \\ 0 \end{smallmatrix}$	9±0.3	$\phi 13 \pm 0.2$

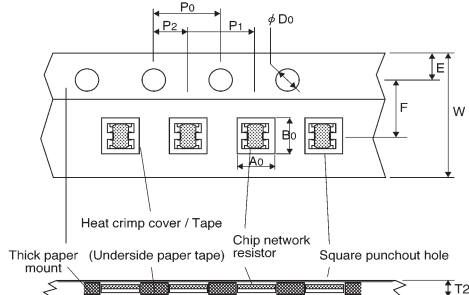

(Units : mm)

W	F	E	A <sub>0</sub>	B <sub>0</sub>
8.0±0.3	3.5±0.05	1.75±0.1	1.8±0.1	1.8±0.1
D <sub>0</sub>	P <sub>0</sub>	P <sub>1</sub>	P <sub>2</sub>	T <sub>2</sub>
$\phi 1.5 \begin{smallmatrix} +0.1 \\ 0 \end{smallmatrix}$	4.0±0.1	4.0±0.1	2.0±0.05	Max. 1.1

●Makeup of the part number

Part No.

M

N

R

1

2

E

0

A

B

J

⏟

Packaging / Processing specifications

⏟

Circuit configuration code

⏟

Resistance tolerance

⏟

Nominal resistance

Code	Part No.	Packaging	Package style	AB	MNR04/12/14/32/34	J	±5%	3-digit IEC coding system
E0	MNR12/14	Taping	Paper reel					

●Electrical characteristics

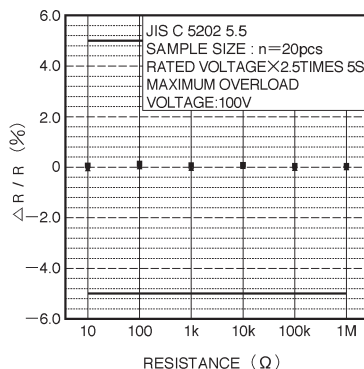
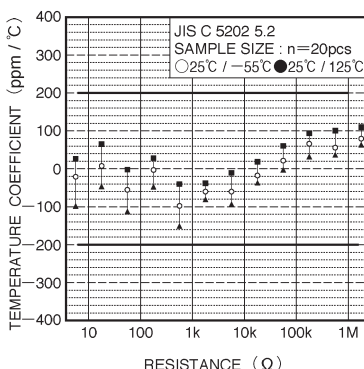
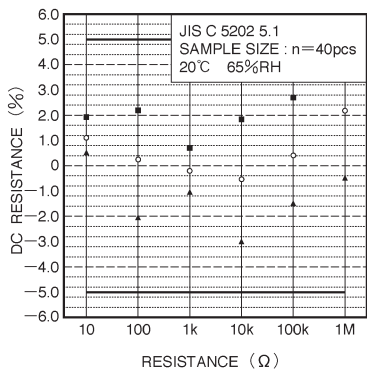

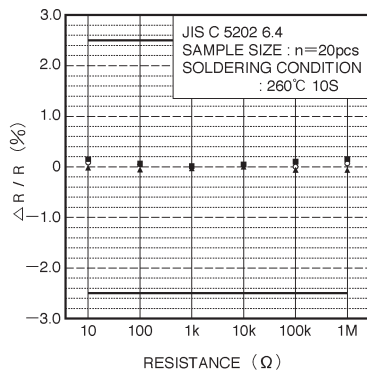

Fig.5 Resistance to soldering heat

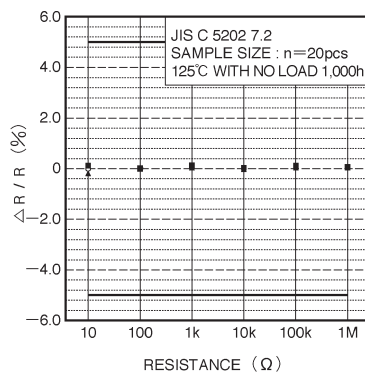

Fig.6 Resistance to dry heat

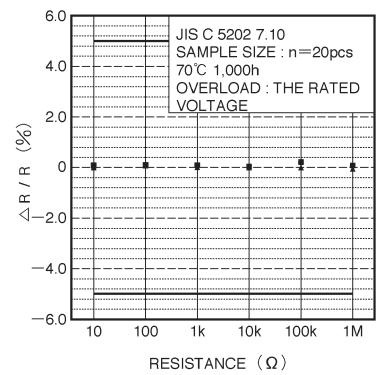

Fig.7 Endurance (rated load)

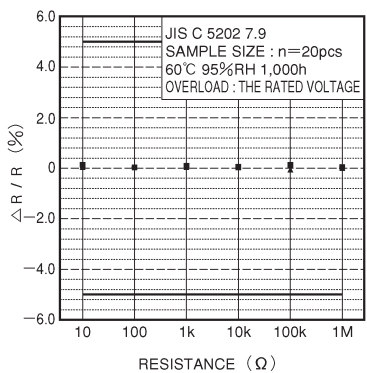
Fig.8 Endurance  
(under load in  
damp environment)Fig.9 Resistance to humidity  
(steady state)

Fig.10 Temperature cycling

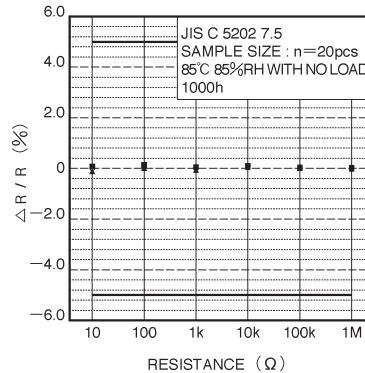
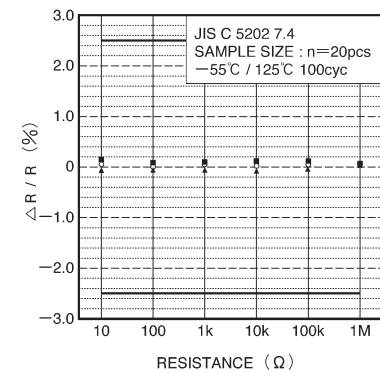
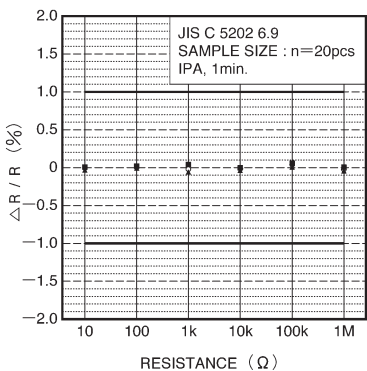

Fig.11 Resistance to solvents