

## 3A DUAL HIGH-SPEED POWER MOSFET DRIVERS

### FEATURES

- **High Peak Output Current** ..... 3A
- **Wide Operating Range** ..... 4.5V to 18V
- **High Capacitive Load Drive Capability** ..... 1800 pF in 25nsec
- **Short Delay Times** ..... < 40nsec Typ
- **Matched Rise/Fall Times**
- **Low Supply Current**
  - With Logic "1" Input ..... 3.5 mA
  - With Logic "0" Input ..... 350  $\mu$ A
- **Low Output Impedance** ..... 3.5 $\Omega$  Typ
- **Latch-Up Protected . Will Withstand 1.5A Reverse Current**
- **Logic Input Will Withstand Negative Swing Up to 5V**
- **ESD Protected** ..... 4 kV
- **Pinouts Same as TC1426/27/28; TC4426/27/28**

### ORDERING INFORMATION

Part No.	Package	Temperature Range
TC4423COE	16-Pin SOIC (Wide)	0°C to +70°C
TC4423CPA	8-Pin Plastic DIP	0°C to +70°C
TC4423EOE	16-Pin SOIC (Wide)	-40°C to +85°C
TC4423EPA	8-Pin Plastic DIP	-40°C to +85°C
TC4423MJA	8-Pin CerDIP	-55°C to +125°C
TC4424COE	16-Pin SOIC (Wide)	0°C to +70°C
TC4424CPA	8-Pin Plastic DIP	0°C to +70°C
TC4424EOE	16-Pin SO Wide	-40°C to +85°C

### GENERAL DESCRIPTION

The TC4423/4424/4425 are higher output current versions of the new TC4426/4427/4428 buffer/drivers, which, in turn, are improved versions of the earlier TC426/427/428 series. All three families are pin-compatible. The TC4423/4424/4425 drivers are capable of giving reliable service in far more demanding electrical environments than their antecedents.

Although primarily intended for driving power MOSFETs, the TC4423/4424/4425 drivers are equally well-suited to driving any other load (capacitive, resistive, or inductive) which requires a low impedance driver capable of high peak currents and fast switching times. For example, heavily loaded clock lines, coaxial cables, or piezoelectric transducers can all be driven from the TC4423/4424/4425. The only known limitation on loading is the total power dissipated in the driver must be kept within the maximum power dissipation limits of the package.

4

Part No	Package	Temperature Range
TC4424EPA	8-Pin Plastic DIP	-40°C to +85°C
TC4424MJA	8-Pin CerDIP	-55°C to +125°C
TC4425COE	16-Pin SO Wide	0°C to +70°C
TC4425CPA	8-Pin Plastic DIP	0°C to +70°C
TC4425EOE	16-Pin SO Wide	-40°C to +85°C
TC4425EPA	8-Pin Plastic DIP	-40°C to +85°C
TC4425MJA	8-Pin CerDIP	-55°C to +125°C

### FUNCTIONAL BLOCK DIAGRAM

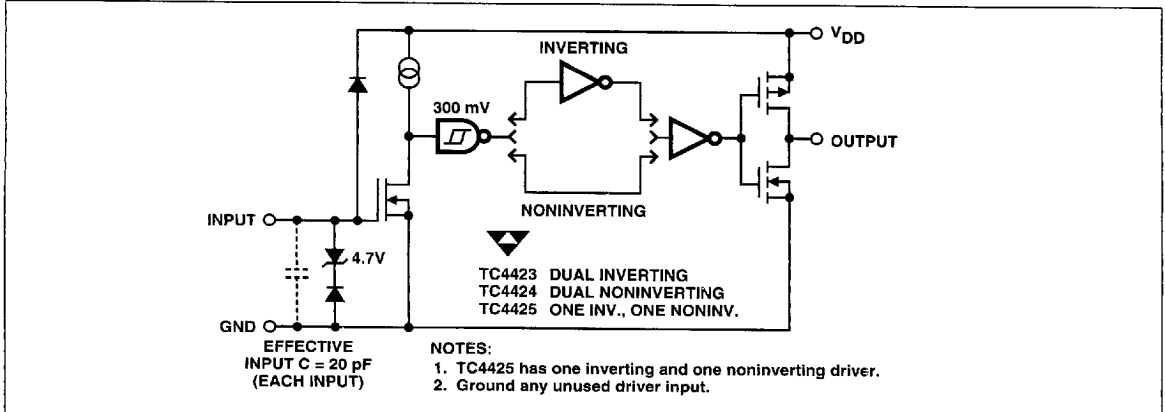

## TC4423 TC4424 TC4425

### ABSOLUTE MAXIMUM RATINGS\*

Supply Voltage .....	+22V
Input Voltage, IN A or IN B .....	$V_{DD} + 0.3V$ to GND - 5.0V
Maximum Chip Temperature .....	+150°C
Storage Temperature Range .....	- 65°C to +150°C
Lead Temperature (Soldering, 10 sec) .....	+300°C
Package Thermal Resistance	
CerDIP $R_{\theta J-A}$ .....	150°C/W
CerDIP $R_{\theta J-C}$ .....	55°C/W
PDIP $R_{\theta J-A}$ .....	125°C/W

PDIP $R_{\theta J-C}$ .....	45°C/W
SOIC $R_{\theta J-A}$ .....	155°C/W
SOIC $R_{\theta J-C}$ .....	75°C/W
Operating Temperature Range	
C Version .....	0°C to +70°C
I Version .....	- 25°C to +85°C
E Version .....	- 40°C to +85°C
M Version .....	- 55°C to +125°C
Package Power Dissipation ( $T_A \leq 70^\circ\text{C}$ )	
Plastic DIP .....	730mW
CerDIP .....	800mW
SOIC .....	470mW

### PIN CONFIGURATIONS

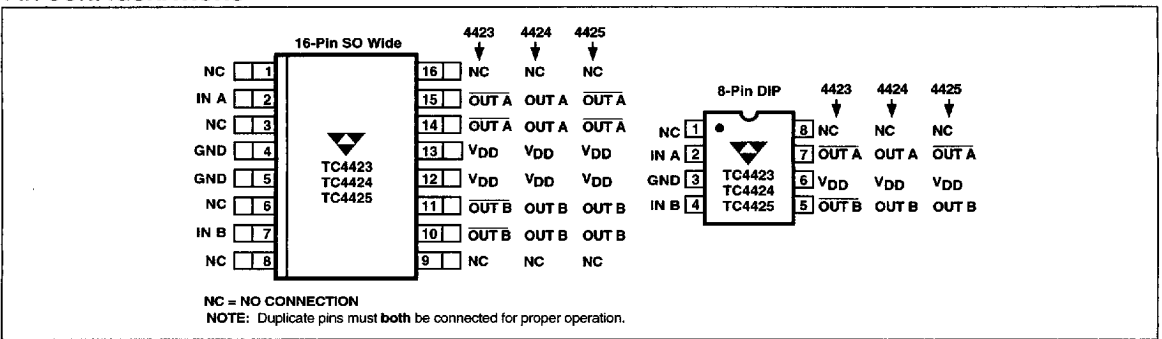

### ELECTRICAL CHARACTERISTICS: $T_A = +25^\circ\text{C}$ with $4.5V \leq V_{DD} \leq 18V$ , unless otherwise specified.

Symbol	Parameter	Test Conditions	Min	Typ	Max	Unit
<b>Input</b>						
$V_{OH}$	Logic 1 High Input Voltage		2.4	—	—	V
$V_{IL}$	Logic 0 Low Input Voltage		—	—	0.8	V
$I_{IN}$	Input Current	$0V \leq V_{IN} \leq V_{DD}$	-1	—	1	$\mu\text{A}$
<b>Output</b>						
$V_{OH}$	High Output Voltage		$V_{DD} - 0.025$	—	—	V
$V_{OL}$	Low Output Voltage		—	—	0.025	V
$R_O$	Output Resistance, High	$I_{OUT} = 10 \text{ mA}, V_{DD} = 18V$	—	2.8	5	$\Omega$
$R_O$	Output Resistance, Low	$I_{OUT} = 10 \text{ mA}, V_{DD} = 18V$	—	3.5	5	$\Omega$
$I_{PK}$	Peak Output Current		—	3	—	A
$I_{REV}$	Latch-Up Protection Withstand Reverse Current	Duty Cycle $\leq 2\%$ $t \leq 300 \mu\text{sec}$	1.5	—	—	A
<b>Switching Time (Note 1)</b>						
$t_R$	Rise Time	Figure 1, $C_L = 1800 \text{ pF}$	—	23	35	nsec
$t_F$	Fall Time	Figure 1, $C_L = 1800 \text{ pF}$	—	25	35	nsec
$t_{D1}$	Delay Time	Figure 1, $C_L = 1800 \text{ pF}$	—	33	75	nsec
$t_{D2}$	Delay Time	Figure 1, $C_L = 1800 \text{ pF}$	—	38	75	nsec
<b>Power Supply</b>						
$I_S$	Power Supply Current	$V_{IN} = 3V$ (Both Inputs) $V_{IN} = 0V$ (Both Inputs)	—	1.5 0.15	2.5 0.25	mA mA

**ELECTRICAL CHARACTERISTICS (Cont.):**

Over operating temperature range with  $4.5V \leq V_{DD} \leq 18V$ , unless otherwise specified.

Symbol	Parameter	Test Conditions	Min	Typ	Max	Unit
<b>Input</b>						
$V_{IH}$	Logic 1 High Input Voltage		2.4	—	—	V
$V_{IL}$	Logic 0 Low Input Voltage		—	—	0.8	V
$I_{IN}$	Input Current	$0V \leq V_{IN} \leq V_{DD}$	-10	—	10	$\mu A$
<b>Output</b>						
$V_{OH}$	High Output Voltage		$V_{DD} - 0.025$	—	—	V
$V_{OL}$	Low Output Voltage		—	—	0.025	V
$R_{OH}$	Output Resistance, High	$I_{OUT} = 10\text{ mA}, V_{DD} = 18V$	—	3.7	8	$\Omega$
$R_{OL}$	Output Resistance, Low	$I_{OUT} = 10\text{ mA}, V_{DD} = 18V$	—	4.3	8	$\Omega$
$I_{PK}$	Peak Output Current		—	3	—	A
$I_{REV}$	Latch-Up Protection Withstand Reverse Current	Duty Cycle $\leq 2\%$ $t \leq 300\ \mu\text{sec}$	1.5	—	—	A
<b>Switching Time (Note 1)</b>						
$t_R$	Rise Time	Figure 1, $C_L = 1800\text{ pF}$	—	28	60	nsec
$t_F$	Fall Time	Figure 1, $C_L = 1800\text{ pF}$	—	32	60	nsec
$t_{D1}$	Delay Time	Figure 1, $C_L = 1800\text{ pF}$	—	32	100	nsec
$t_{D2}$	Delay Time	Figure 1, $C_L = 1800\text{ pF}$	—	38	100	nsec
<b>Power Supply</b>						
$I_S$	Power Supply Current	$V_{IN} = 3V$ (Both Inputs) $V_{IN} = 0V$ (Both Inputs)	—	2 0.2	3.5 0.3	mA

**NOTE:** 1. Switching times guaranteed by design.

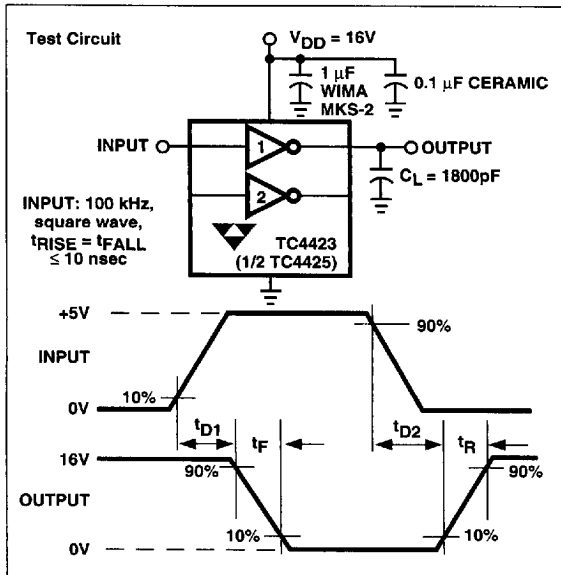

Figure 1. Inverting Driver Switching Time

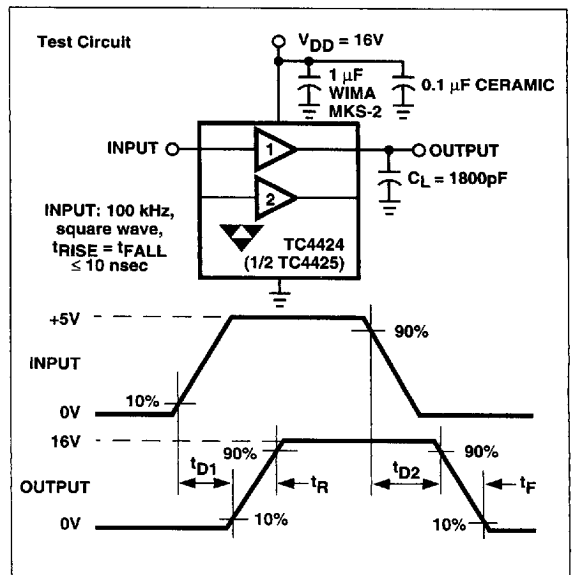
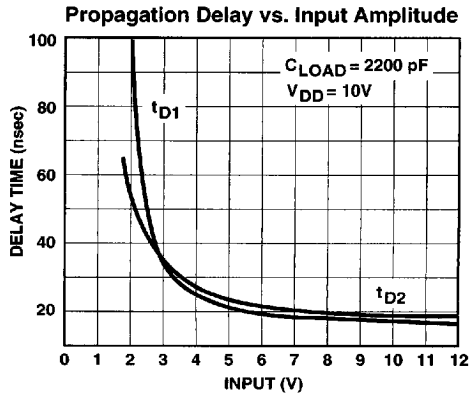
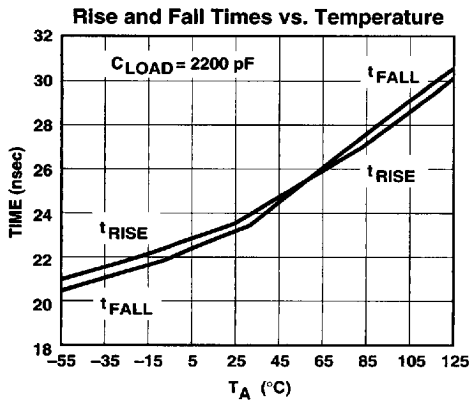
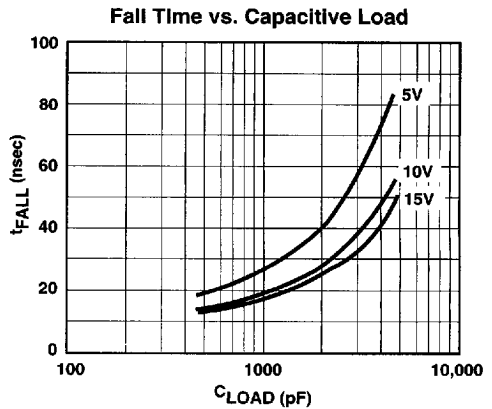
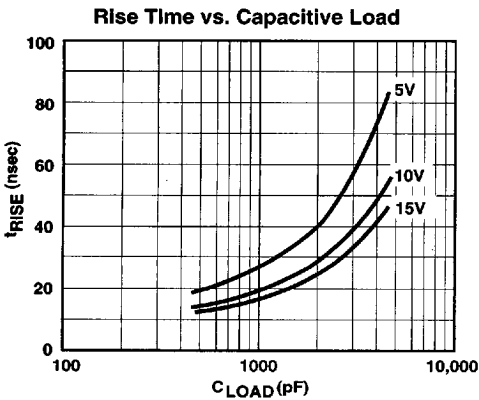
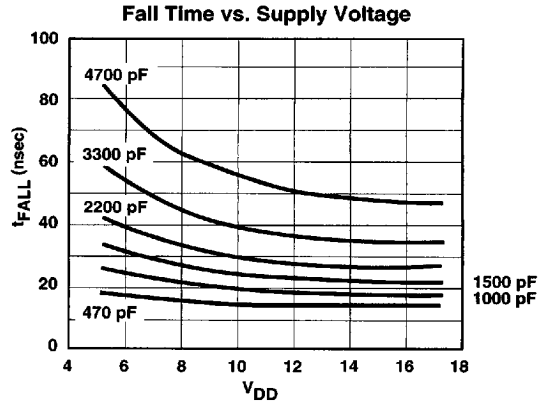
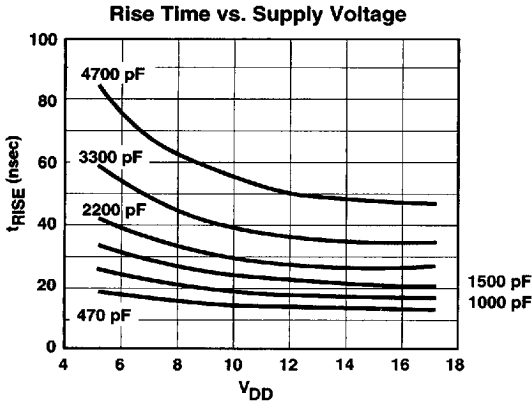

Figure 2. Noninverting Driver Switching Time

TC4423  
TC4424  
TC4425

## TYPICAL CHARACTERISTICS



TYPICAL CHARACTERISTICS (Cont.)

Propagation Delay Time vs. Supply Voltage

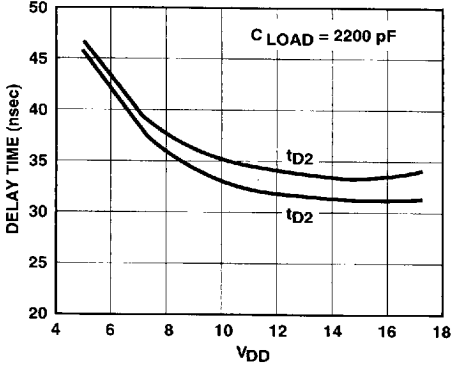

Delay Time vs. Temperature

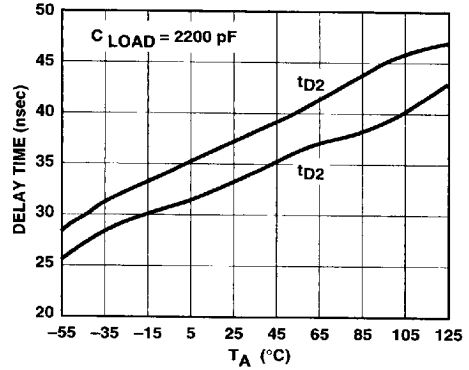

Quiescent Current vs. Supply Voltage

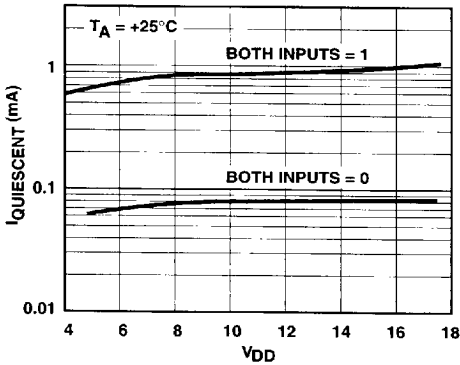

Quiescent Current vs. Temperature

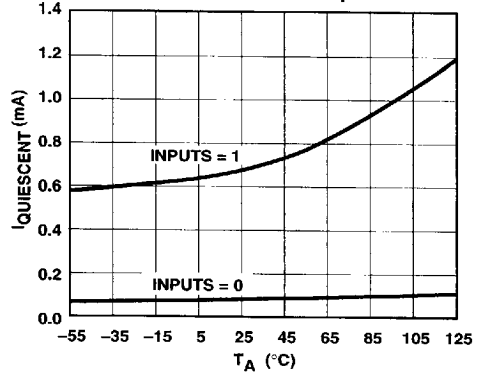

Output Resistance (Output High)  
vs. Supply Voltage

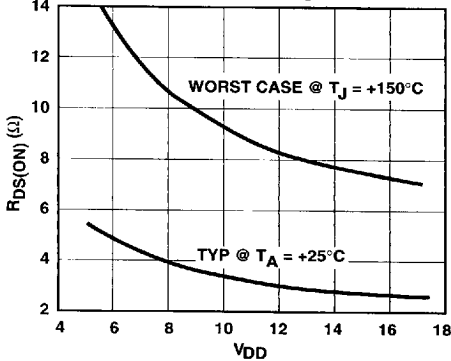

Output Resistance (Output Low)  
vs. Supply Voltage

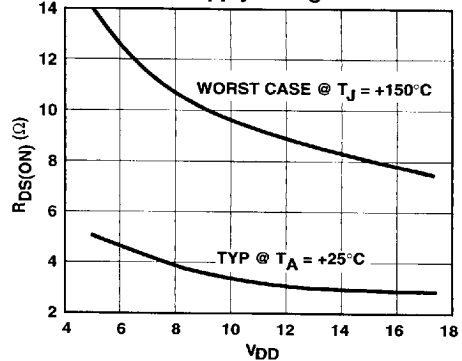

TC4423  
TC4424  
TC4425

SUPPLY CURRENT CHARACTERISTICS (Load on Single Output Only)

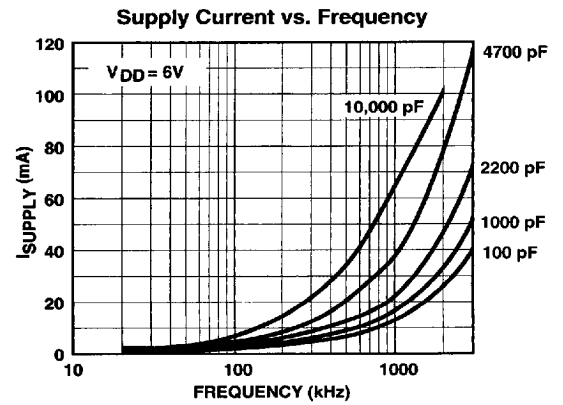
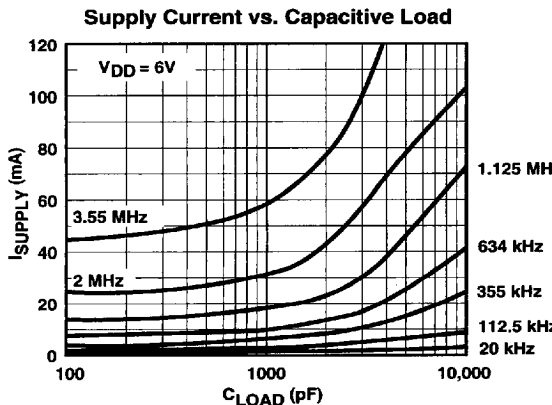
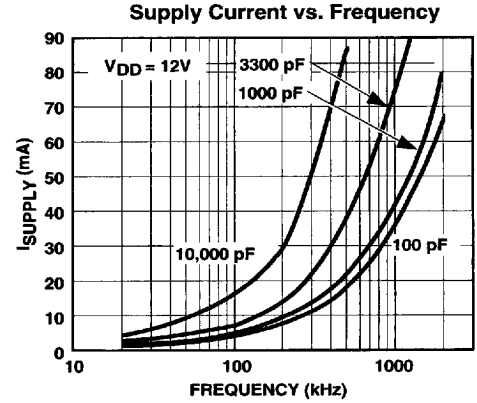
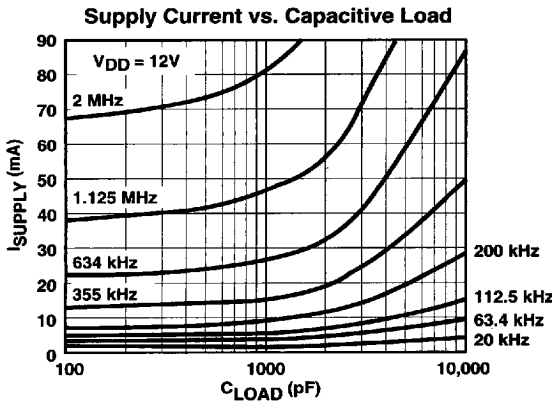
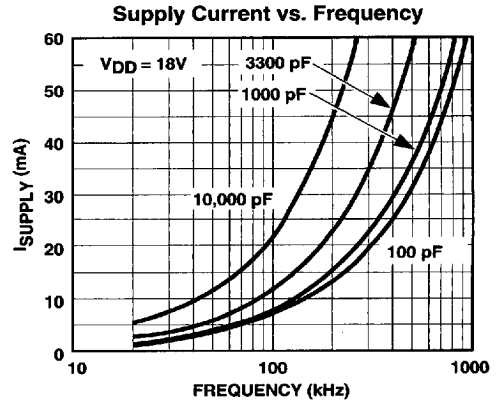
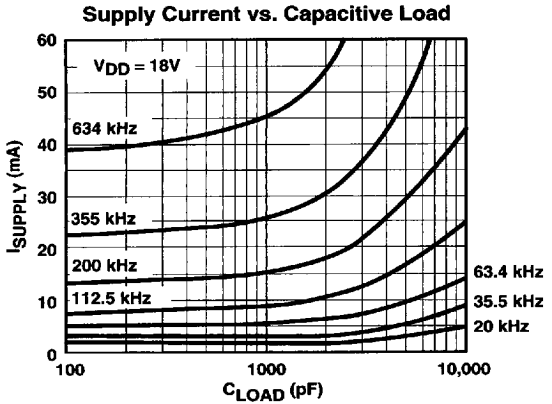

# 3A DUAL HIGH-SPEED MOSFET DRIVERS

TC4423  
TC4424  
TC4425

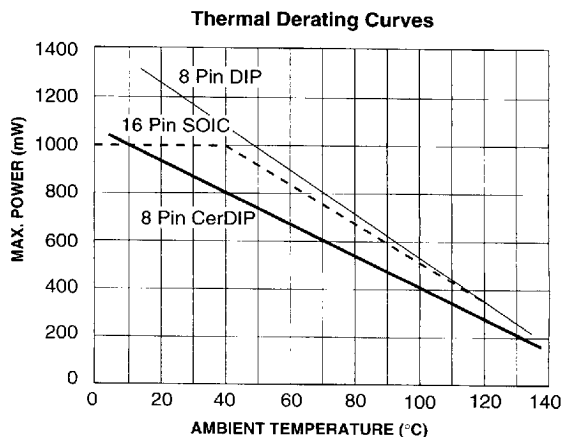
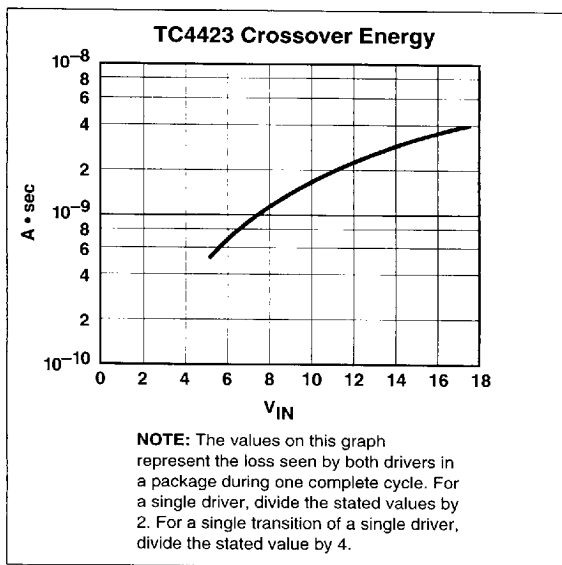

\*Static-sensitive device. Unused devices must be stored in conductive material. Protect devices from static discharge and static fields. Stresses above those listed under Absolute Maximum Ratings (See page 2) may cause permanent damage to the device. These are stress ratings only and functional operation of the device at these or any other conditions above those indicated in the operational sections of the specifications is not implied. Exposure to Absolute Maximum Rating Conditions for extended periods may affect device reliability.

4