

High Intensity LED, ø 3 mm Tinted Diffused

Color	Type	Technology	Angle of Half Intensity $\pm\varphi$
Double hetero red	TLDR4401	GaAIAs on GaAs	40°

Description

This LED contains the double heterojunction (DH) GaAIAs on GaAs technology. This deep red LED can be utilized over a wide range of drive current. It can be DC or pulse driven to achieve desired light output. The device is available in a 3 mm tinted diffused package.

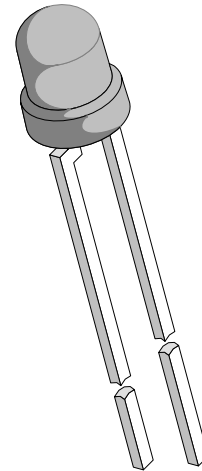

94 8398

Features

- Exceptional brightness
- Very high intensity even at low drive currents
- Wide viewing angle
- Low forward voltage
- 3 mm (T-1) tinted diffused package
- Deep red color
- Categorized for luminous intensity
- Outstanding material efficiency

Applications

Bright ambient lighting conditions
 Battery powered equipment
 Indoor and outdoor information displays
 Portable equipment
 Telecommunication indicators
 General use

Absolute Maximum Ratings

$T_{amb} = 25^{\circ}\text{C}$, unless otherwise specified

TLDR4401

Parameter	Test Conditions	Symbol	Value	Unit
Reverse voltage		V_R	6	V
DC forward current	$T_{amb} \leq 60^{\circ}\text{C}$	I_F	50	mA
Surge forward current	$t_p \leq 10 \mu\text{s}$	I_{FSM}	1	A
Power dissipation	$T_{amb} \leq 60^{\circ}\text{C}$	P_V	100	mW
Junction temperature		T_j	100	$^{\circ}\text{C}$
Operating temperature range		T_{amb}	-20 to +100	$^{\circ}\text{C}$
Storage temperature range		T_{stg}	-55 to +100	$^{\circ}\text{C}$
Soldering temperature	$t \leq 5 \text{ s}$, 2 mm from body	T_{sd}	260	$^{\circ}\text{C}$
Thermal resistance junction/ambient		R_{thJA}	400	K/W

Optical and Electrical Characteristics

$T_{amb} = 25^{\circ}\text{C}$, unless otherwise specified

Double hetero red (TLDR4401)

Parameter	Test Conditions	Type	Symbol	Min	Typ	Max	Unit
Luminous intensity	$I_F = 20 \text{ mA}$		I_V	25		50	mcd
Dominant wavelength	$I_F = 20 \text{ mA}$		λ_d		648		nm
Peak wavelength	$I_F = 20 \text{ mA}$		λ_p		650		nm
Spectral line half width	$I_F = 20 \text{ mA}$		$\Delta\lambda$		20		nm
Angle of half intensity	$I_F = 20 \text{ mA}$		ϕ		± 40		deg
Forward voltage	$I_F = 20 \text{ mA}$		V_F		1.8	2.2	V
Reverse current	$V_R = 6 \text{ V}$		I_R			10	μA
Junction capacitance	$V_R = 0$, $f = 1 \text{ MHz}$		C_j		30		pF

Typical Characteristics ($T_{amb} = 25^{\circ}\text{C}$, unless otherwise specified)

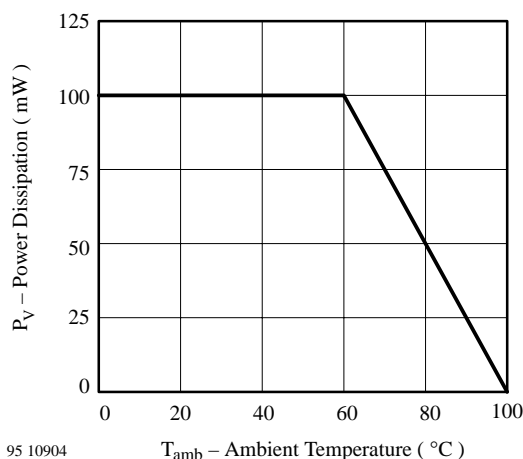

Figure 1 Power Dissipation vs. Ambient Temperature

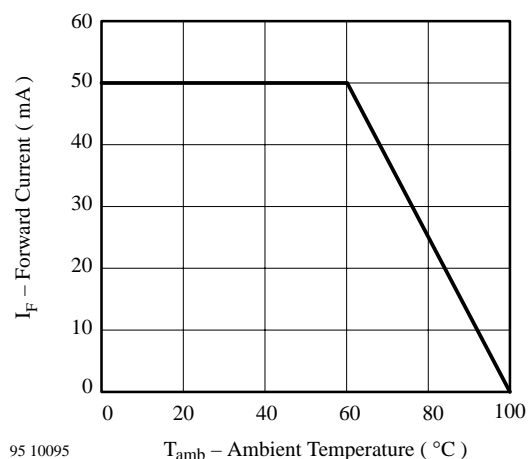
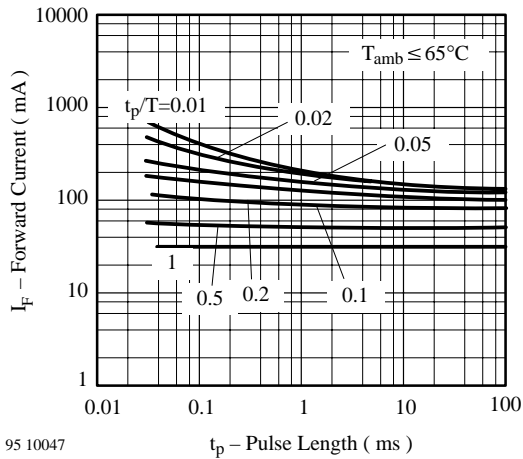
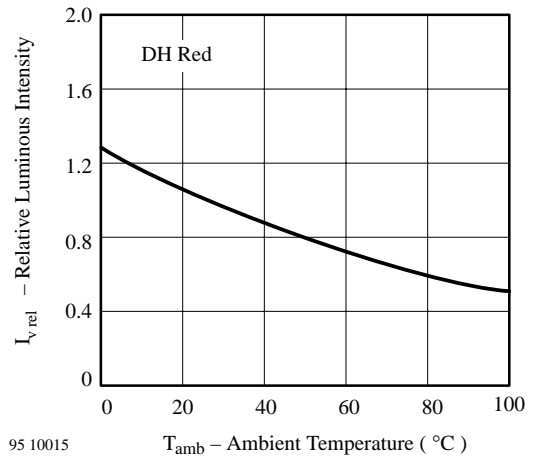

Figure 2 Forward Current vs. Ambient Temperature



95 10047

Figure 3 Forward Current vs. Pulse Length



95 10015

Figure 6 Rel. Luminous Intensity vs. Ambient Temperature

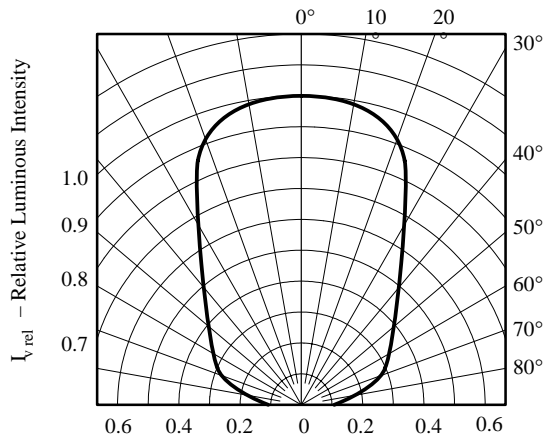

95 10020

Figure 4 Rel. Luminous Intensity vs. Angular Displacement

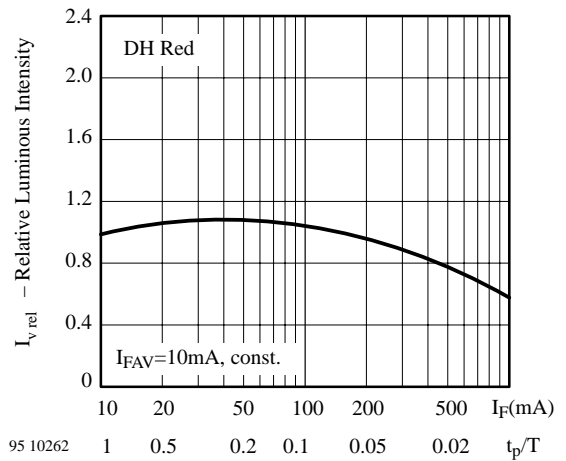

95 10262

Figure 7 Rel. Lumin. Intensity vs. Forw. Current/Duty Cycle

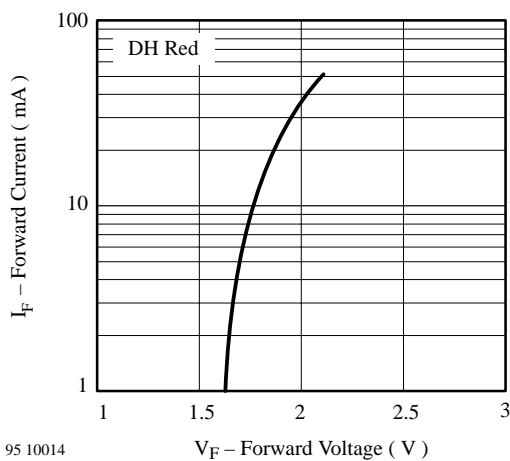

95 10014

Figure 5 Forward Current vs. Forward Voltage

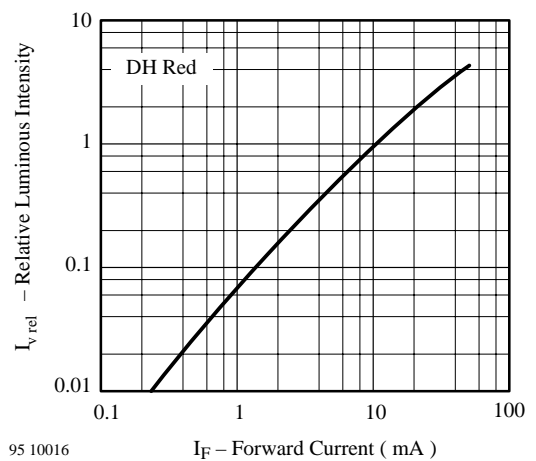

95 10016

Figure 8 Relative Luminous Intensity vs. Forward Current

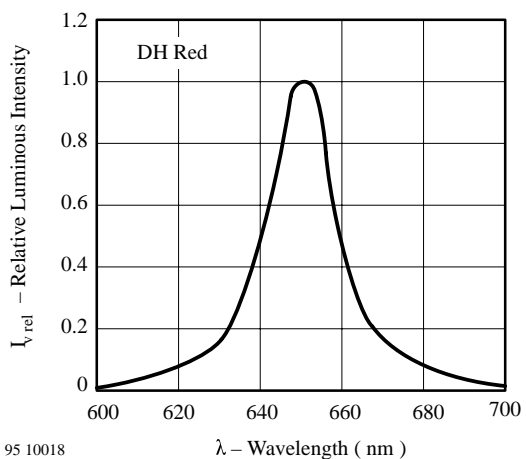
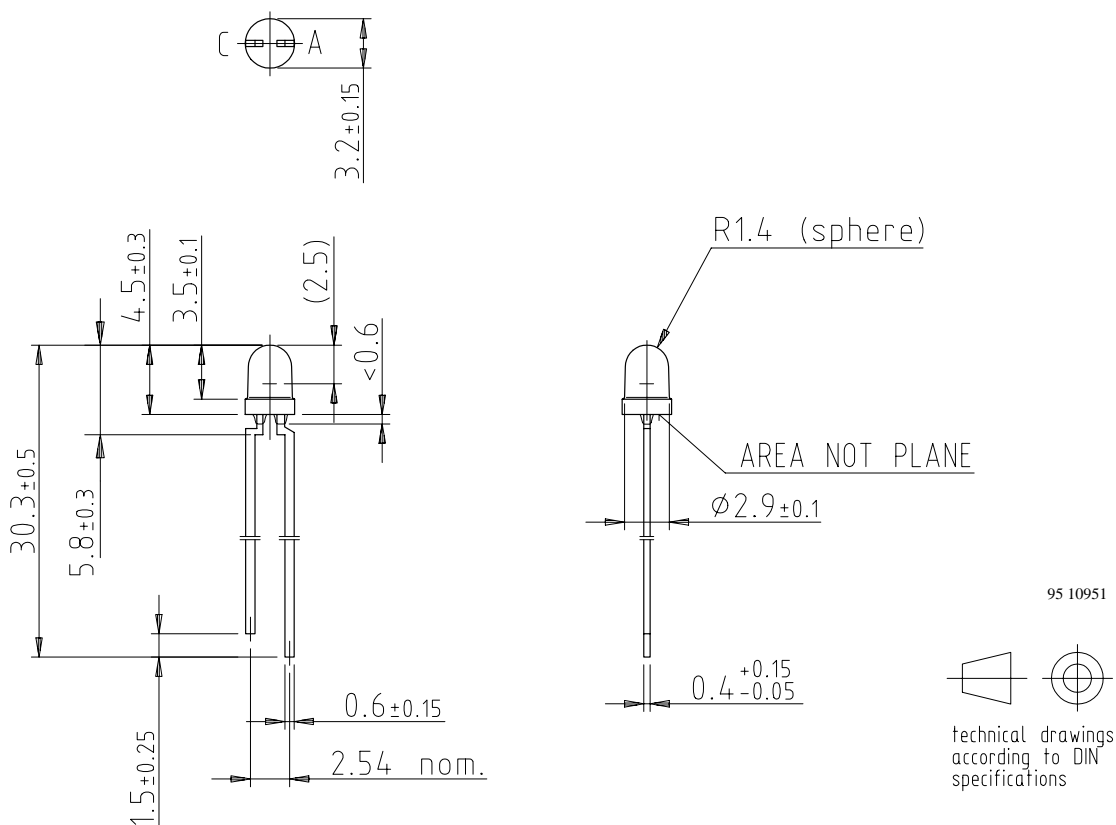

Figure 9 Relative Luminous Intensity vs. Wavelength

Dimensions in mm





Ozone Depleting Substances Policy Statement

It is the policy of **Vishay Semiconductor GmbH** to

1. Meet all present and future national and international statutory requirements.
2. Regularly and continuously improve the performance of our products, processes, distribution and operating systems with respect to their impact on the health and safety of our employees and the public, as well as their impact on the environment.

It is particular concern to control or eliminate releases of those substances into the atmosphere which are known as ozone depleting substances (ODSs).

The Montreal Protocol (1987) and its London Amendments (1990) intend to severely restrict the use of ODSs and forbid their use within the next ten years. Various national and international initiatives are pressing for an earlier ban on these substances.

Vishay Semiconductor GmbH has been able to use its policy of continuous improvements to eliminate the use of ODSs listed in the following documents.

1. Annex A, B and list of transitional substances of the Montreal Protocol and the London Amendments respectively
2. Class I and II ozone depleting substances in the Clean Air Act Amendments of 1990 by the Environmental Protection Agency (EPA) in the USA
3. Council Decision 88/540/EEC and 91/690/EEC Annex A, B and C (transitional substances) respectively.

Vishay Semiconductor GmbH can certify that our semiconductors are not manufactured with ozone depleting substances and do not contain such substances.

We reserve the right to make changes to improve technical design and may do so without further notice.

Parameters can vary in different applications. All operating parameters must be validated for each customer application by the customer. Should the buyer use Vishay-Telefunken products for any unintended or unauthorized application, the buyer shall indemnify Vishay-Telefunken against all claims, costs, damages, and expenses, arising out of, directly or indirectly, any claim of personal damage, injury or death associated with such unintended or unauthorized use.

Vishay Semiconductor GmbH, P.O.B. 3535, D-74025 Heilbronn, Germany
Telephone: 49 (0) 7131 67 2831, Fax number: 49 (0) 7131 67 2423