

RF & MICROWAVE TRANSISTORS
130...230MHz FM MOBILE APPLICATIONS

- FREQUENCY 175MHz
- VOLTAGE 13.6V
- POWER OUT 8 TO 25W
- HIGH POWER GAIN
- HIGH EFFICIENCY
- CLASS C TRANSISTORS
- COMMON EMITTER

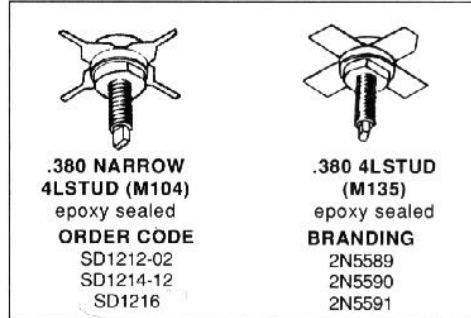

DESCRIPTION

The devices are epitaxial silicon NPN-planar transistors designed primarily for VHF mobile and marine transmitters.

These devices utilize ballasted emitter resistors and improved metallization systems to achieve extreme ruggedness under severe operating conditions.

device	package
2N5589	.380 NARROW 4LSTUD
2N5590	.380 4LSTUD
2N5591	.380 4LSTUD

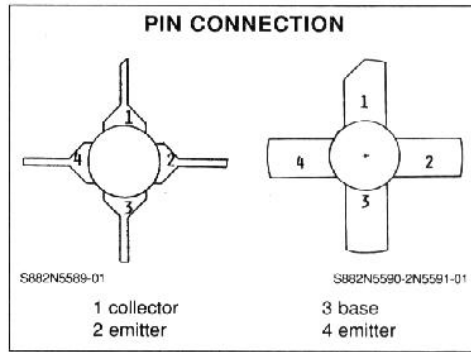

ABSOLUTE MAXIMUM RATINGS ($T_{case} = 25^{\circ}C$)

Symbol	Parameter	2N5589	2N5590	2N5591	Unit
V_{CBO}	Collector to Base Voltage	36.0	36.0	36.0	V
V_{CEO}	Collector to Emitter Voltage	18.0	18.0	18.0	V
V_{EBO}	Emitter to Base Voltage	4.0	4.0	4.0	V
$I_{C(max)}$	Continuous Collector Current	0.6	2.0	4.0	A
P_D	Total Dissipation at 25°C Stud	15.0	30.0	70.0	W
T_j	Junction Temperature	200	200	200	°C
T_{stg}	Storage Temperature	- 65 to 150	- 65 to 150	- 65 to 150	°C

		2N5589	2N5590	2N5591	
$R_{th(j-c)}$	Junction-case Thermal Resistance	11.7	5.8	2.5	°C/W

2N5589/2N5590/2N5591

ELECTRICAL CHARACTERISTICS ($T_{case} = 25^{\circ}C$)

STATIC

Symbol	Test Conditions	2N5589			2N5590			2N5591			Unit	
		Min.	Typ.	Max.	Min.	Typ.	Max.	Min.	Typ.	Max.		
BV_{CES}	$I_C = 200mA$ $V_{BE} = 0$	36			36			36			V	
BV_{CFO}	$I_C = 200mA$ $I_B = 0$	18			18			18			V	
BV_{EBO}	$I_E = 2.5mA$ $I_C = 0$	4	(I _E = 1mA)			4		4	(I _E = 5mA)			V
I_{CBO}	$V_{CB} = 15V$ $I_E = 0$			1			1			1	mA	
h_{FE}	$V_{CE} = 5V$ $I_C = 0.25A$	5	(I _C = 0.1A)			5		5	(I _C = 0.5A)			

DYNAMIC

Symbol	Test Conditions	2N5589			2N5590			2N5591			Unit
		Min.	Typ.	Max.	Min.	Typ.	Max.	Min.	Typ.	Max.	
P_O	$F = 175MHz$ $V_{CE} = 13.6V$ Class C	3.0			10			25			W
G_p	$F = 175MHz$ $V_{CE} = 13.6V$ Class C	8.2			5.2			4.4			dB
η_C	$F = 175MHz$ $V_{CB} = 13.6V$ Class C	50			50			50			%
C_{OB}	$V_{CB} = 15V$ $I_C = 0$ $F = 1MHz$			30			70			120	pF

APPLICATION INFORMATION (typical curves)

IMPEDANCE DATA (typical)

2N5589

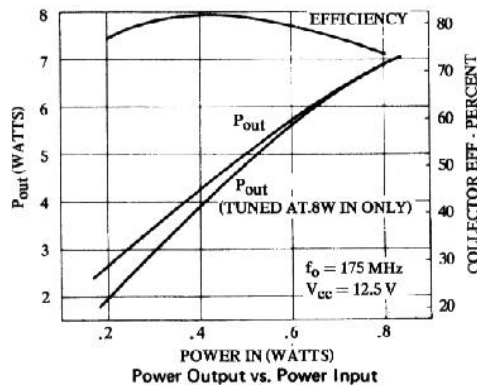

S882N5589-02

2N5589

$f = 175MHz, V_{CC} = 12.5V$			
P_{IN} WATTS	P_{OUT} WATTS	Input OHMS	OUTPUT OHMS
0.2	2.6	$2.9 + j0.5$	$15.0 + j16.8$
0.4	4.2	$3.5 + j0.2$	$14.2 + j10.4$
0.6	5.7	$3.7 + j0.1$	$13.0 + j7.3$
0.8	7.1	$4.0 + j0.3$	$12.3 + j5.8$

Network Impedance at Transistor Terminals

APPLICATION INFORMATION (typical curves) (continued)

IMPEDANCE DATA (typical) (continued)

2N5590

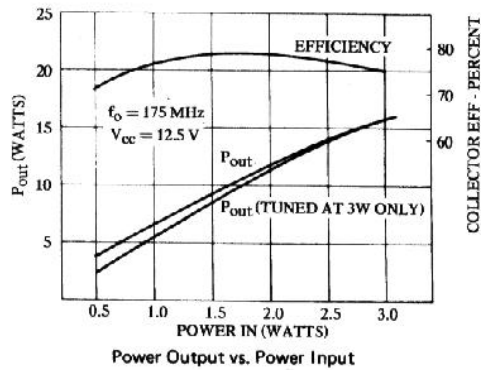

2N5590

$f = 175\text{MHz}, V_{CC} = 12.5\text{V}$

P _{IN} WATTS	P _{OUT} WATTS	Input OHMS	OUTPUT OHMS
0.5	3.8	1.4 + J2.0	9.0 + J8.9
1.0	6.6	1.5 + J2.4	10.0 + J5.1
2.0	11.8	1.6 + J2.5	8.6 + J1.3
3.0	15.8	1.8 + J2.6	6.9 + J0

Network Impedance at Transistor Terminals

2N5591

S882N5590-02

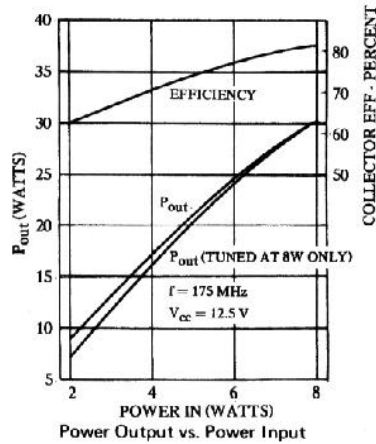

2N5591

$f = 175\text{MHz}, V_{CC} = 12.5\text{V}$

P _{IN} WATTS	P _{OUT} WATTS	Input OHMS	OUTPUT OHMS
2.0	10.0	.99 + J1.2	4.5 + J4.3
4.0	17.0	1.1 + J1.3	4.3 + J2.7
6.0	24.6	1.3 + J1.5	4.0 + J2.01
8.0	30.2	1.3 + J1.5	3.9 + J1.7

Network Impedance at Transistor Terminals

S882N5591-02

2N5589/2N5590/2N5591

PACKAGE MECHANICAL DATA

.380 NARROW 4LSTUD

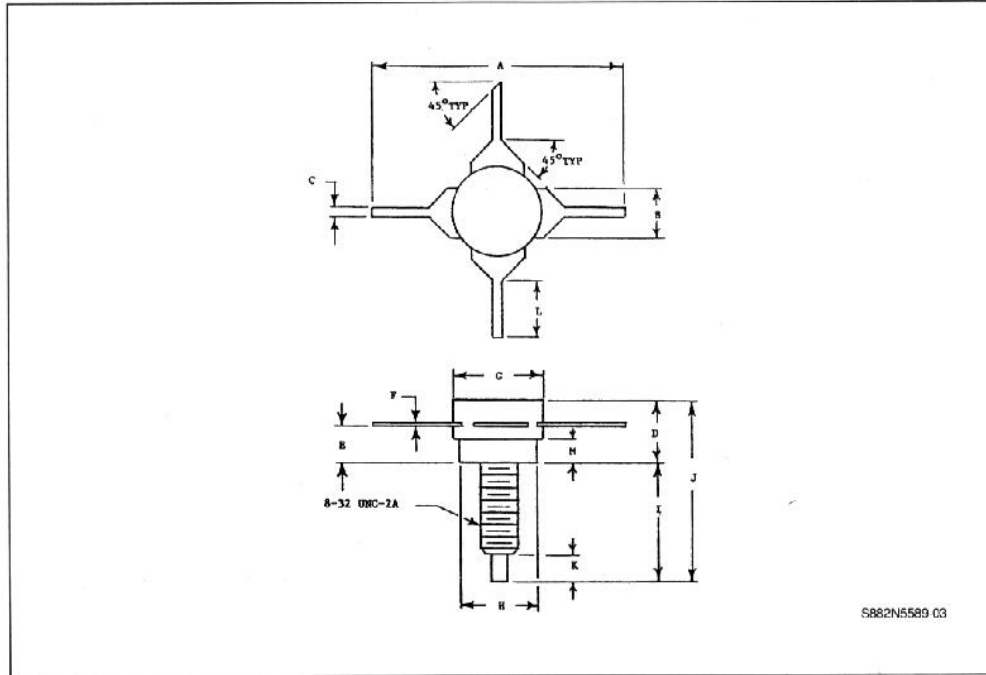

	Minimum Inches	Maximum Inches
A	1.000	
B	.220	.230
C	.025	.035
D		.275
E	.155	.175
F	.004	.007
G	.370	.380

	Minimum Inches	Maximum Inches
H	.320	.330
I	.450	.490
J		.750
K	.100	.130
L	.220	
M	.090	.100

PACKAGE MECHANICAL DATA (continued)

.380 4LSTUD

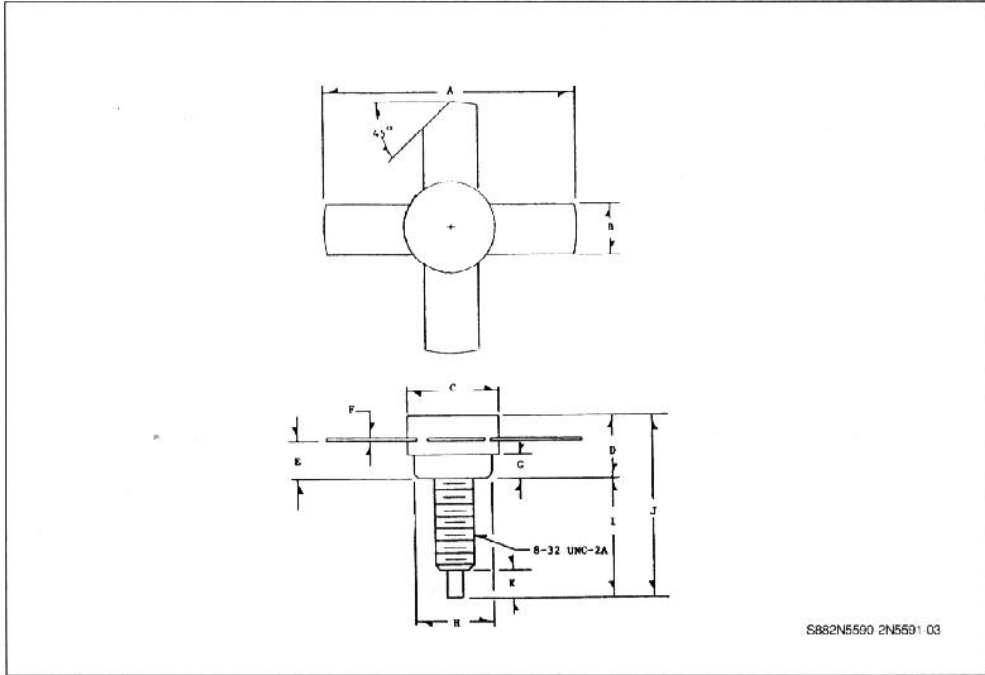

	Minimum Inches	Maximum Inches
A	.980	
B	.220	.230
C	.370	.385
D		.275
E	.155	.175
F	.004	.007

	Minimum Inches	Maximum Inches
G	.090	.100
H	.320	.330
I	.450	.490
J		.750
K	.100	.130