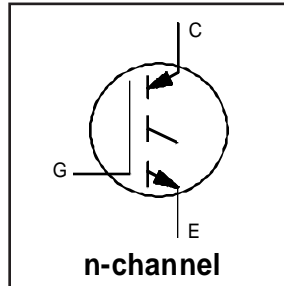


**INSULATED GATE BIPOLAR TRANSISTOR**

Short Circuit Rated  
UltraFast IGBT

**Features**

- Short circuit rated - 10 $\mu$ s @ 125°C, V<sub>GE</sub> = 15V
- Switching-loss rating includes all "tail" losses
- Optimized for high operating frequency (over 5kHz) See Fig. 1 for Current vs. Frequency curve

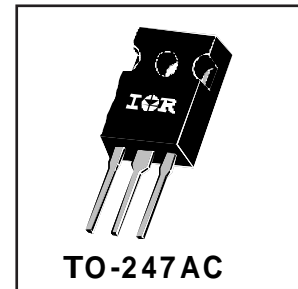


V<sub>CES</sub> = 600V  
V<sub>CE(sat)</sub> ≤ 3.8V  
@V<sub>GE</sub> = 15V, I<sub>C</sub> = 14A

**Description**

Insulated Gate Bipolar Transistors (IGBTs) from International Rectifier have higher usable current densities than comparable bipolar transistors, while at the same time having simpler gate-drive requirements of the familiar power MOSFET. They provide substantial benefits to a host of high-voltage, high-current applications.

These new short circuit rated devices are especially suited for motor control and other applications requiring short circuit withstand capability.



**Absolute Maximum Ratings**

	Parameter	Max.	Units
V <sub>CES</sub>	Collector-to-Emitter Voltage	600	V
I <sub>C</sub> @ T <sub>C</sub> = 25°C	Continuous Collector Current	23	A
I <sub>C</sub> @ T <sub>C</sub> = 100°C	Continuous Collector Current	14	
I <sub>CM</sub>	Pulsed Collector Current ①	46	
I <sub>LM</sub>	Clamped Inductive Load Current ②	46	
t <sub>sc</sub>	Short Circuit Withstand Time	10	μs
V <sub>GE</sub>	Gate-to-Emitter Voltage	±20	V
E <sub>ARV</sub>	Reverse Voltage Avalanche Energy ③	10	mJ
P <sub>D</sub> @ T <sub>C</sub> = 25°C	Maximum Power Dissipation	100	W
P <sub>D</sub> @ T <sub>C</sub> = 100°C	Maximum Power Dissipation	42	
T <sub>J</sub>	Operating Junction and Storage Temperature Range	-55 to +150	°C
T <sub>STG</sub>			
	Mounting torque, 6-32 or M3 screw.	10 lbf•in (1.1N•m)	

**Thermal Resistance**

	Parameter	Min.	Typ.	Max.	Units
R <sub>θJC</sub>	Junction-to-Case	—	—	1.2	°C/W
R <sub>θCS</sub>	Case-to-Sink, flat, greased surface	—	0.24	—	
R <sub>θJA</sub>	Junction-to-Ambient, typical socket mount	—	—	40	
Wt	Weight	—	6 (0.21)	—	g (oz)

## Electrical Characteristics @ $T_J = 25^\circ\text{C}$ (unless otherwise specified)

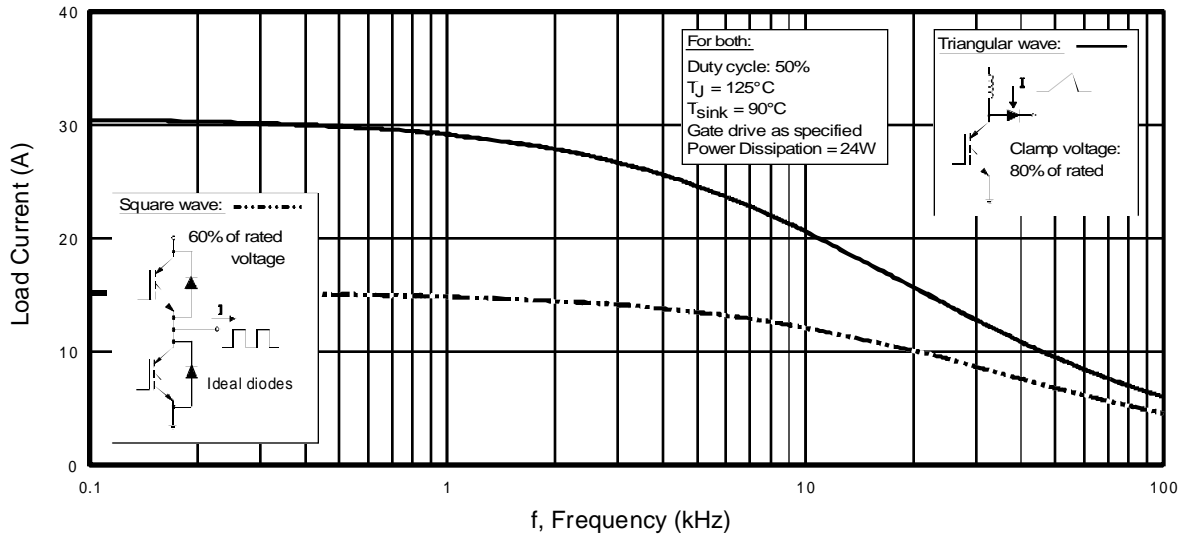
	Parameter	Min.	Typ.	Max.	Units	Conditions
$V_{(BR)CES}$	Collector-to-Emitter Breakdown Voltage	600	—	—	V	$V_{GE} = 0V, I_C = 250\mu A$
$V_{(BR)ECS}$	Emitter-to-Collector Breakdown Voltage ④	20	—	—	V	$V_{GE} = 0V, I_C = 1.0A$
$\Delta V_{(BR)CES}/\Delta T_J$	Temperature Coeff. of Breakdown Voltage	—	0.30	—	V/°C	$V_{GE} = 0V, I_C = 1.0mA$
$V_{CE(on)}$	Collector-to-Emitter Saturation Voltage	—	2.5	3.8	V	$I_C = 14A$ $I_C = 23A$ $I_C = 14A, T_J = 150^\circ\text{C}$ $V_{GE} = 15V$ See Fig. 2, 5
		—	3.3	—		
		—	2.5	—		
$V_{GE(th)}$	Gate Threshold Voltage	3.0	—	5.5		$V_{CE} = V_{GE}, I_C = 250\mu A$
$\Delta V_{GE(th)}/\Delta T_J$	Temperature Coeff. of Threshold Voltage	—	-13	—	mV/°C	$V_{CE} = V_{GE}, I_C = 250\mu A$
$g_{fe}$	Forward Transconductance ⑤	3.3	6.5	—	S	$V_{CE} = 100V, I_C = 14A$
$I_{CES}$	Zero Gate Voltage Collector Current	—	—	600	$\mu A$	$V_{GE} = 0V, V_{CE} = 600V$
		—	—	1100		$V_{GE} = 0V, V_{CE} = 600V, T_J = 150^\circ\text{C}$
$I_{GES}$	Gate-to-Emitter Leakage Current	—	—	$\pm 100$	nA	$V_{GE} = \pm 20V$

## Switching Characteristics @ $T_J = 25^\circ\text{C}$ (unless otherwise specified)

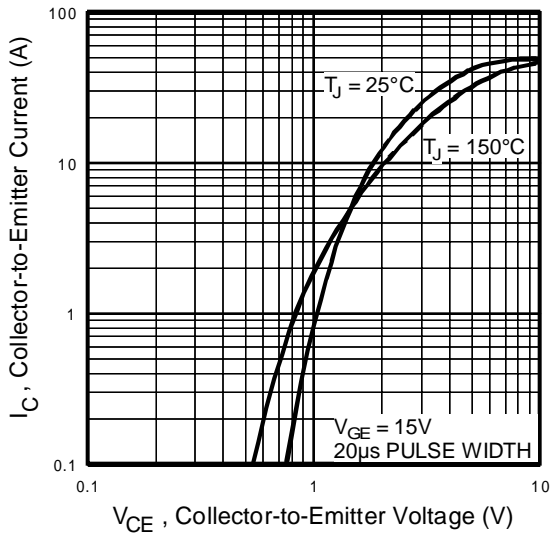
	Parameter	Min.	Typ.	Max.	Units	Conditions
$Q_g$	Total Gate Charge (turn-on)	—	39	58	nC	$I_C = 14A$ $V_{CC} = 400V$ $V_{GE} = 15V$ See Fig. 8
$Q_{ge}$	Gate - Emitter Charge (turn-on)	—	8.7	13		
$Q_{gc}$	Gate - Collector Charge (turn-on)	—	15	23		
$t_{d(on)}$	Turn-On Delay Time	—	31	—	ns	$T_J = 25^\circ\text{C}$ $I_C = 14A, V_{CC} = 480V$ $V_{GE} = 15V, R_G = 23\Omega$ Energy losses include "tail"
$t_r$	Rise Time	—	23	—		
$t_{d(off)}$	Turn-Off Delay Time	—	100	150		
$t_f$	Fall Time	—	84	130		
$E_{on}$	Turn-On Switching Loss	—	0.3	—		
$E_{off}$	Turn-Off Switching Loss	—	0.3	—	mJ	See Fig. 9, 10, 11, 14
$E_{ts}$	Total Switching Loss	—	0.6	0.9		
$t_{sc}$	Short Circuit Withstand Time	10	—	—	$\mu s$	$V_{CC} = 360V, T_J = 125^\circ\text{C}$ $V_{GE} = 15V, R_G = 23\Omega, V_{CPK} < 500V$
$t_{d(on)}$	Turn-On Delay Time	—	30	—	ns	$T_J = 150^\circ\text{C}$ , $I_C = 14A, V_{CC} = 480V$ $V_{GE} = 15V, R_G = 23\Omega$ Energy losses include "tail"
$t_r$	Rise Time	—	23	—		
$t_{d(off)}$	Turn-Off Delay Time	—	170	—		
$t_f$	Fall Time	—	170	—		
$E_{ts}$	Total Switching Loss	—	1.4	—	mJ	See Fig. 10, 14
$L_E$	Internal Emitter Inductance	—	13	—	nH	Measured 5mm from package
$C_{ies}$	Input Capacitance	—	740	—	pF	$V_{GE} = 0V$ $V_{CC} = 30V$ $f = 1.0MHz$ See Fig. 7
$C_{oes}$	Output Capacitance	—	92	—		
$C_{res}$	Reverse Transfer Capacitance	—	9.4	—		

### Notes:

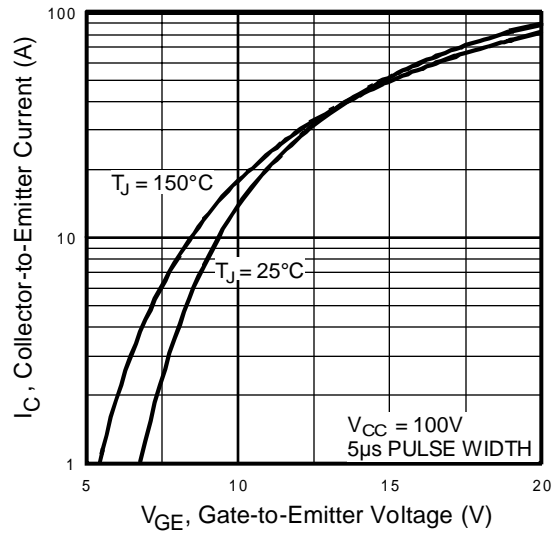
- ① Repetitive rating;  $V_{GE}=20V$ , pulse width limited by max. junction temperature. ( See fig. 13b )
- ②  $V_{CC}=80\%(V_{CES}), V_{GE}=20V, L=10\mu H, R_G=23\Omega$ , ( See fig. 13a )
- ③ Repetitive rating; pulse width limited by maximum junction temperature.
- ④ Pulse width  $\leq 80\mu s$ ; duty factor  $\leq 0.1\%$ .
- ⑤ Pulse width 5.0 $\mu s$ , single shot.



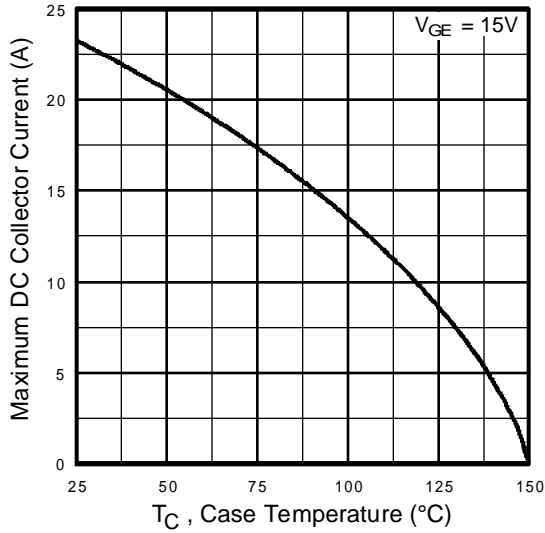
**Fig. 1 - Typical Load Current vs. Frequency**  
 (For square wave,  $I = I_{RMS}$  of fundamental; for triangular wave,  $I = I_{PK}$ )



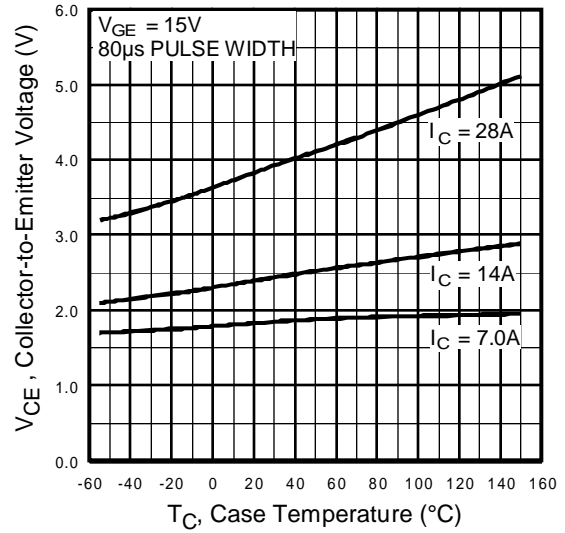
**Fig. 2 - Typical Output Characteristics**



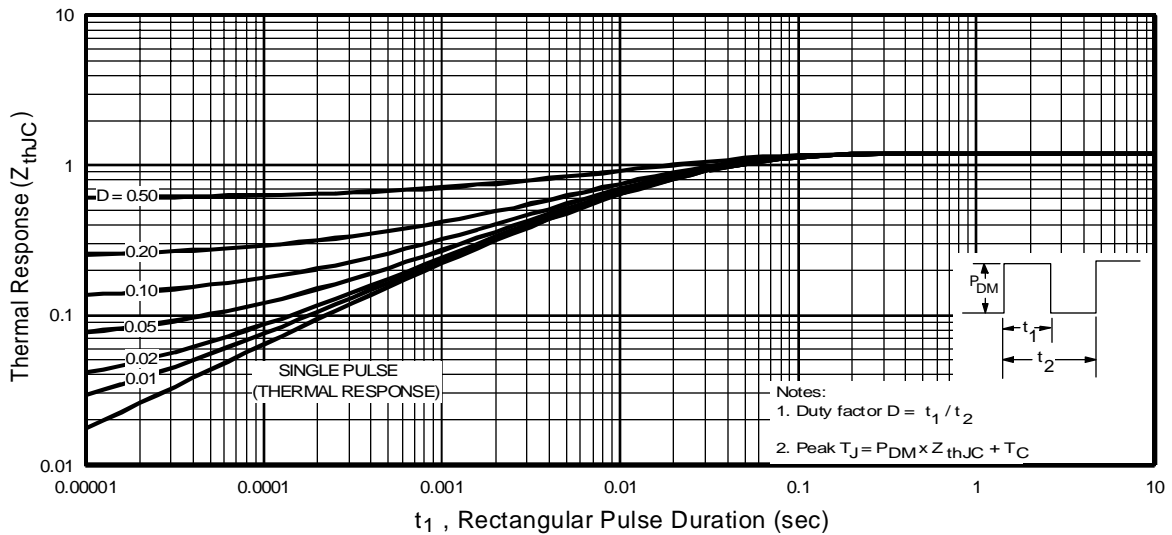
**Fig. 3 - Typical Transfer Characteristics**



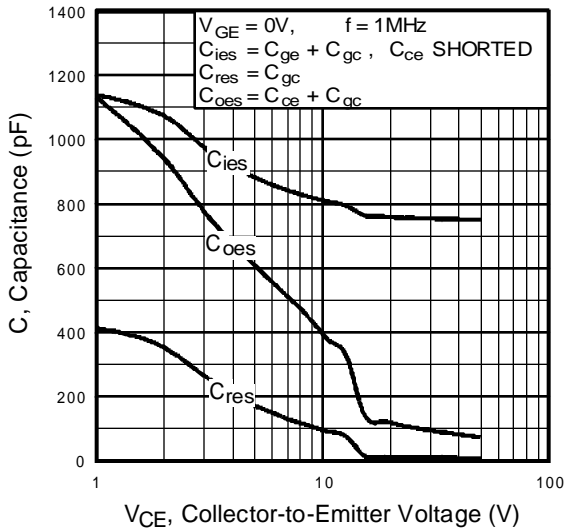
**Fig. 4** - Maximum Collector Current vs. Case Temperature



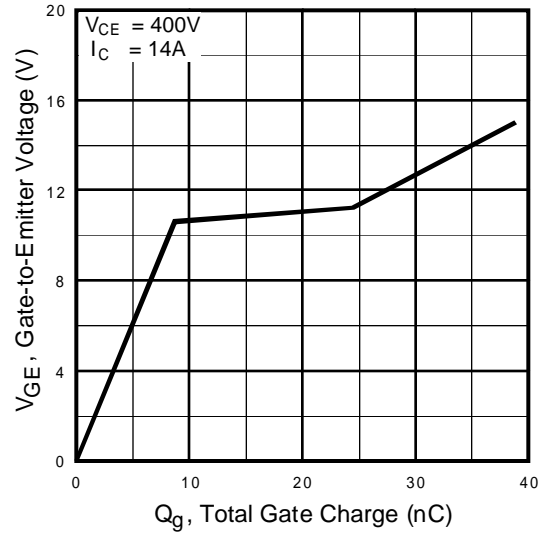
**Fig. 5** - Collector-to-Emitter Voltage vs. Case Temperature



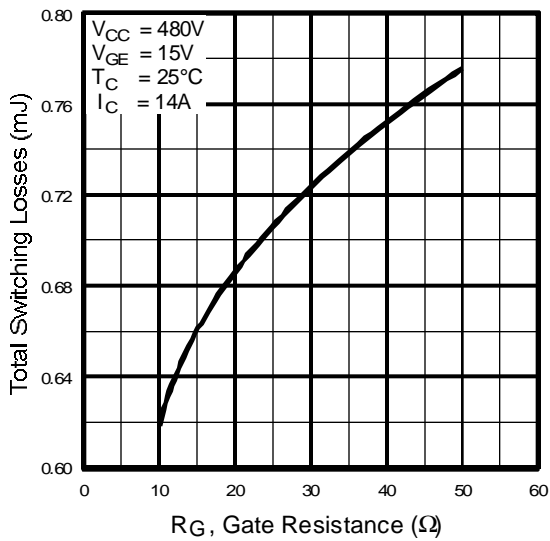
**Fig. 6** - Maximum Effective Transient Thermal Impedance, Junction-to-Case



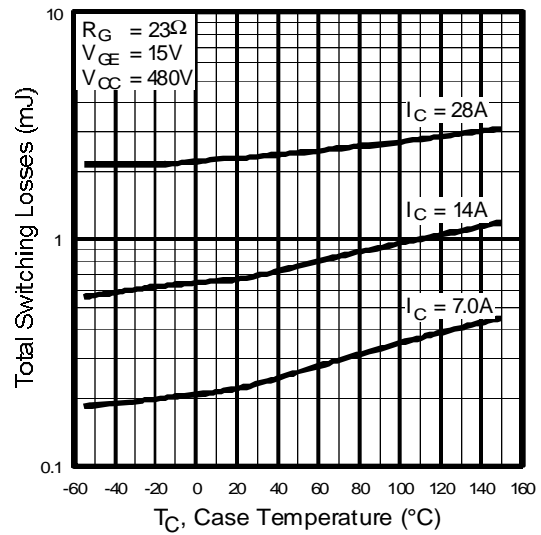
**Fig. 7 - Typical Capacitance vs. Collector-to-Emitter Voltage**



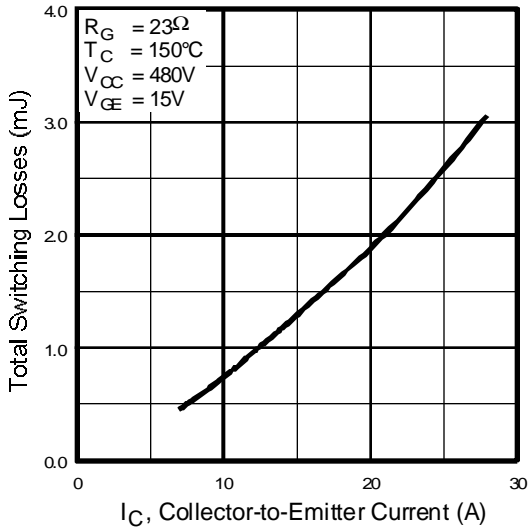
**Fig. 8 - Typical Gate Charge vs. Gate-to-Emitter Voltage**



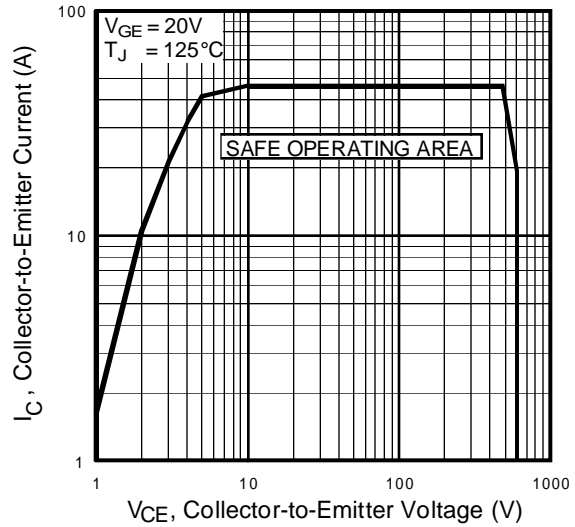
**Fig. 9 - Typical Switching Losses vs. Gate Resistance**



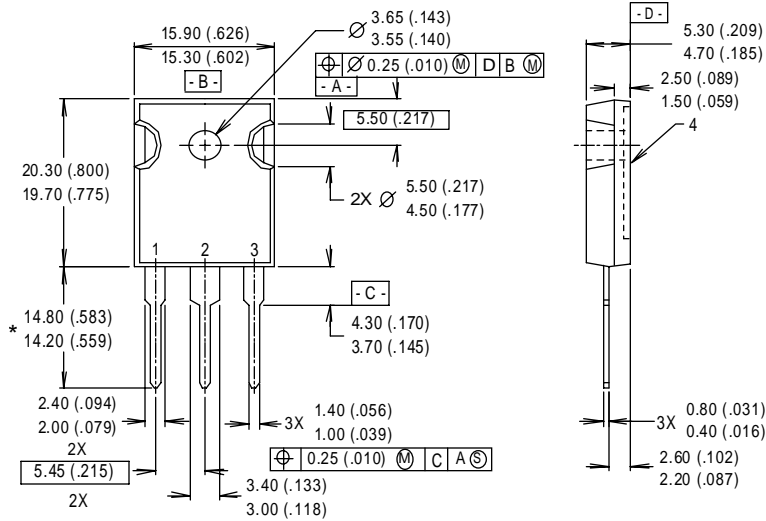
**Fig. 10 - Typical Switching Losses vs. Case Temperature**



**Fig. 11 - Typical Switching Losses vs. Collector-to-Emitter Current**



**Fig. 12 - Turn-Off SOA**

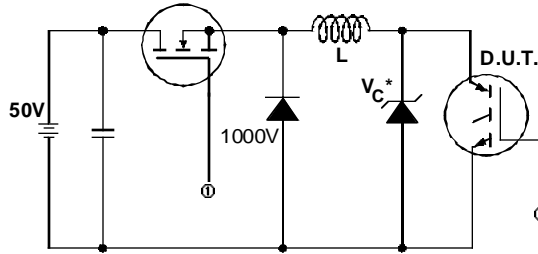


**NOTES:**  
 1 DIMENSIONS & TOLERANCING PER ANSI Y14.5M, 1982.  
 2 CONTROLLING DIMENSION : INCH.  
 3 DIMENSIONS ARE SHOWN MILLIMETERS (INCHES).  
 4 CONFORMS TO JEDEC OUTLINE TO-247AC.

**LEAD ASSIGNMENTS**  
 1 - GATE  
 2 - COLLECTOR  
 3 - EMITTER  
 4 - COLLECTOR

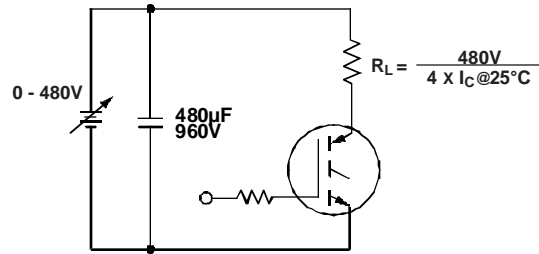
\* LONGER LEADED (20mm) VERSION AVAILABLE (TO-247AD) TO ORDER ADD "-E" SUFFIX TO PART NUMBER

**CONFORMS TO JEDEC OUTLINE TO-247AC (TO-3P)**  
 Dimensions in Millimeters and (Inches)

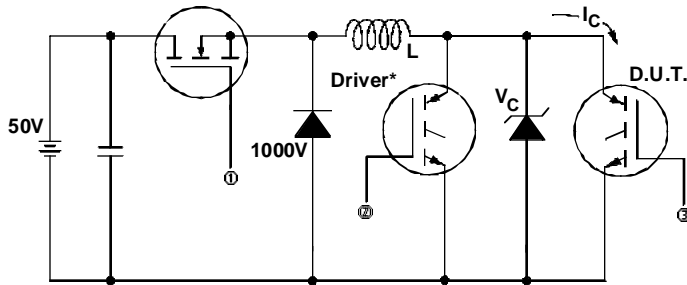


\* Driver same type as D.U.T.;  $V_c = 80\%$  of  $V_{ce(max)}$   
 \* Note: Due to the 50V power supply, pulse width and inductor will increase to obtain rated  $I_d$ .

**Fig. 13a** - Clamped Inductive Load Test Circuit

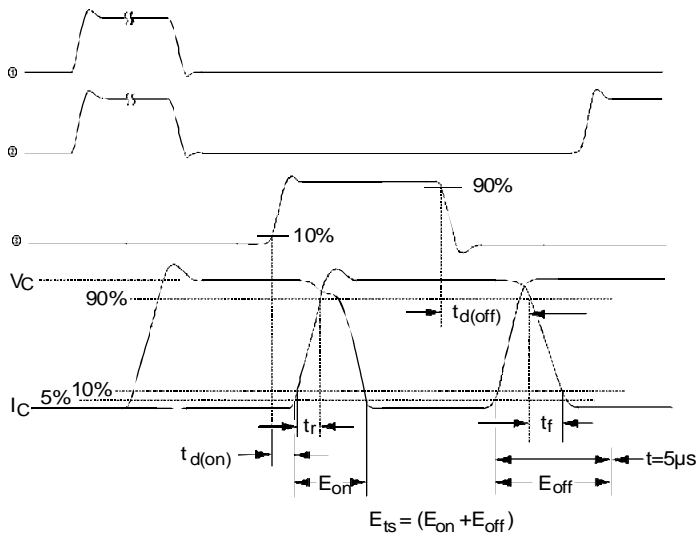


**Fig. 13b** - Pulsed Collector Current Test Circuit



**Fig. 14a** - Switching Loss Test Circuit

\* Driver same type as D.U.T.,  $V_C = 480V$



**Fig. 14b** - Switching Loss Waveforms