

<b>SANYO</b>	No.2425	<b>2SD1878</b>
		NPN Triple Diffused Planar Type Silicon Transistor
COLOR TV HORIZONTAL DEFLECTION OUTPUT APPLICATIONS		

**Applications**

- . Color TV horizontal deflection output
- . Color display horizontal deflection output

**Features**

- . High speed ( $t_f=100ns$  )
- . high breakdown voltage ( $V_{CBO}=1500V$ )
- . High reliability (adoption of HVP process)
- . On-chip damper diode

**Absolute Maximum Ratings at  $T_a=25^\circ C$**

			unit
Collector-to-Base Voltage	$V_{CBO}$	1500	V
Collector-to-Emitter Voltage	$V_{CEO}$	800	V
Emitter-to-Base Voltage	$V_{EBO}$	6	V
Collector Current	$I_C$	5	A
Peak Collector Current	$i_{cp}$	20	A
Collector Dissipation	$P_C$	60	W
Junction Temperature	$T_j$	150	$^\circ C$
Storage Temperature	$T_{stg}$	-55 to +150	$^\circ C$

**Electrical Characteristics at  $T_a=25^\circ C$**

			min	typ	max	unit
Collector Cutoff Current	$I_{CES}$	$V_{CE}=1500V$			1.0	mA
	$I_{CBO}$	$V_{CB}=800V$			10	$\mu A$
Collector Sustain Voltage	$V_{CEO}(sus)$	$I_C=100mA, I_B=0$	800			V
Emitter Cutoff Current	$I_{EBO}$	$V_{EB}=4V$	40		130	mA
C-E Saturation Voltage	$V_{CE}(sat)$	$I_C=4A, I_B=0.8A$			5	V
B-E Saturation Voltage	$V_{BE}(sat)$	$I_C=4A, I_B=0.8A$			1.5	V
DC Current Gain	$h_{FE1}$	$V_{CE}=5V, I_C=1A$	8			
	$h_{FE2}$	$V_{CE}=5V, I_C=4A$	5		10	
Diode Forward Voltage	$V_F$	$I_{EC}=5A$			2.0	V
Fall Time	$t_f$	$I_C=4A, I_{B1}=0.8A, I_{B2}=-1.6A$		0.1	0.3	$\mu s$

**Switching Time Test Circuit**

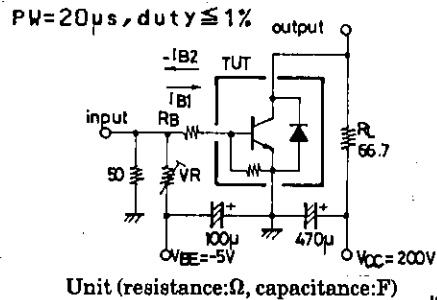

**Package Dimensions 2039 (unit:mm)**

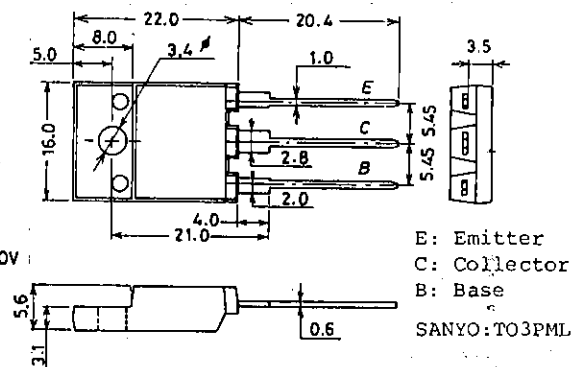

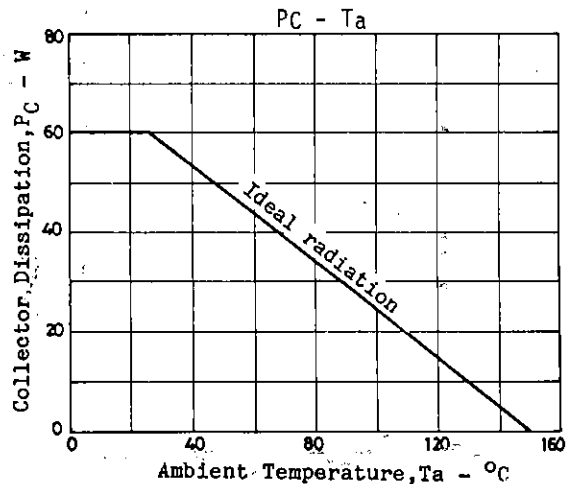
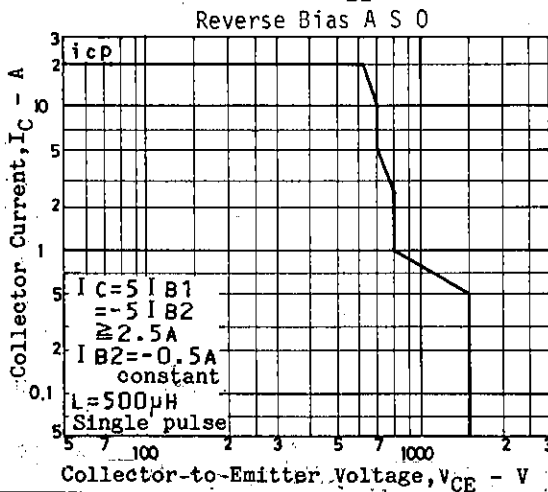
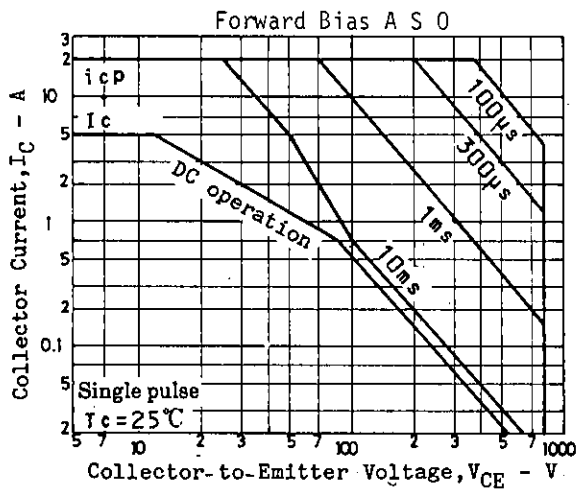
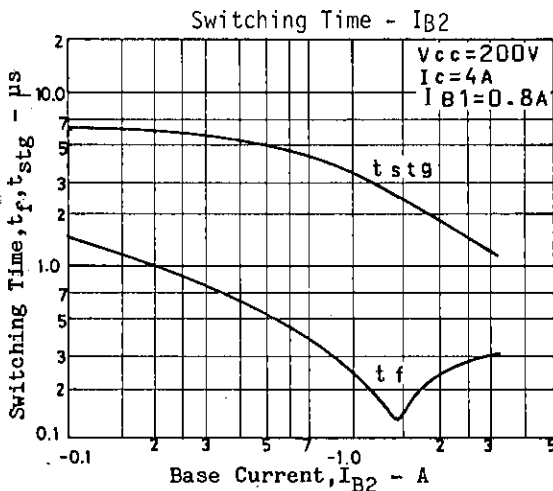
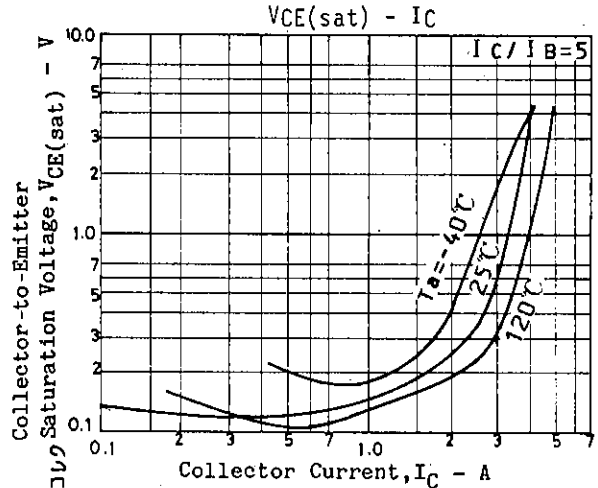
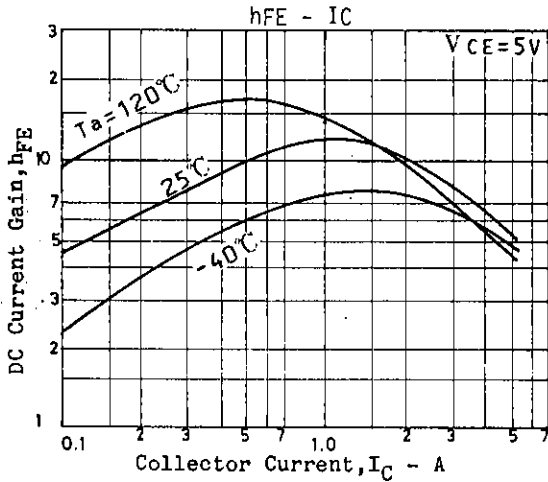
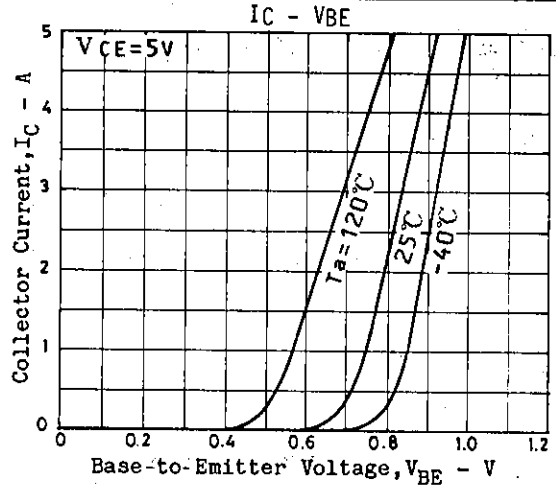
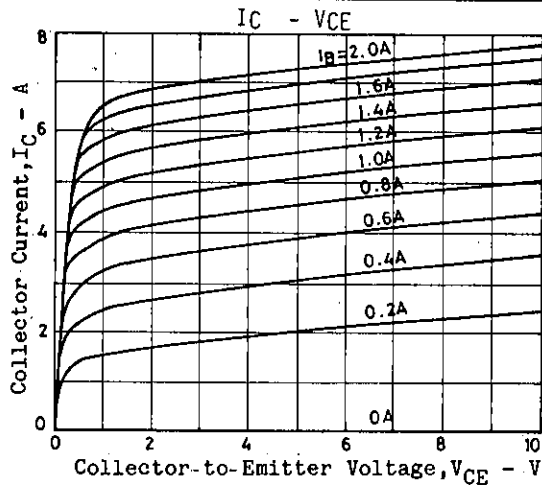

- No products described or contained herein are intended for use in surgical implants, life-support systems, aerospace equipment, nuclear power control systems, vehicles, disaster/crime-prevention equipment and the like, the failure of which may directly or indirectly cause injury, death or property loss.
- Anyone purchasing any products described or contained herein for an above-mentioned use shall:
  - ① Accept full responsibility and indemnify and defend SANYO ELECTRIC CO., LTD., its affiliates, subsidiaries and distributors and all their officers and employees, jointly and severally, against any and all claims and litigation and all damages, cost and expenses associated with such use:
  - ② Not impose any responsibility for any fault or negligence which may be cited in any such claim or litigation on SANYO ELECTRIC CO., LTD., its affiliates, subsidiaries and distributors or any of their officers and employees jointly or severally.
- Information (including circuit diagrams and circuit parameters) herein is for example only; it is not guaranteed for volume production. SANYO believes information herein is accurate and reliable, but no guarantees are made or implied regarding its use or any infringements of intellectual property rights or other rights of third parties.