

SINGLE SUPPLY QUAD COMPARATOR

■ GENERAL DESCRIPTION

The NJM12901 is single-supply quad voltage comparator, which can operate from 2V supply. The features are low input offset voltage, low input bias current and low current consumption. The NJM12901 compare the input signal to 0V (ground) due to the Darlington PNP input stage.

The package lineup is DIP, DMP and others compact, so that the NJM12901 is suitable for any kind of signal comparator.

■ PACKAGE OUTLINE

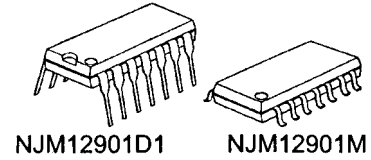

■ FEATURES

- Operating Voltage (+2V~+14V)
- Open Collector Output
- Bipolar Technology
- Package Outline DIP14,DMP14,EMP14,SSOP14

■ PIN CONFIGURATION

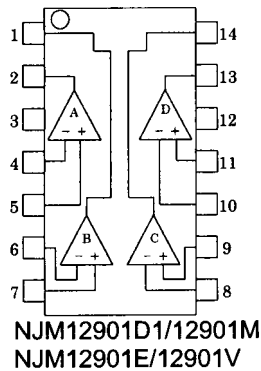

PIN FUNCTION

- | | |
|------------------|-------------|
| 1.B OUTPUT | 8.C -INPUT |
| 2.A OUTPUT | 9.C +INPUT |
| 3.V ⁺ | 10.D -INPUT |
| 4.A -INPUT | 11.D +INPUT |
| 5.A +INPUT | 12.GND |
| 6.B -INPUT | 13.D OUTPUT |
| 7.B +INPUT | 14.C OUTPUT |

■ EQUIVALENT CIRCUIT (1/4 Shown)

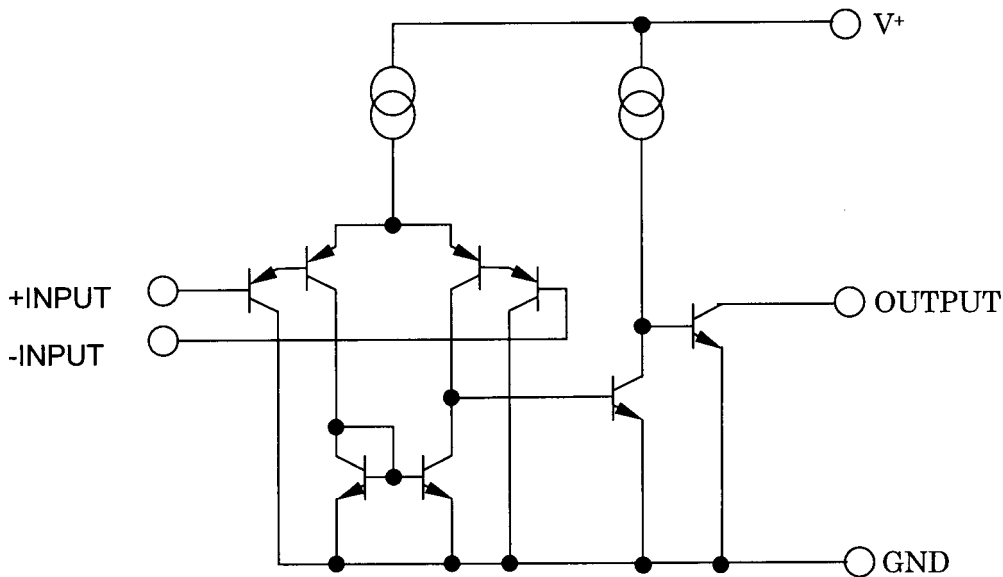

NJM12901

■ ABSOLUTE MAXIMUM RATINGS

(Ta=25°C)

PARAMETER	SYMBOL	RATINGS	UNIT
Supply Voltage	V^+	15	V
Differential Input Voltage	V_{ID}	14	V
Input Voltage	V_{IC}	-0.3~+14	V
Power Dissipation	P_D	(DIP14) 700 (DMP14) 300 (EMP14) 300 (SSOP14) 300	mW
Operating Temperature Range	T_{opr}	-40~+85	°C
Storage Temperature Range	T_{stg}	-50~+125	°C

■ ELECTRICAL CHARACTERISTICS

($V^+=5V, Ta=25^\circ C$)

PARAMETER	SYMBOL	TEST CONDITION	MIN.	TYP.	MAX.	UNIT
Operating Voltage	V_{opr}		2	-	14	V
Input Offset Voltage	V_{IO}	$R_S=0\Omega, V_O=1.4V$	-	1	4	mV
Input Offset Current	I_{IO}		-	5	50	nA
Input Bias Current	I_B		-	30	200	nA
Input Common Mode Voltage Range	V_{ICM}		0~3.5	-	-	V
Large Signal Voltage Gain	A_V	$R_L=15k\Omega$	-	106	-	dB
Response Time	t_R	$R_L=5.1k\Omega$	-	0.5	-	μs
Output Sink Current	I_{SINK}	$V_{IN}^-=1V, V_{IN}^+=0V, V_O=1.5V$	6	10	-	mA
Output Saturation Voltage	V_{SAT}	$V_{IN}^-=1V, V_{IN}^+=0V, I_{SINK}=3mA$	-	80	300	mV
Leakage Current	I_{LEAK}	$V_{IN}^-=0V, V_{IN}^+=1V, V_O=5V$	-	0.1	1.0	μA
Operating Current	I_{CC}	$R_L=\infty$	-	0.8	1.8	mA

■ TYPICAL CHARACTERISTICS

NJM12901 Operating Current vs. Operating Voltage

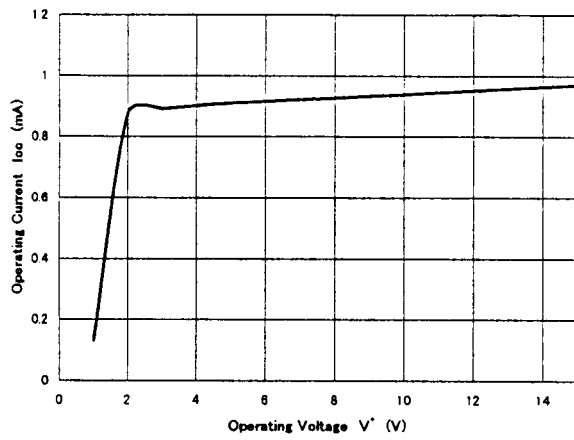

NJM12901 Output Saturation Voltage vs. Output sink Current

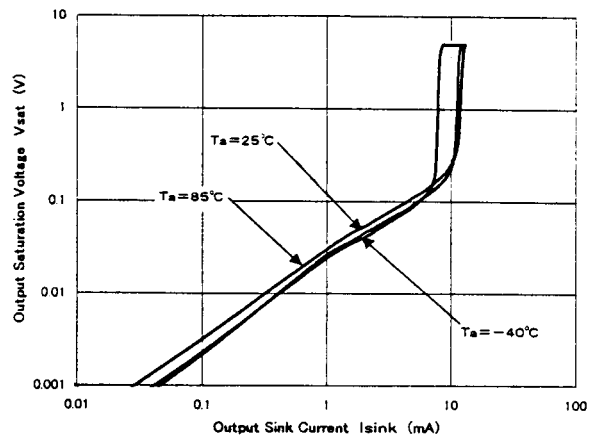

NJM12901 Input Offset Voltage vs. Operating Voltage

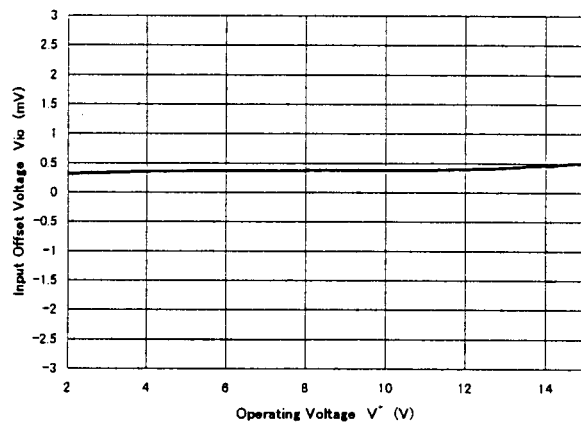

NJM12901 Input Bias Current vs. Operating Voltage

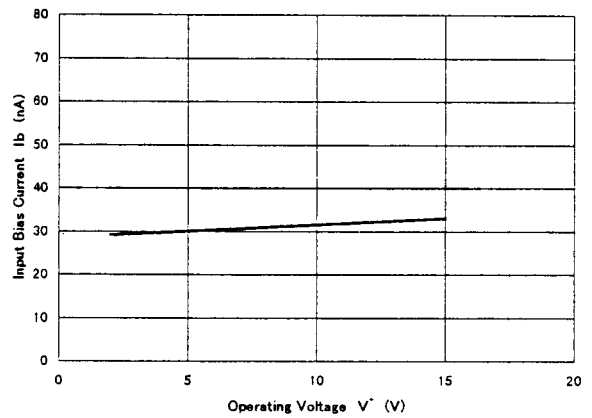

NJM12901 Output Saturation Voltage vs. Operating Voltage

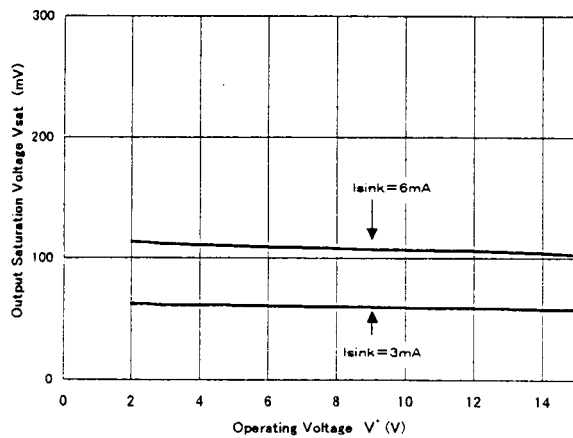

NJM12901 Input Common Mode Voltage Range

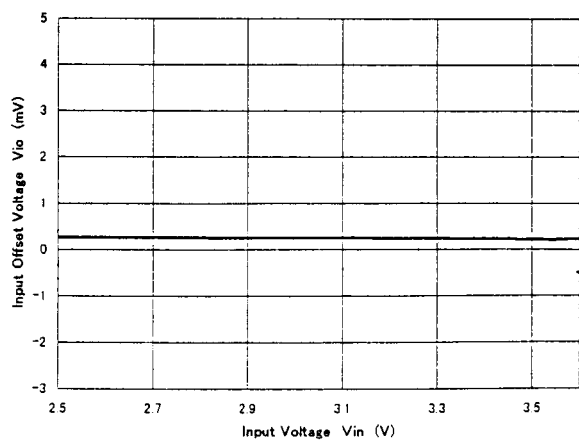

NJM12901

■ TYPICAL CHARACTERISTICS

NJM12901 Operating Current vs. Temperature

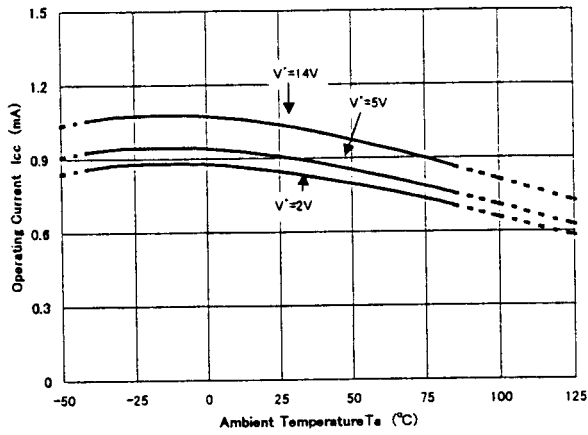

NJM12901 Input Bias Current vs. Temperature

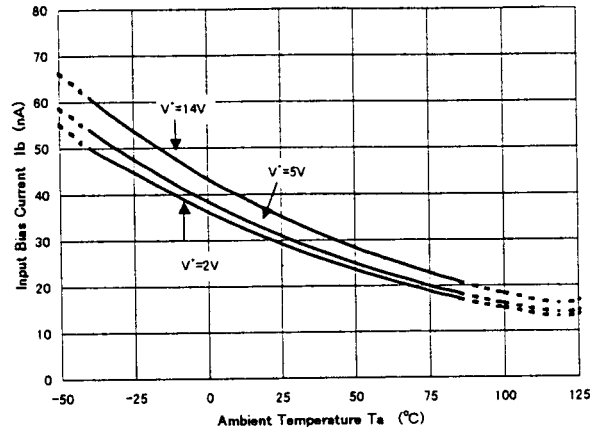

NJM12901 Input Offset Voltage vs. Temperature

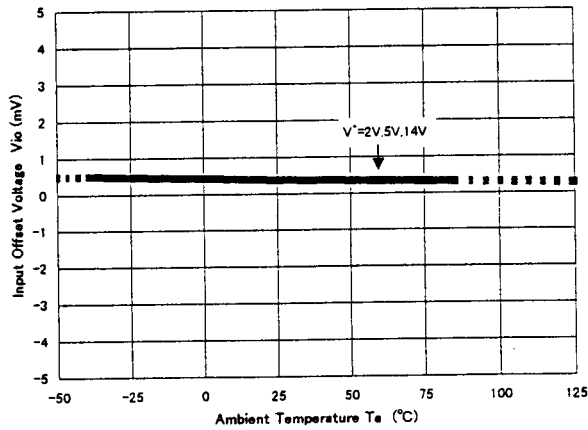

NJM12901 Output Saturation Voltage vs. Temperature
($I_{sink}=3mA$)

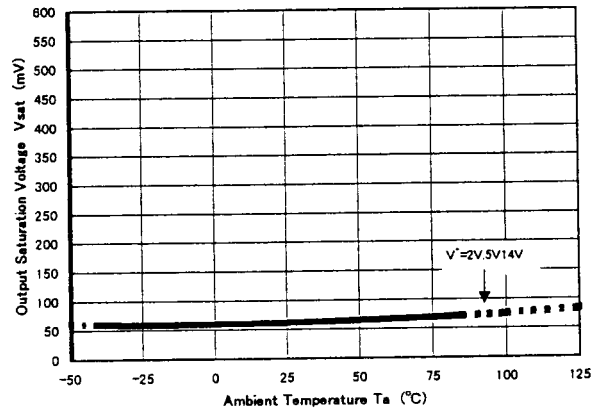

NJM12901 Pulse Response

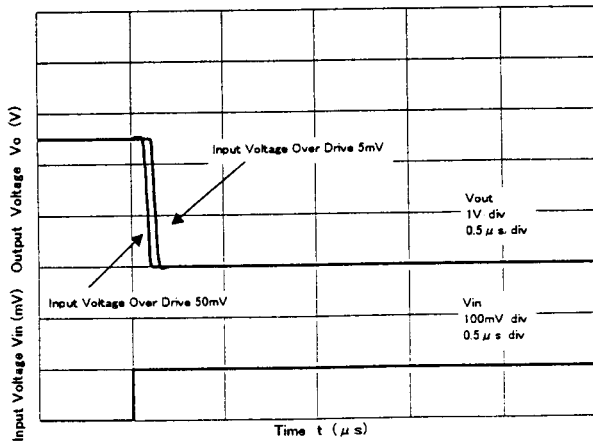

NJM12901 Pulse Response

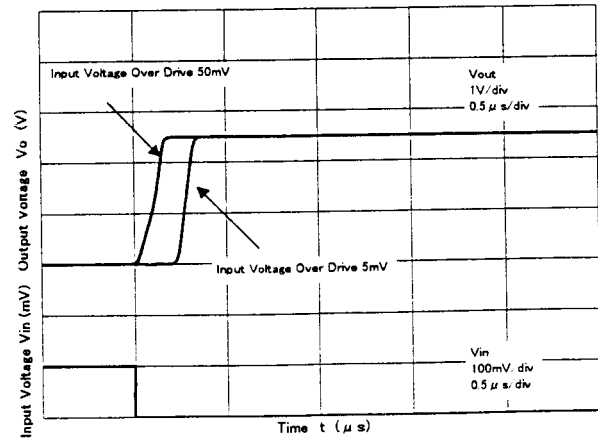

[CAUTION]

The specifications on this databook are only given for information, without any guarantee as regards either mistakes or omissions. The application circuits in this databook are described only to show representative usages of the product and not intended for the guarantee or permission of any right including the industrial rights.