

RF & MICROWAVE TRANSISTORS
108-152MHz APPLICATIONS

- FM CLASS C TRANSISTOR
- FREQUENCY 150MHz
- VOLTAGE 28V
- POWER OUT 10W
- POWER GAIN 10dB
- EFFICIENCY 55%TYP
- COMMON EMITTER

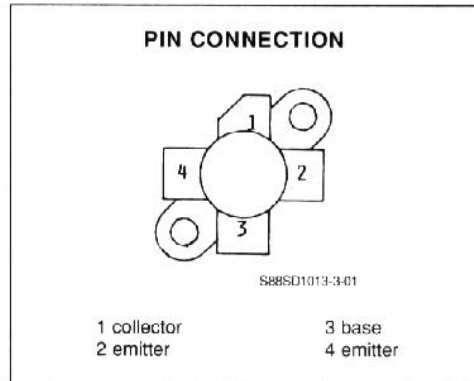
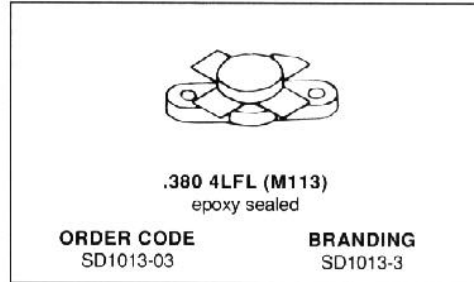

DESCRIPTION

The SD1013-3 is a 28V epitaxial silicon NPN planar transistor designed for 108-152 MHz FM applications.

This device utilizes diffused emitter resistors to achieve infinite VSWR at rated operating conditions.

ABSOLUTE MAXIMUM RATINGS ($T_{case} = 25^{\circ}C$)

Symbol	Parameter	Value	Unit
V_{CBO}	Collector - Base Voltage	65	V
V_{CEO}	Collector - Emitter Voltage	35	V
V_{CES}	Collector - Emitter Voltage	65	V
V_{EBO}	Emitter - Base Voltage	4	V
I_C	Collector Current	1	A
P_{tot}	Total Power Dissipation	13	W
T_{stg}	Storage Temperature	- 65 to 150	$^{\circ}C$
T_j	Junction Temperature	200	$^{\circ}C$

THERMAL DATA

$R_{th(j-c)}$	Junction-case Thermal Resistance	13.5	$^{\circ}C/W$
---------------	----------------------------------	------	---------------

SD1013-3

ELECTRICAL CHARACTERISTICS ($T_{case} = 25^{\circ}C$)

STATIC

Symbol	Test Conditions		Value			Unit
			Min.	Typ.	Max.	
BV_{CBO}	$I_C = 200mA$	$I_E = 0$	65			V
BV_{CES}	$I_C = 200mA$	$V_{BE} = 0$	65			V
BV_{CEO}	$I_C = 200mA$	$I_B = 0$	35			V
BV_{EBO}	$I_E = 10.0mA$	$I_C = 0$	4			V
I_{CBO}	$V_{CB} = 30.0V$	$I_E = 0$			1	mA
h_{FE}	$V_{CE} = 5.0V$	$I_C = 200mA$	5		200	

DYNAMIC

Symbol	Test Conditions			Value			Unit
				Min.	Typ.	Max.	
P_O	$f = 150MHz$	$V_{CC} = 28V$				10	W
G_P	$f = 150MHz$	$V_{CC} = 28V$				10	dB
C_{ob}	$f = 1MHz$	$V_{CB} = 30V$	$I_E = 0$			15	pF

When used $V_{CC} = 13.5V$ performances are :
 $P_{out} = 3.5Watt$ typical.
 $G_p = 10.5dB$ typical.

APPLICATION INFORMATION (typical curves)

POWER OUT VS POWER IN

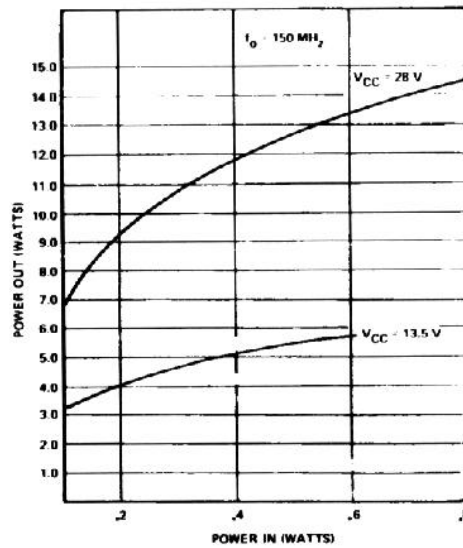

S88-SD1013-3-02

APPLICATION INFORMATION (typical curves)

POWER OUT VS FREQUENCY (13.5V, 28V)

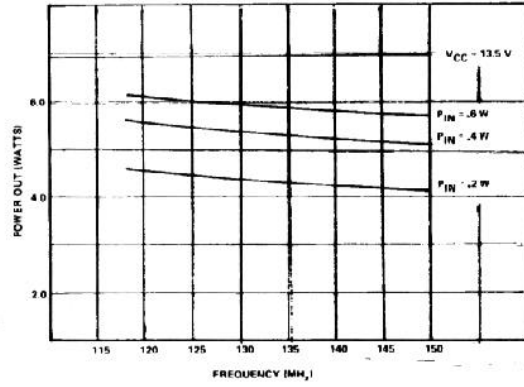

$V_{CC} = 13.5\text{ V}$
S88-SD1013-3-03

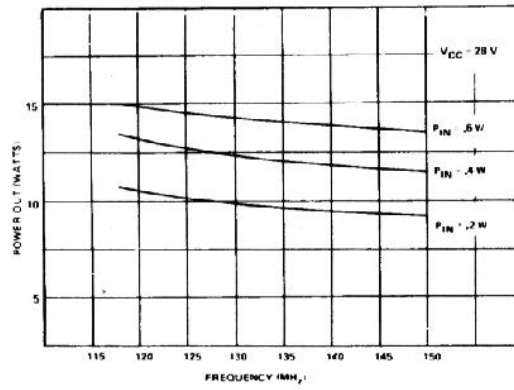

$V_{CC} = 28\text{ V}$
S88-SD1013-3-04

SD1013-3

IMPEDANCES DATAS (typical)

SERIES SOURCE IMPEDANCE VS FREQUENCY (13.5V, 28V)

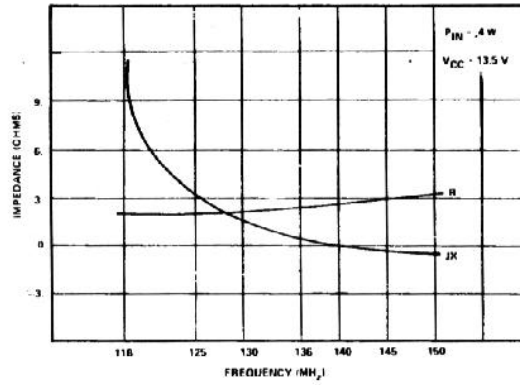

$V_{CC} = 13.5 V$

S88-SD1013-3-05

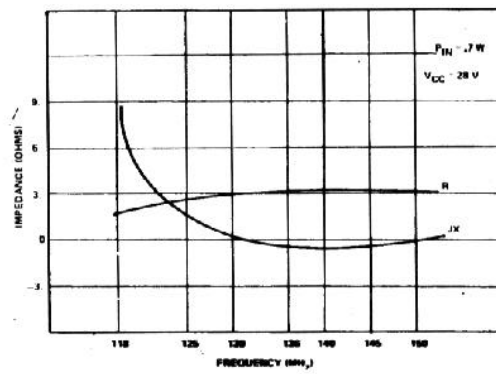

$V_{CC} = 28 V$

S88-SD1013-3-06

IMPEDANCES DATAS (typical)(continued)

SERIES COLLECTOR LOAD IMPEDANCE VS FREQUENCY (13.5V, 28V)

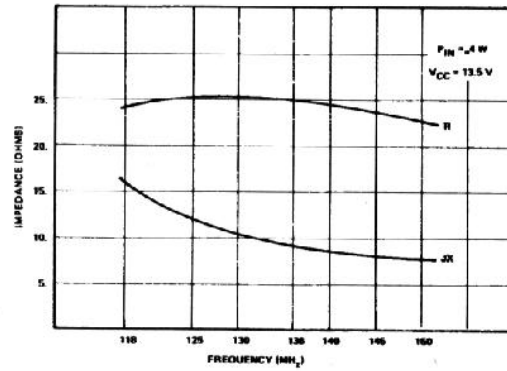
 $V_{CC} = 13.5 V$

S88-SD1013-3-07

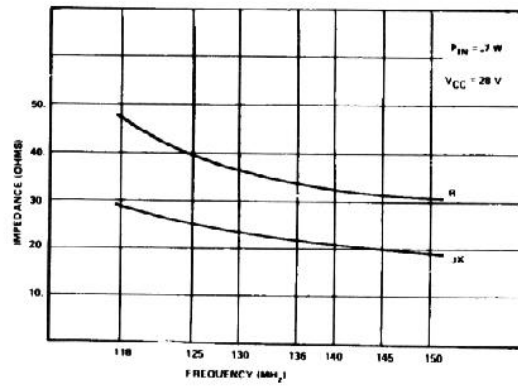
 $V_{CC} = 28 V$

S88-SD1013-3-08

TEST FIXTURE

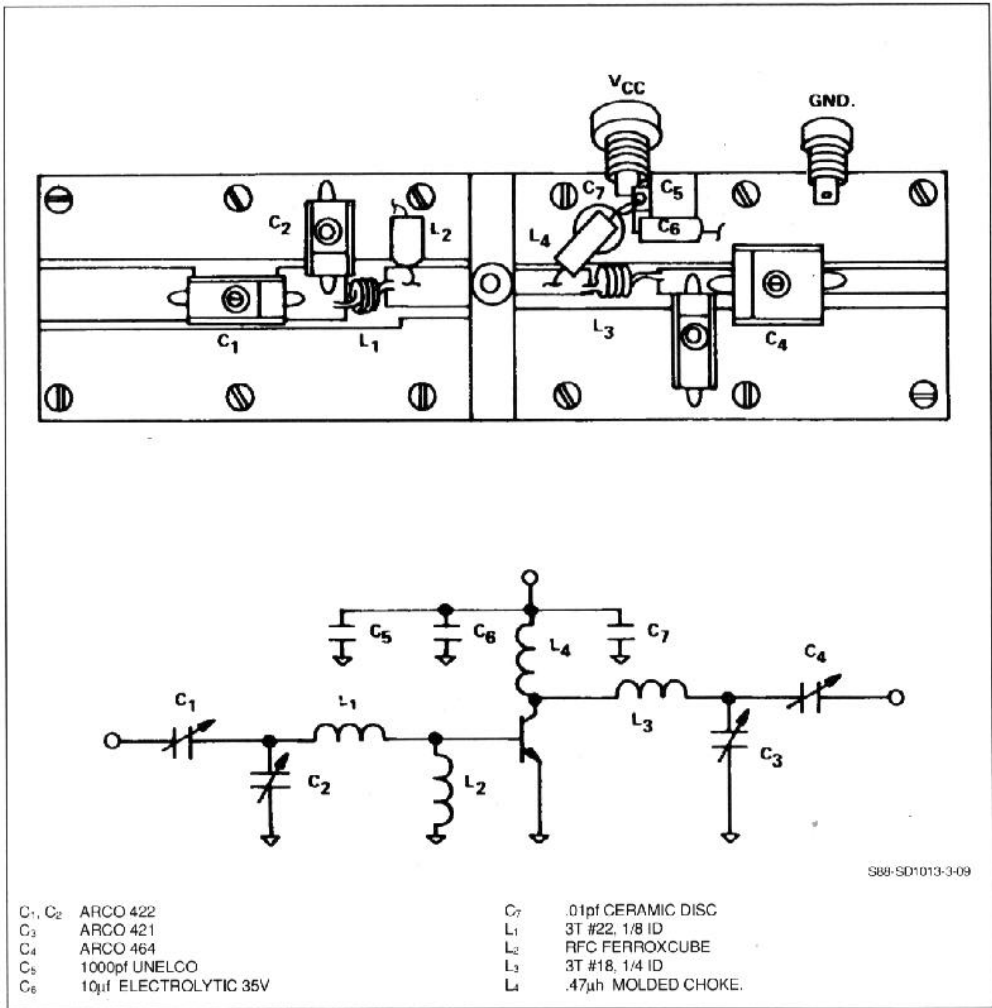

PACKAGE MECHANICAL DATA

380 4LFL

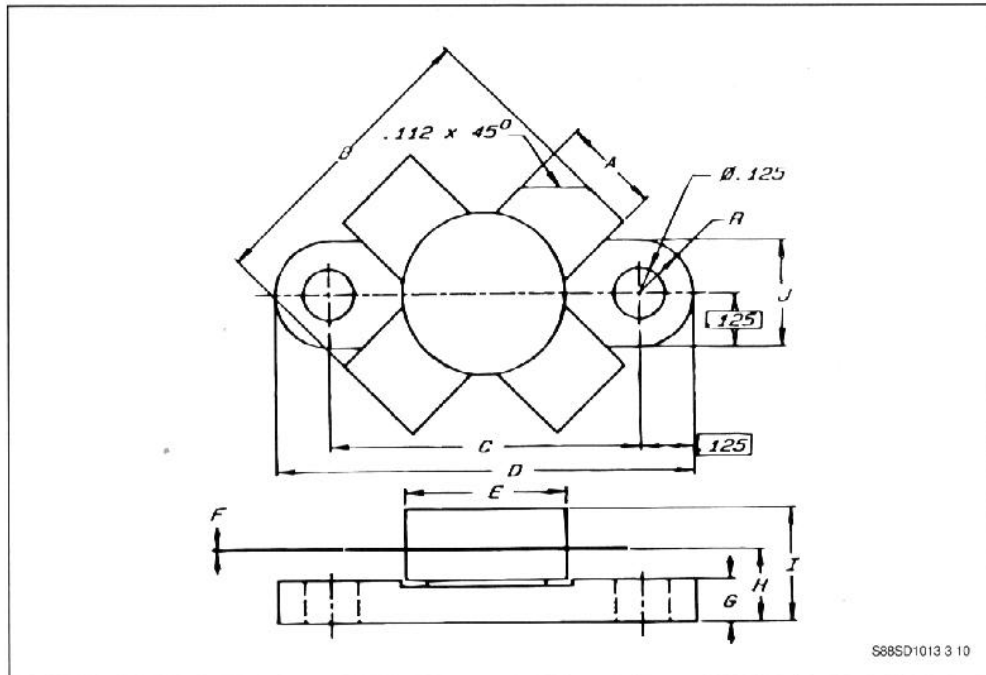

	Minimum Inches/mm	Maximum Inches/mm
A	.220/5.59	.230/5.84
B	.785/19.94	
C	.720/18.29	.730/18.54
D	.970/24.64	.980/24.89
E		.385/9.78
F	.004/0.10	.006/0.15
G	.085/2.16	.105/2.67
H	.160/4.06	.180/4.57
I		.280/7.11
J	.240/6.10	.255/6.48