

## 2A High-Speed MOSFET Drivers

### Features

- Latch-Up Protected: Will Withstand 500mA Reverse Current
- Input Will Withstand Negative Inputs Up to 5V
- ESD Protected: 4kV
- High Peak Output Current: 2A
- Wide Operating Range
  - 4.5V to 16V
- High Capacitive Load Drive Capability: 1000pF in 18nsec
- Short Delay Time: 35nsec Typ
- Consistent Delay Times With Changes in Supply Voltage
- Matched Delay Times
- Low Supply Current
  - With Logic "1" Input: 500 $\mu$ A
  - With Logic "0" Input: 100 $\mu$ A
- Low Output Impedance: 4 $\Omega$
- Pinout Same as TC1410/TC1411/TC1413

### Applications

- Switch Mode Power Supplies
- Pulse Transformer Drive
- Line Drivers
- Relay Driver

### Device Selection Table

Part Number	Package	Temp. Range
TC1412COA	8-Pin SOIC	0°C to +70°C
TC1412CPA	8-Pin PDIP	0°C to +70°C
TC1412EOA	8-Pin SOIC	-40°C to +85°C
TC1412EPA	8-Pin PDIP	-40°C to +85°C
TC1412NCOA	8-Pin SOIC	0°C to +70°C
TC1412NCPA	8-Pin PDIP	0°C to +70°C
TC1412NEOA	8-Pin SOIC	-40°C to +85°C
TC1412NEPA	8-Pin PDIP	-40°C to +85°C

### Package Type

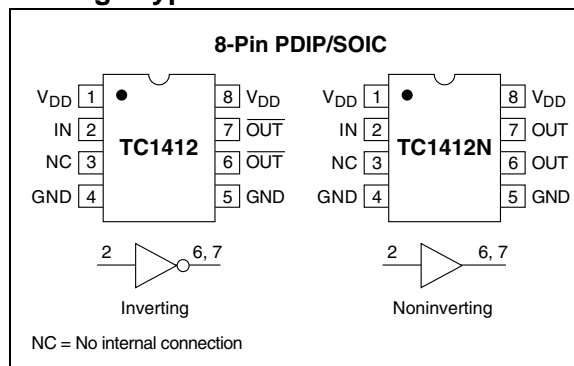

### General Description

The TC1412/TC1412N are 2A CMOS buffer/drivers. They will not latch up under any conditions within their power and voltage ratings. They are not subject to damage when up to 5V of noise spiking of either polarity occurs on the ground pin. They can accept, without damage or logic upset, up to 500mA of current of either polarity being forced back into their output. All terminals are fully protected against up to 4kV of electrostatic discharge.

As MOSFET drivers, the TC1412/TC1412N can easily charge a 1000pF gate capacitance in 18nsec with matched rise and fall times, and provide low enough impedance in both the ON and the OFF states to ensure the MOSFET's intended state will not be affected, even by large transients. The rise and fall time edges are matched to allow driving short-duration inputs with greater accuracy.

# TC1412/TC1412N

## Functional Block Diagram

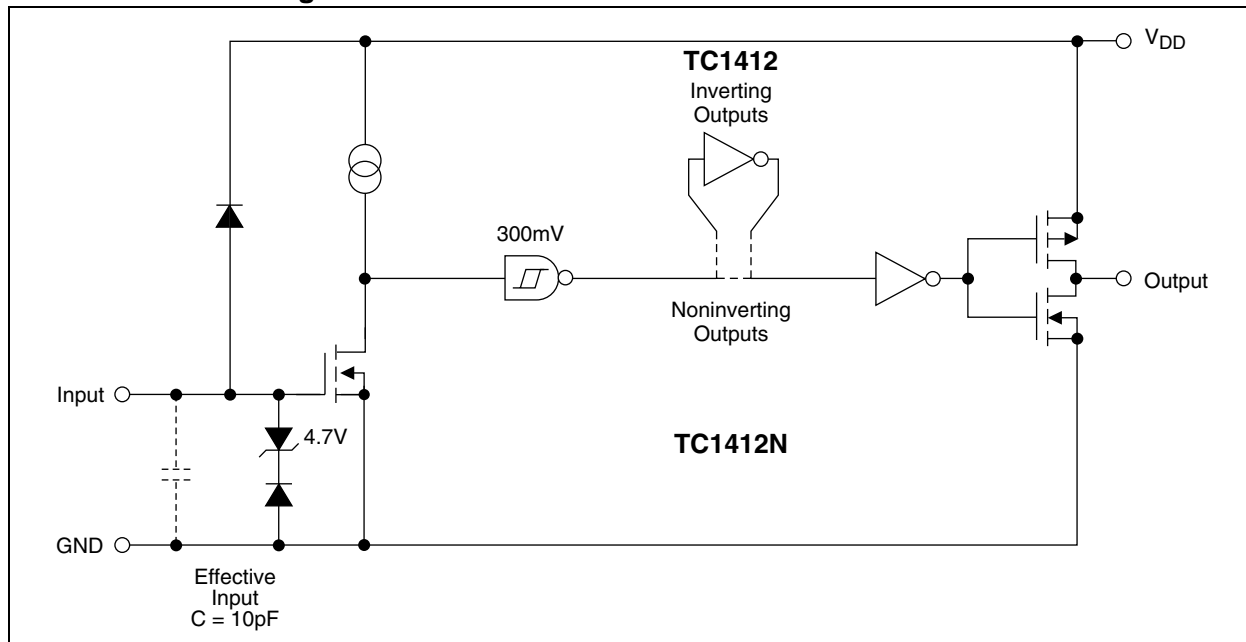

## 1.0 ELECTRICAL CHARACTERISTICS

### Absolute Maximum Ratings\*

Supply Voltage.....	+20V
Input Voltage.....	$V_{DD} + 0.3V$ to GND – 5.0V
Power Dissipation ( $T_A \leq 70^\circ C$ )	
PDIP .....	730mW
SOIC.....	470mW
Package Thermal Resistance	
PDIP $R_{\theta J-A}$ .....	125°C/W
PDIP $R_{\theta J-C}$ .....	42°C/W
SOIC $R_{\theta J-A}$ .....	155°C/W
SOIC $R_{\theta J-C}$ .....	45°C/W
Operating Temperature Range	
C Version.....	0°C to +70°C
E Version.....	-40°C to +85°C
Storage Temperature Range .....	-65°C to +150°C

\*Stresses above those listed under "Absolute Maximum Ratings" may cause permanent damage to the device. These are stress ratings only and functional operation of the device at these or any other conditions above those indicated in the operation sections of the specifications is not implied. Exposure to Absolute Maximum Rating conditions for extended periods may affect device reliability.

### TC1412/TC1412N ELECTRICAL SPECIFICATIONS

**Electrical Characteristics:** Over operating temperature range with  $4.5V \leq V_{DD} \leq 16V$ , unless otherwise noted. Typical values are measured at  $T_A = +25^\circ C$ ,  $V_{DD} = 16V$ .

Symbol	Parameter	Min	Typ	Max	Units	Test Conditions
<b>Input</b>						
$V_{IH}$	Logic 1, High Input Voltage	2.0	—	—	V	
$V_{IL}$	Logic 0, Low Input Voltage	—	—	0.8	V	
$I_{IN}$	Input Current	-1 -10	—	1 10	$\mu A$	$0V \leq V_{IN} \leq V_{DD}$ , $T_A = +25^\circ C$ $-40^\circ C \leq T_A \leq +85^\circ C$
<b>Output</b>						
$V_{OH}$	High Output Voltage	$V_{DD} - 0.025$	—	—	V	DC Test
$V_{OL}$	Low Output Voltage	—	—	0.025	V	DC Test
$R_O$	Output Resistance	—	4 5 5	6 7 7	$\Omega$	$V_{DD} = 16V$ , $I_O = 10mA$ , $T_A = +25^\circ C$ , $0^\circ C \leq T_A \leq +70^\circ C$ $-40^\circ C \leq T_A \leq +85^\circ C$
$I_{PK}$	Peak Output Current	—	2.0	—	A	$V_{DD} = 16V$
$I_{REV}$	Latch-Up Protection Withstand Reverse Current	—	0.5	—	A	Duty cycle $\leq 2\%$ , $t \leq 300\mu sec$ , $V_{DD} = 16V$

# TC1412/TC1412N

## TC1412/TC1412N ELECTRICAL SPECIFICATIONS (CONTINUED)

**Electrical Characteristics:** Over operating temperature range with  $4.5V \leq V_{DD} \leq 16V$ , unless otherwise noted. Typical values are measured at  $T_A = +25^\circ C$ ,  $V_{DD} = 16V$ .

Symbol	Parameter	Min	Typ	Max	Units	Test Conditions
<b>Switching Time (Note 1)</b>						
$t_R$	Rise Time	—	18 20 22	26 31 31	nsec	$T_A = +25^\circ C$ , $0^\circ C \leq T_A \leq +70^\circ C$ $-40^\circ C \leq T_A \leq +85^\circ C$ , Figure 3-2
$t_F$	Fall Time	—	18 20 22	26 31 31	nsec	$T_A = +25^\circ C$ , $0^\circ C \leq T_A \leq +70^\circ C$ $-40^\circ C \leq T_A \leq +85^\circ C$ , Figure 3-2
$t_{D1}$	Delay Time	—	35 40 40	45 50 50	nsec	$T_A = +25^\circ C$ , $0^\circ C \leq T_A \leq +70^\circ C$ $-40^\circ C \leq T_A \leq +85^\circ C$ , Figure 3-2
$t_{D2}$	Delay Time	—	35 40 40	45 50 50	nsec	$T_A = +25^\circ C$ , $0^\circ C \leq T_A \leq +70^\circ C$ $-40^\circ C \leq T_A \leq +85^\circ C$ , Figure 3-2
<b>Power Supply</b>						
$I_S$	Power Supply Current	— —	0.5 0.1	1.0 0.15	mA	$V_{IN} = 3V$ , $V_{DD} = 16V$ $V_{IN} = 0V$

**Note 1:** Switching times ensured by design.

## 2.0 PIN DESCRIPTIONS

The descriptions of the pins are listed in Table 2-1.

**TABLE 2-1: PIN FUNCTION TABLE**

Pin No. (8-Pin PDIP, SOIC)	Symbol	Description
1	$V_{DD}$	Supply input, 4.5V to 16V.
2	INPUT	Control input.
3	NC	No connection.
4	GND	Ground.
5	GND	Ground.
6	OUTPUT	CMOS totem-pole output, common to pin 7.
7	OUTPUT	CMOS totem-pole output, common to pin 6.
8	$V_{DD}$	Supply Input, 4.5V to 16V.

# TC1412/TC1412N

## 3.0 APPLICATIONS INFORMATION

FIGURE 3-1: THERMAL DERATING CURVE

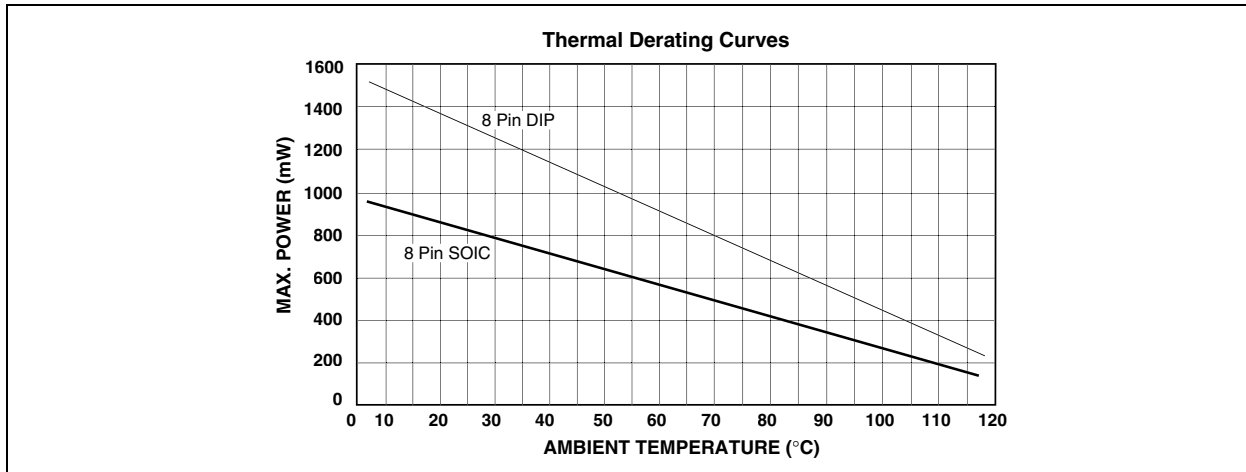
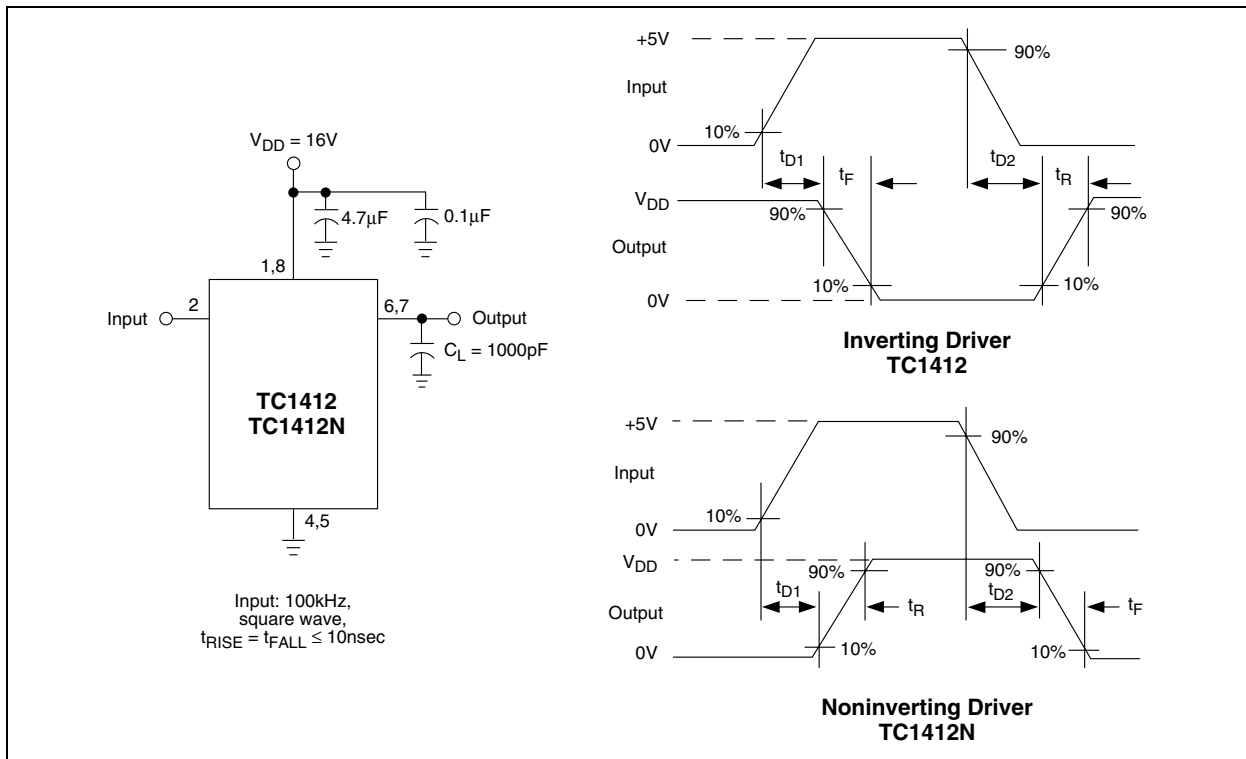
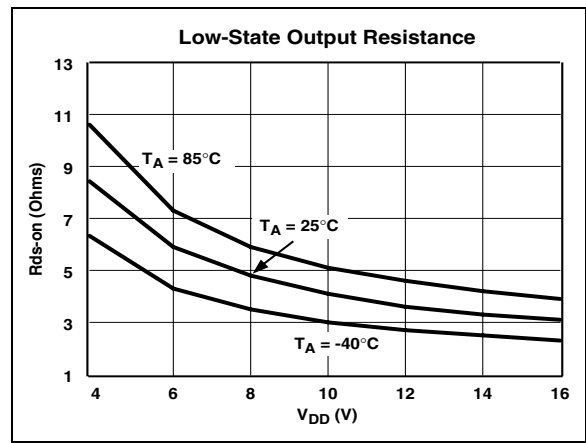
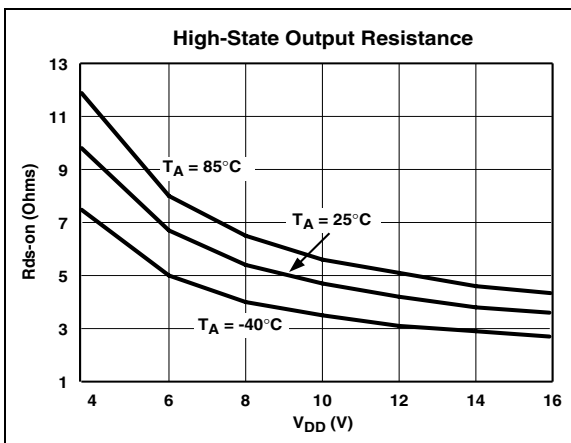
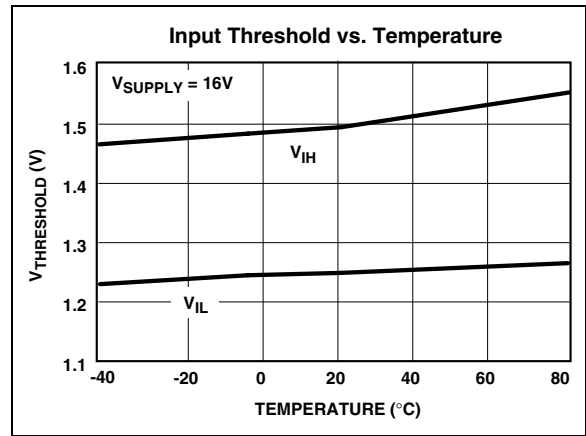
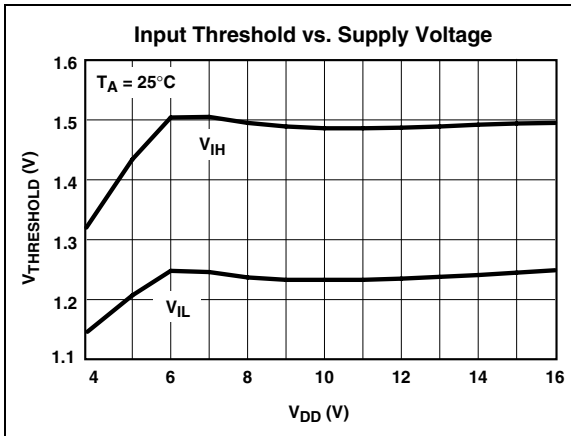
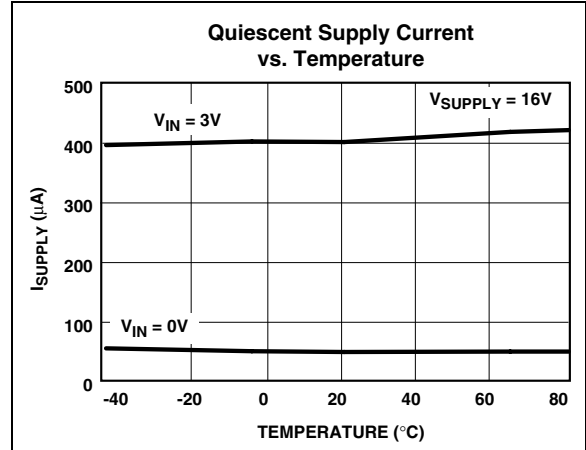
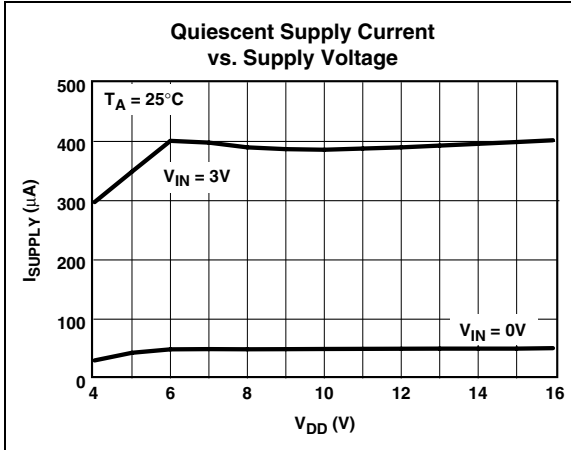

FIGURE 3-2: SWITCHING TIME TEST CIRCUIT



## 4.0 TYPICAL CHARACTERISTICS

**Note:** The graphs and tables provided following this note are a statistical summary based on a limited number of samples and are provided for informational purposes only. The performance characteristics listed herein are not tested or guaranteed. In some graphs or tables, the data presented may be outside the specified operating range (e.g., outside specified power supply range) and therefore outside the warranted range.



# TC1412/TC1412N

## TYPICAL CHARACTERISTICS (CONTINUED)

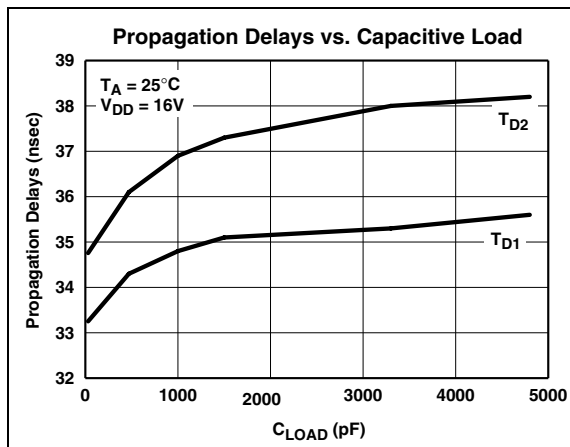
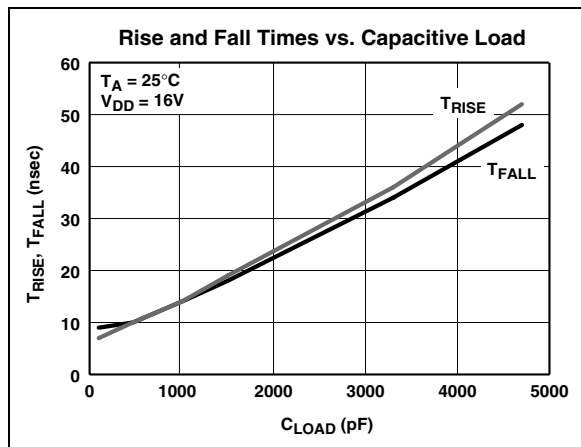
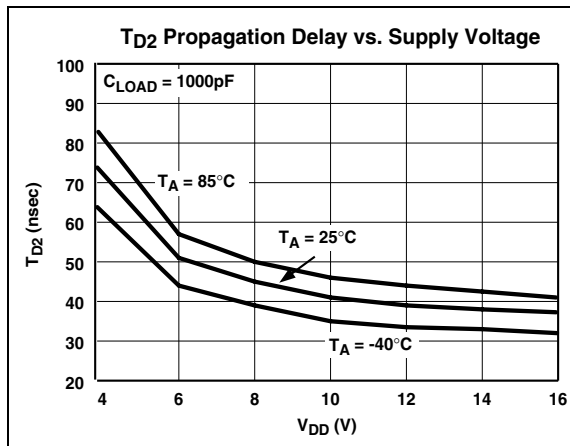
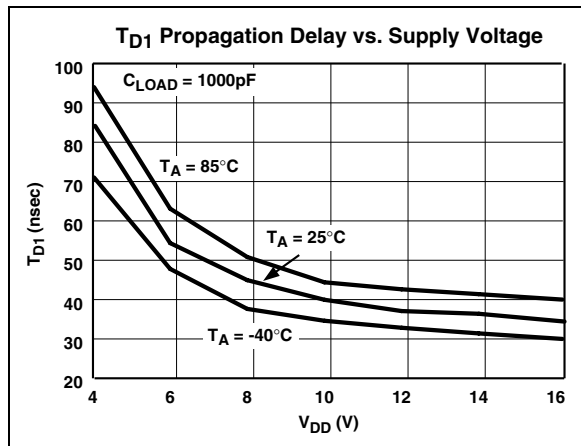
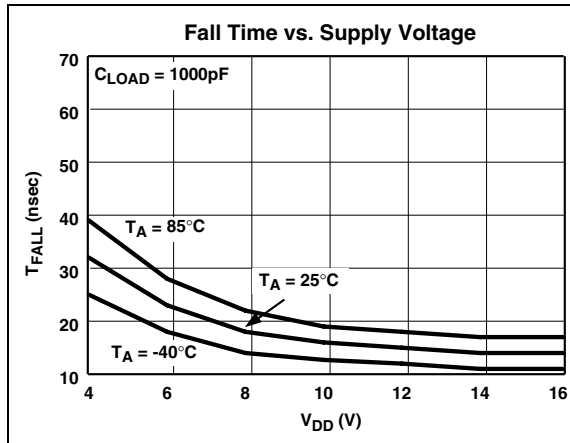
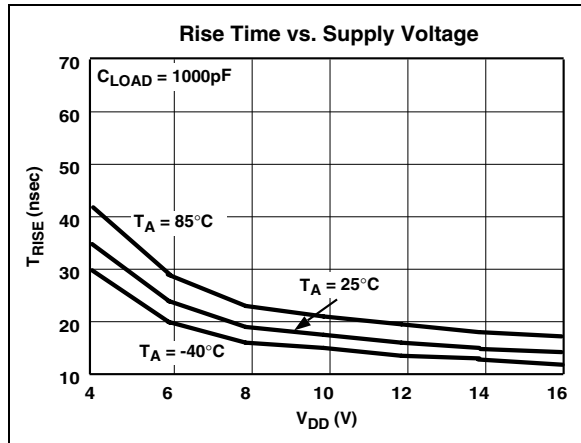



## 5.0 PACKAGING INFORMATION

### 5.1 Package Marking Information

Package marking data not available at this time.

### 5.2 Package Dimensions

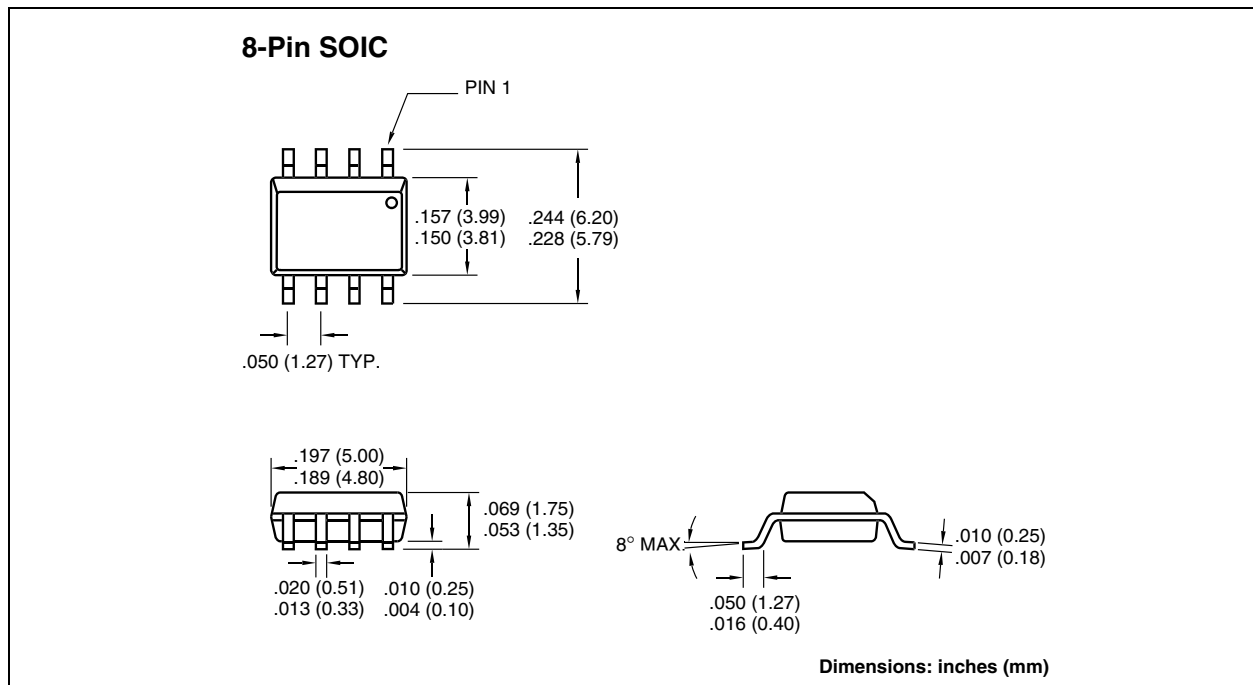
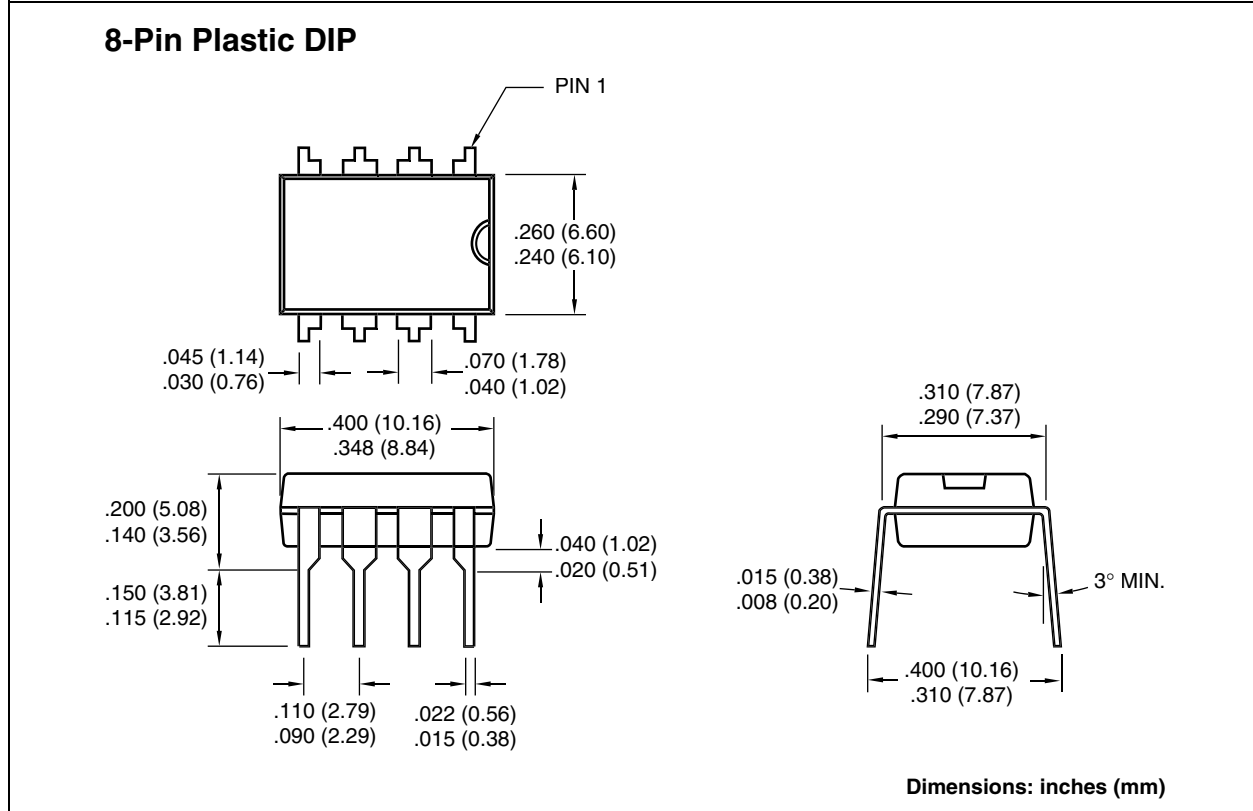

# TC1412/TC1412N

---

---

NOTES:

## **Sales and Support**

### **Data Sheets**

Products supported by a preliminary Data Sheet may have an errata sheet describing minor operational differences and recommended workarounds. To determine if an errata sheet exists for a particular device, please contact one of the following:

1. Your local Microchip sales office
2. The Microchip Corporate Literature Center U.S. FAX: (480) 792-7277
3. The Microchip Worldwide Site ([www.microchip.com](http://www.microchip.com))

Please specify which device, revision of silicon and Data Sheet (include Literature #) you are using.

### **New Customer Notification System**

Register on our web site ([www.microchip.com/cn](http://www.microchip.com/cn)) to receive the most current information on our products.

# TC1412/TC1412N

---

---

NOTES:

Information contained in this publication regarding device applications and the like is intended through suggestion only and may be superseded by updates. It is your responsibility to ensure that your application meets with your specifications. No representation or warranty is given and no liability is assumed by Microchip Technology Incorporated with respect to the accuracy or use of such information, or infringement of patents or other intellectual property rights arising from such use or otherwise. Use of Microchip's products as critical components in life support systems is not authorized except with express written approval by Microchip. No licenses are conveyed, implicitly or otherwise, under any intellectual property rights.

## Trademarks

The Microchip name and logo, the Microchip logo, FilterLab, KEELOQ, microID, MPLAB, PIC, PICmicro, PICMASTER, PICSTART, PRO MATE, SEEVAL and The Embedded Control Solutions Company are registered trademarks of Microchip Technology Incorporated in the U.S.A. and other countries.

dsPIC, ECONOMONITOR, FanSense, FlexROM, fuzzyLAB, In-Circuit Serial Programming, ICSP, ICEPIC, microPort, Migratable Memory, MPASM, MPLIB, MPLINK, MPSIM, MXDEV, PICC, PICDEM, PICDEM.net, rfPIC, Select Mode and Total Endurance are trademarks of Microchip Technology Incorporated in the U.S.A.

Serialized Quick Turn Programming (SQTP) is a service mark of Microchip Technology Incorporated in the U.S.A.

All other trademarks mentioned herein are property of their respective companies.

© 2002, Microchip Technology Incorporated, Printed in the U.S.A., All Rights Reserved.

 Printed on recycled paper.

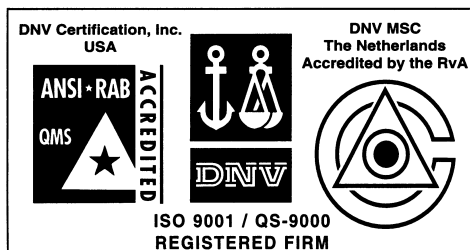

*Microchip received QS-9000 quality system certification for its worldwide headquarters, design and wafer fabrication facilities in Chandler and Tempe, Arizona in July 1999 and Mountain View, California in March 2002. The Company's quality system processes and procedures are QS-9000 compliant for its PICmicro® 8-bit MCUs, KEELOQ® code hopping devices, Serial EEPROMs, microperipherals, non-volatile memory and analog products. In addition, Microchip's quality system for the design and manufacture of development systems is ISO 9001 certified.*



# MICROCHIP

## WORLDWIDE SALES AND SERVICE

### AMERICAS

#### Corporate Office

2355 West Chandler Blvd.  
Chandler, AZ 85224-6199  
Tel: 480-792-7200 Fax: 480-792-7277  
Technical Support: 480-792-7627  
Web Address: <http://www.microchip.com>

#### Rocky Mountain

2355 West Chandler Blvd.  
Chandler, AZ 85224-6199  
Tel: 480-792-7966 Fax: 480-792-7456

#### Atlanta

500 Sugar Mill Road, Suite 200B  
Atlanta, GA 30350  
Tel: 770-640-0034 Fax: 770-640-0307

#### Boston

2 Lan Drive, Suite 120  
Westford, MA 01886  
Tel: 978-692-3848 Fax: 978-692-3821

#### Chicago

333 Pierce Road, Suite 180  
Itasca, IL 60143  
Tel: 630-285-0071 Fax: 630-285-0075

#### Dallas

4570 Westgrove Drive, Suite 160  
Addison, TX 75001  
Tel: 972-818-7423 Fax: 972-818-2924

#### Detroit

Tri-Atria Office Building  
32255 Northwestern Highway, Suite 190  
Farmington Hills, MI 48334  
Tel: 248-538-2250 Fax: 248-538-2260

#### Kokomo

2767 S. Albright Road  
Kokomo, Indiana 46902  
Tel: 765-864-8360 Fax: 765-864-8387

#### Los Angeles

18201 Von Karman, Suite 1090  
Irvine, CA 92612  
Tel: 949-263-1888 Fax: 949-263-1338

#### New York

150 Motor Parkway, Suite 202  
Hauppauge, NY 11788  
Tel: 631-273-5305 Fax: 631-273-5335

#### San Jose

Microchip Technology Inc.  
2107 North First Street, Suite 590  
San Jose, CA 95131  
Tel: 408-436-7950 Fax: 408-436-7955

#### Toronto

6285 Northam Drive, Suite 108  
Mississauga, Ontario L4V 1X5, Canada  
Tel: 905-673-0699 Fax: 905-673-6509

### ASIA/PACIFIC

#### Australia

Microchip Technology Australia Pty Ltd  
Suite 22, 41 Rawson Street  
Epping 2121, NSW  
Australia  
Tel: 61-2-9868-6733 Fax: 61-2-9868-6755

#### China - Beijing

Microchip Technology Consulting (Shanghai)  
Co., Ltd., Beijing Liaison Office  
Unit 915  
Bei Hai Wan Tai Bldg.  
No. 6 Chaoyangmen Beidajie  
Beijing, 100027, No. China  
Tel: 86-10-85282100 Fax: 86-10-85282104

#### China - Chengdu

Microchip Technology Consulting (Shanghai)  
Co., Ltd., Chengdu Liaison Office  
Rm. 2401, 24th Floor,  
Ming Xing Financial Tower  
No. 88 TIDU Street  
Chengdu 610016, China  
Tel: 86-28-6766200 Fax: 86-28-6766599

#### China - Fuzhou

Microchip Technology Consulting (Shanghai)  
Co., Ltd., Fuzhou Liaison Office  
Unit 28F, World Trade Plaza  
No. 71 Wusi Road  
Fuzhou 350001, China  
Tel: 86-591-7503506 Fax: 86-591-7503521

#### China - Shanghai

Microchip Technology Consulting (Shanghai)  
Co., Ltd.  
Room 701, Bldg. B  
Far East International Plaza  
No. 317 Xian Xia Road  
Shanghai, 200051  
Tel: 86-21-6275-5700 Fax: 86-21-6275-5060

#### China - Shenzhen

Microchip Technology Consulting (Shanghai)  
Co., Ltd., Shenzhen Liaison Office  
Rm. 1315, 13/F, Shenzhen Kerry Centre,  
Renminnan Lu  
Shenzhen 518001, China  
Tel: 86-755-2350361 Fax: 86-755-2366086

#### Hong Kong

Microchip Technology Hongkong Ltd.  
Unit 901-6, Tower 2, Metroplaza  
223 Hing Fong Road  
Kwai Fong, N.T., Hong Kong  
Tel: 852-2401-1200 Fax: 852-2401-3431

#### India

Microchip Technology Inc.  
India Liaison Office  
Divyasree Chambers  
1 Floor, Wing A (A3/A4)  
No. 11, O'Shaugnessey Road  
Bangalore, 560 025, India  
Tel: 91-80-2290061 Fax: 91-80-2290062

### Japan

Microchip Technology Japan K.K.  
Benex S-1 6F  
3-18-20, Shinyokohama  
Kohoku-Ku, Yokohama-shi  
Kanagawa, 222-0033, Japan  
Tel: 81-45-471- 6166 Fax: 81-45-471-6122

### Korea

Microchip Technology Korea  
168-1, Youngbo Bldg. 3 Floor  
Samsung-Dong, Kangnam-Ku  
Seoul, Korea 135-882  
Tel: 82-2-554-7200 Fax: 82-2-558-5934

### Singapore

Microchip Technology Singapore Pte Ltd.  
200 Middle Road  
#07-02 Prime Centre  
Singapore, 188980  
Tel: 65-6334-8870 Fax: 65-6334-8850

### Taiwan

Microchip Technology Taiwan  
11F-3, No. 207  
Tung Hua North Road  
Taipei, 105, Taiwan  
Tel: 886-2-2717-7175 Fax: 886-2-2545-0139

### EUROPE

#### Denmark

Microchip Technology Nordic ApS  
Regus Business Centre  
Lautrup høj 1-3  
Ballerup DK-2750 Denmark  
Tel: 45 4420 9895 Fax: 45 4420 9910

#### France

Microchip Technology SARL  
Parc d'Activite du Moulin de Massy  
43 Rue du Saule Trapu  
Batiment A - 1er Etage  
91300 Massy, France  
Tel: 33-1-69-53-63-20 Fax: 33-1-69-30-90-79

#### Germany

Microchip Technology GmbH  
Gustav-Heinemann Ring 125  
D-81739 Munich, Germany  
Tel: 49-89-627-144 0 Fax: 49-89-627-144-44

#### Italy

Microchip Technology SRL  
Centro Direzionale Colleoni  
Palazzo Taurus 1 V. Le Colleoni 1  
20041 Agrate Brianza  
Milan, Italy  
Tel: 39-039-65791-1 Fax: 39-039-6899883

#### United Kingdom

Arizona Microchip Technology Ltd.  
505 Eskdale Road  
Winnersh Triangle  
Wokingham  
Berkshire, England RG41 5TU  
Tel: 44 118 921 5869 Fax: 44-118 921-5820

03/01/02

