

Preliminary Data

Features

- Output voltage: 3.3 V/2.5 V \pm 4 %
- Very low current consumption
- Short-circuit proof
- Reverse polarity proof
- Suitable for use in automotive electronics

Type	Ordering Code	Package
TLE 4274 GSV 33	Q67006-A9289	P-SOT223-4-1
▼ TLE 4274 DV 33	Q67006-A9348	P-TO252-3-1
▼ TLE 4274 GSV 25	Q67006-A9359	P-SOT223-4-1

■ SMD = Surface Mounted Device

▼ New type

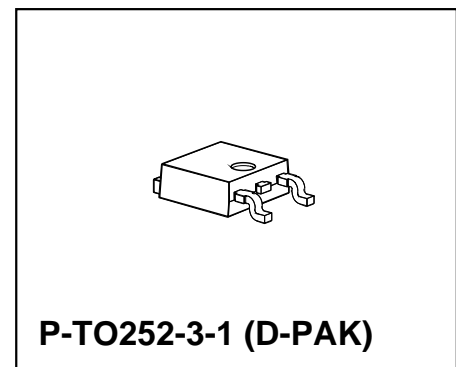
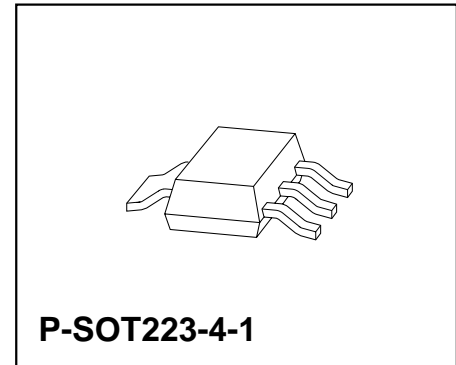

Functional Description

The TLE 4274 is a voltage regulator available in a SOT223 and TO252 package. The IC regulates an input voltage up to 40 V to $V_{Qrated} = 3.3 \text{ V}/2.5 \text{ V}$. The maximum output current is 400 mA. The IC is short-circuit proof and incorporates temperature protection that disables the IC at over temperature.

Dimensioning Information on External Components

The input capacitor C_1 is necessary for compensating line influences. Using a resistor of approx. 1 Ω in series with C_1 , the oscillating of input inductivity and input capacitance can be damped. The output capacitor C_Q is necessary for the stability of the regulation circuit. Stability is guaranteed at values $C_Q \geq 10 \mu\text{F}$ and an ESR of $\leq 3 \Omega$ within the operating temperature range.

Circuit Description

The control amplifier compares a reference voltage to a voltage that is proportional to the output voltage and drives the base of the series transistor via a buffer. Saturation control as a function of the load current prevents any oversaturation of the power element. The IC also incorporates a number of internal circuits for protection against:

- Overload,
- Overtemperature,
- Reverse polarity.

Pin Configuration

(top view)

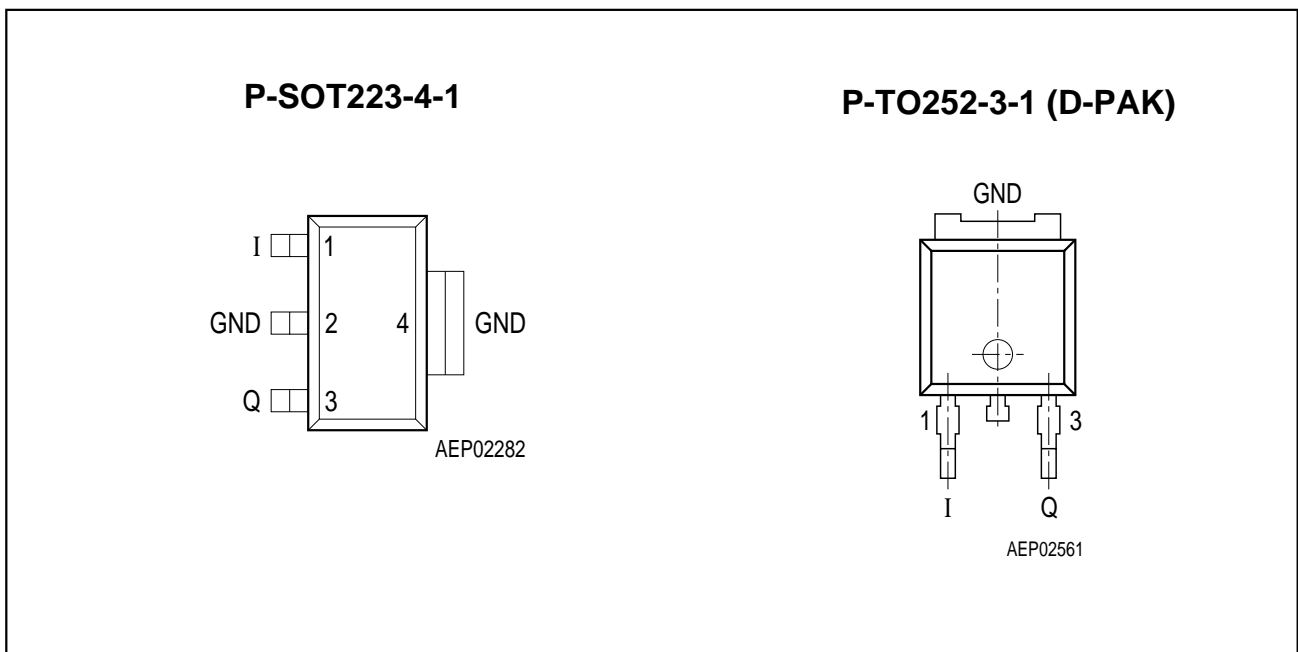

Figure 1

Pin Definitions and Functions

Pin No.	Symbol	Function
1	I	Input; block to ground directly at the IC with a ceramic capacitor.
2, 4	GND	Ground; P-TO252-3-1: internally connected to heatsink
3	Q	Output; block to ground with capacitor $C_Q \geq 10 \mu\text{F}$

Absolute Maximum Ratings $T_j = -40$ to 150 °C

Parameter	Symbol	Limit Values		Unit	Test Condition
		min.	max.		

Voltage Regulator**Input**

Voltage	V_I	- 42	45	V	-
Current	I_I	-	-	-	Internally limited

Output

Voltage	V_Q	- 1.0	40	V	-
Current	I_Q	-	-	-	Internally limited

Ground

Current	I_{GND}	-	100	mA	-
---------	-----------	---	-----	----	---

Temperature

Junction temperature	T_j	-	150	°C	-
Storage temperature	T_{stg}	- 50	150	°C	-

Note: Maximum ratings are absolute ratings; exceeding any one of these values may cause irreversible damage to the integrated circuit.

Operating Range

Parameter	Symbol	Limit Values		Unit	Remarks
		min.	max.		
Input voltage	V_I	4.7 4.0	40 40	V	V33 version V25 version
Junction temperature	T_j	- 40	150	°C	-

Thermal Resistance

Junction ambient	R_{thja}	-	100	K/W	SOT223 ¹⁾
Junction ambient	R_{thja}	-	70	K/W	TO252 ²⁾
Junction case	R_{thjc}	-	25	K/W	SOT223
Junction case	R_{thjc}	-	4	K/W	TO252

¹⁾ soldered in, 1 cm² copper area at pin 4, FR4

²⁾ soldered in, minimal footprint, FR4

Characteristics

$V_I = 6 \text{ V}$; $-40 \text{ }^\circ\text{C} < T_j < 150 \text{ }^\circ\text{C}$ (unless otherwise specified)

Parameter	Symbol	Limit Values			Unit	Measuring Condition
		min.	typ.	max.		
Output voltage V33-Version	V_Q	3.17	3.3	3.44	V	$5 \text{ mA} < I_Q < 400 \text{ mA}$ $4.7 \text{ V} < V_I < 40 \text{ V}$
Output voltage V25-Version	V_Q	2.4	2.5	2.6	–	$5 \text{ mA} < I_Q < 400 \text{ mA}$ $4.0 \text{ V} < V_Q < 40 \text{ V}$
Output current limitation ¹⁾	I_Q	400	600	–	mA	–
Current consumption; $I_q = I_I - I_Q$	I_q	–	100	220	μA	$I_Q = 1 \text{ mA}$
Current consumption; $I_q = I_I - I_Q$	I_q	–	8	15	mA	$I_Q = 250 \text{ mA}$
	I_q	–	20	30	mA	$I_Q = 400 \text{ mA}$
Drop voltage ¹⁾ V33-Version	V_{dr}	–	0.7	1.2	V	$I_Q = 300 \text{ mA}$ $V_{\text{dr}} = V_I - V_Q$
Drop voltage ¹⁾ V25-Version	V_{dr}	–	1.0	1.5	V	$I_Q = 300 \text{ mA}$ $V_{\text{dr}} = V_I - V_Q$
Load regulation	ΔV_Q	–	40	70	mV	$I_Q = 5 \text{ mA}$ to 300 mA
Line regulation	ΔV_Q	–	10	25	mV	$\Delta V_I = 12 \text{ V}$ to 32 V $I_Q = 5 \text{ mA}$
Power supply ripple rejection	$PSRR$	–	60	–	dB	$f_r = 100 \text{ Hz}$; $V_r = 0.5 V_{\text{SS}}$
Temperature output voltage drift	$\frac{dV_Q}{dT}$	–	0.5	–	mV/K	–

¹⁾ Measured when the output voltage V_Q has dropped 100 mV from the nominal value obtained at $V_I = 6 \text{ V}$.

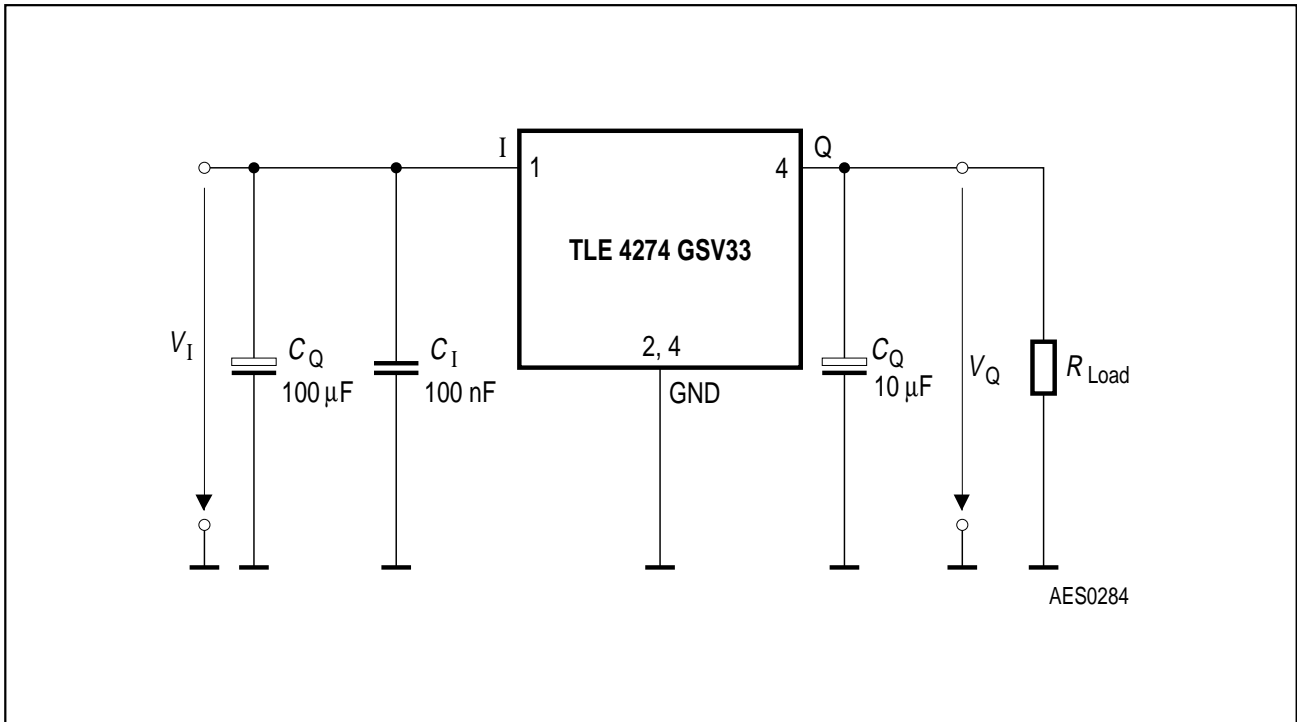

Figure 3
Measuring Circuit

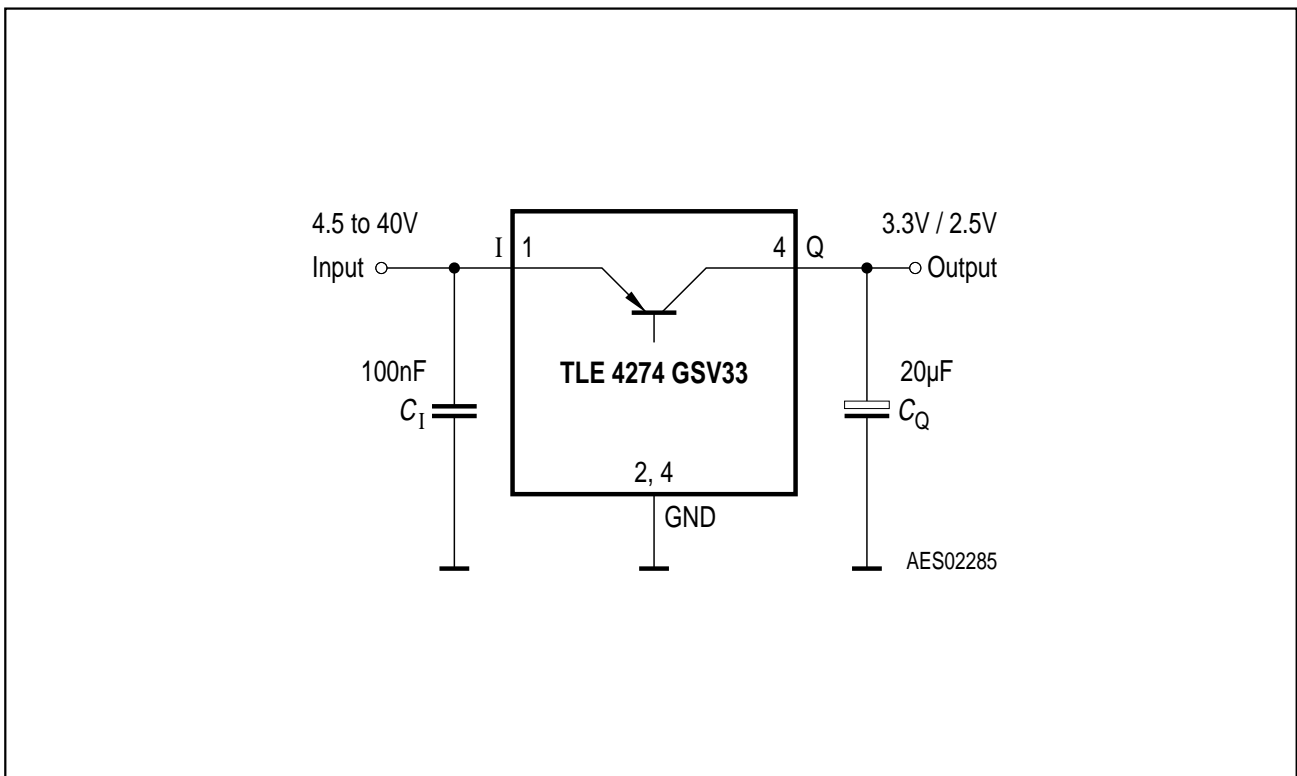

Figure 4
Application Circuit 1

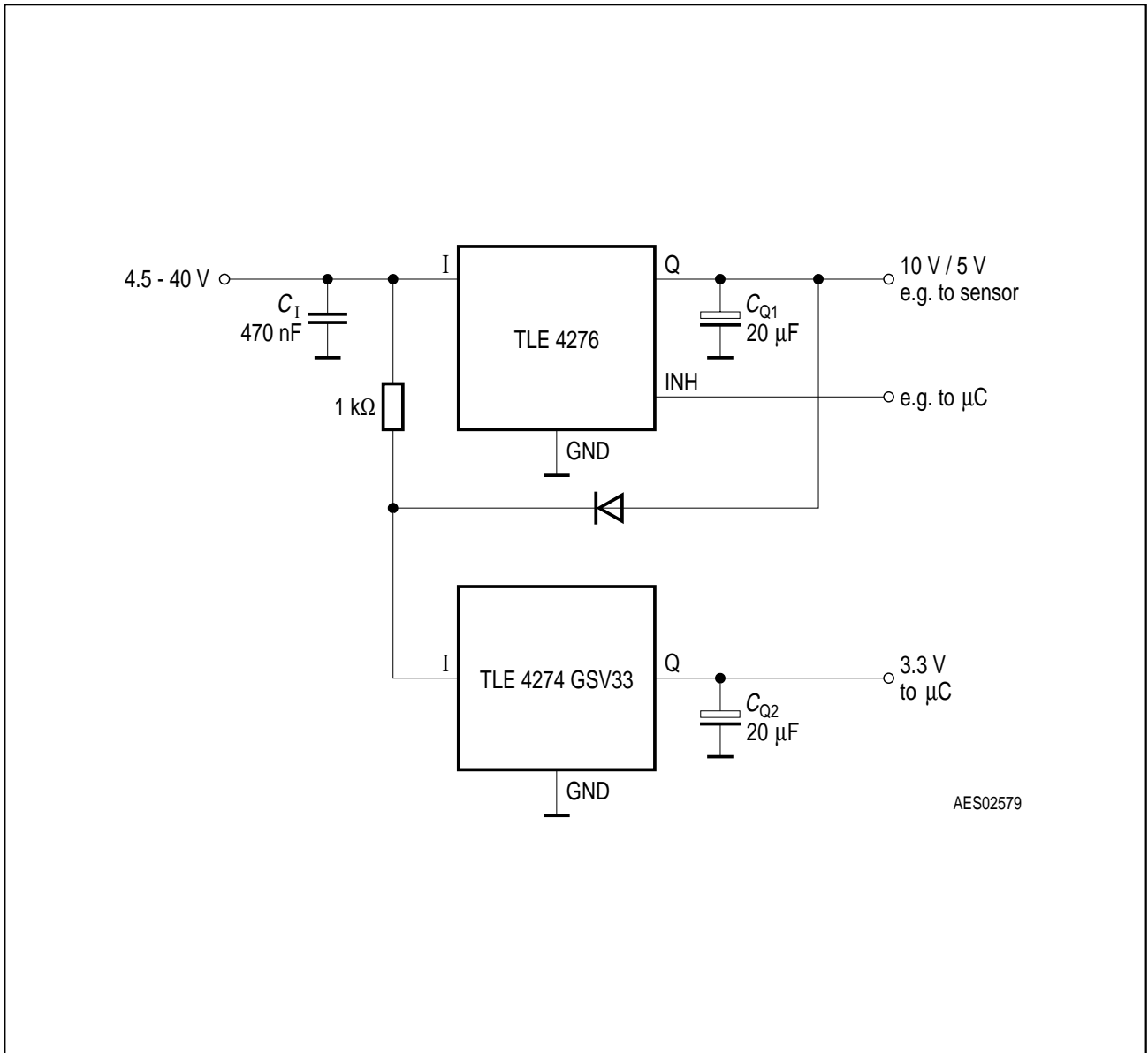
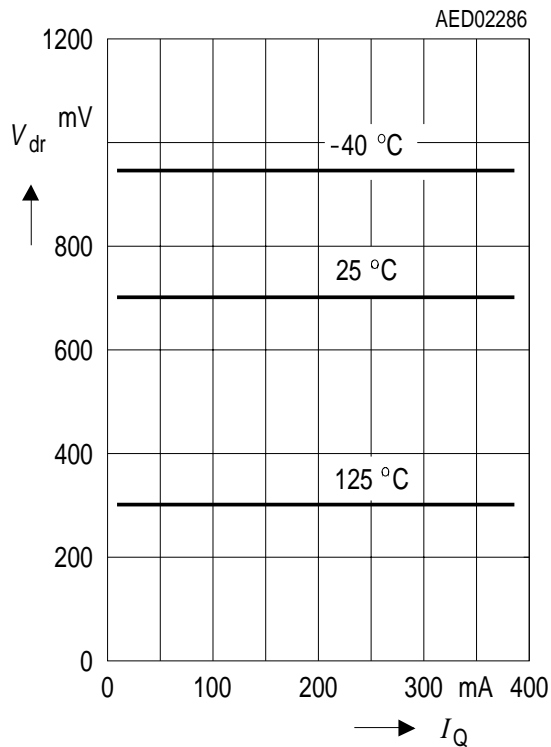

Figure 5
Application Circuit 2 (Voltage Dropper)

Typical Performance Characteristics:

Drop Voltage V_{dr} versus Output Current I_Q



Output Current I_Q versus Input Voltage V_I

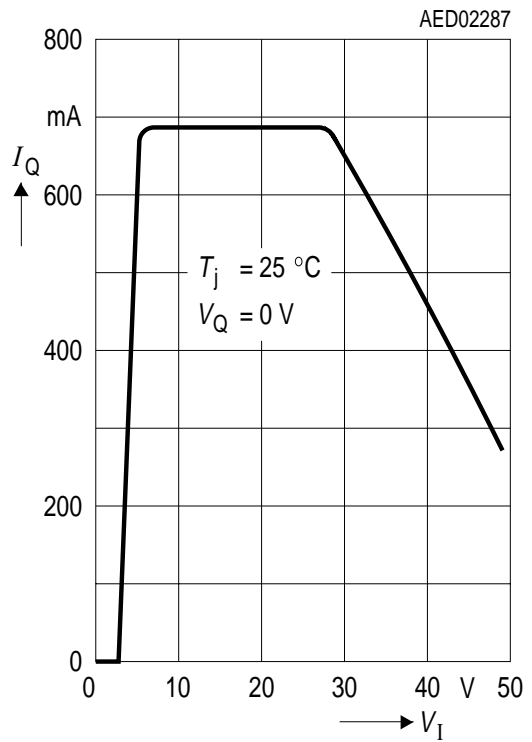

Current Consumption I_q versus Output Current I_Q (high load)

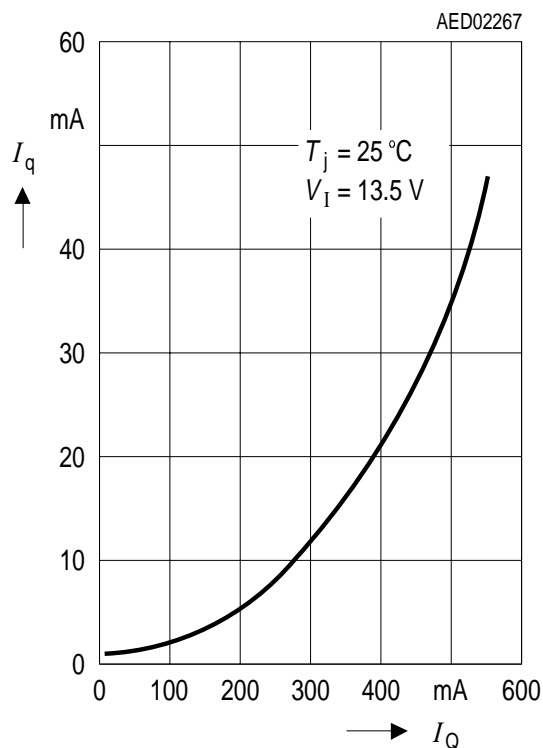

Current Consumption I_q versus Output Current I_Q (low load)

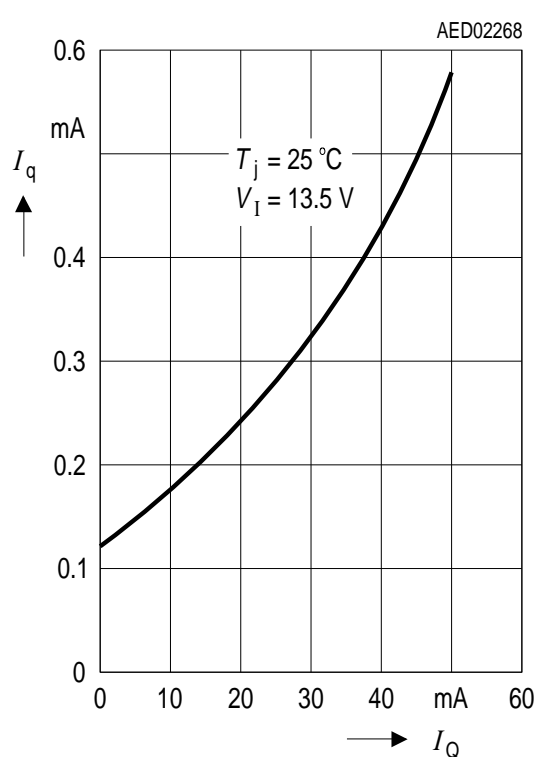

Typical Performance Characteristics:

Output Voltage V_Q versus Junction Temperature T_j (V33-Version)

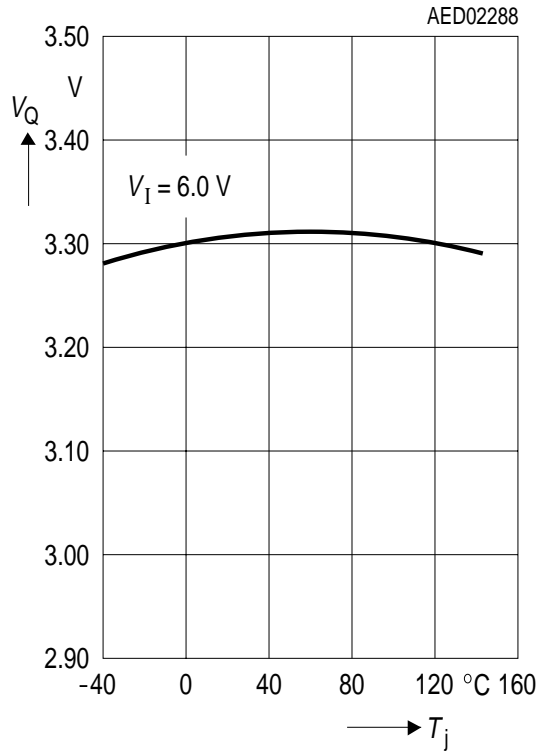

Input Current I_I versus Input Voltage V_I (V33-Version)

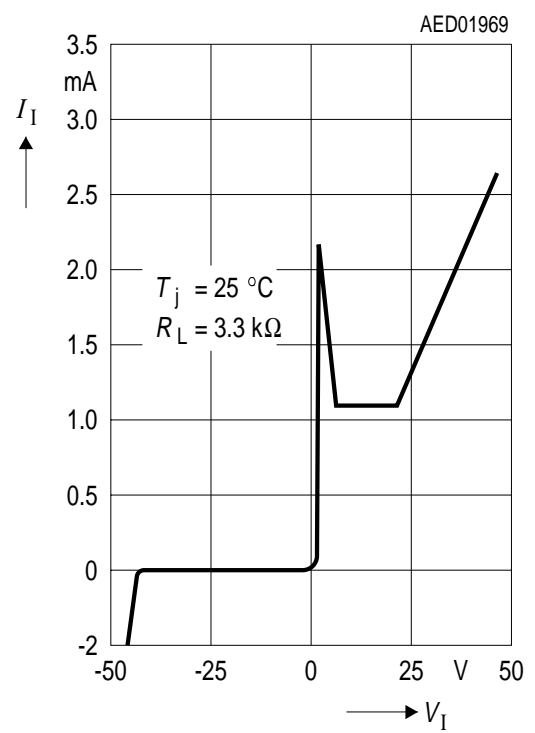

Package Outlines

P-SOT223-4-1 (SMD)
(Plastic Small Outline Transistor)

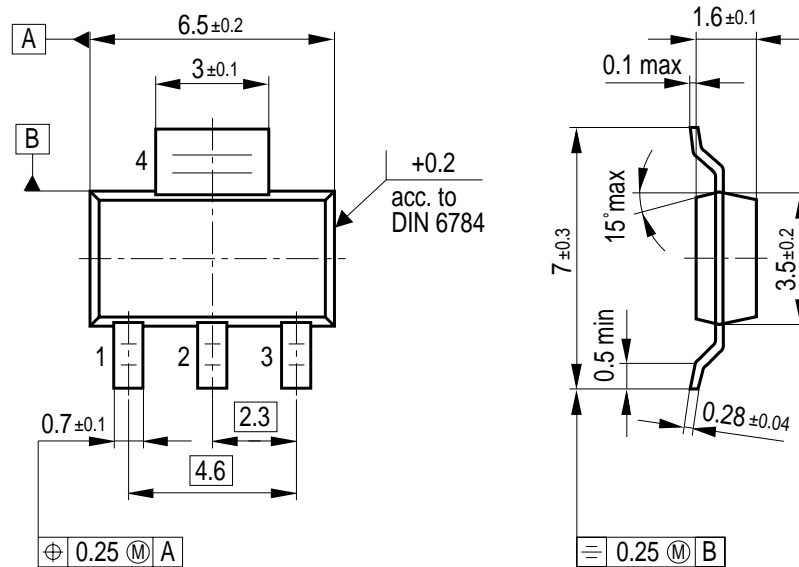

Sorts of Packing

Package outlines for tubes, trays etc. are contained in our Data Book "Package Information"

SMD = Surface Mounted Device

Dimensions in mm

P-TO252-3-1 (D-PAK)
 (Plastic Transistor Single Outline)

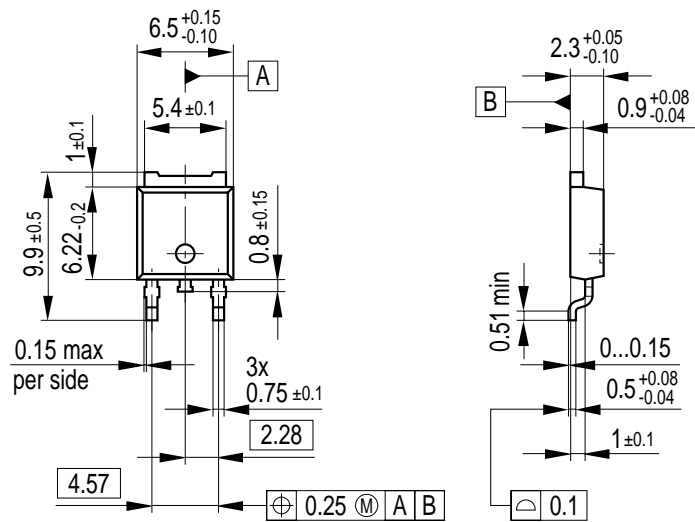

GPT09051

All metal surfaces tin plated, except area of cut.

Sorts of Packing

Package outlines for tubes, trays etc. are contained in our Data Book "Package Information"

SMD = Surface Mounted Device

Dimensions in mm