



BCD TO 7-SEGMENT DECODER

The SN54/74LS48 is a BCD to 7-Segment Decoder consisting of NAND gates, input buffers and seven AND-OR-INVERT gates. Seven NAND gates and one driver are connected in pairs to make BCD data and its complement available to the seven decoding AND-OR-INVERT gates. The remaining NAND gate and three input buffers provide lamp test, blanking input/ripple-blanking input for the LS48.

The circuit accepts 4-bit binary-coded-decimal (BCD) and, depending on the state of the auxiliary inputs, decodes this data to drive other components. The relative positive logic output levels, as well as conditions required at the auxiliary inputs, are shown in the truth tables.

The LS48 circuit incorporates automatic leading and/or trailing edge zero-blanking control (RBI and RBO). Lamp Test (LT) may be activated any time when the BI/RBO node is HIGH. Both devices contain an overriding blanking input (BI) which can be used to control the lamp intensity by varying the frequency and duty cycle of the BI input signal or to inhibit the outputs.

- Lamp Intensity Modulation Capability (BI/RBO)
- Internal Pull-Ups Eliminate Need for External Resistors
- Input Clamp Diodes Eliminate High-Speed Termination Effects

CONNECTION DIAGRAM DIP (TOP VIEW)

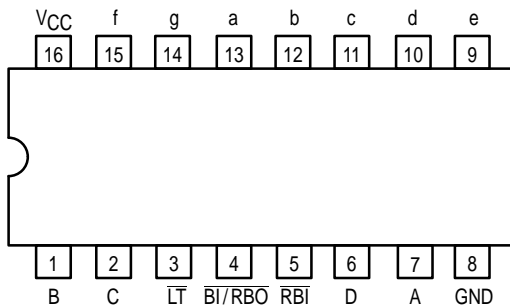

LOGIC DIAGRAM

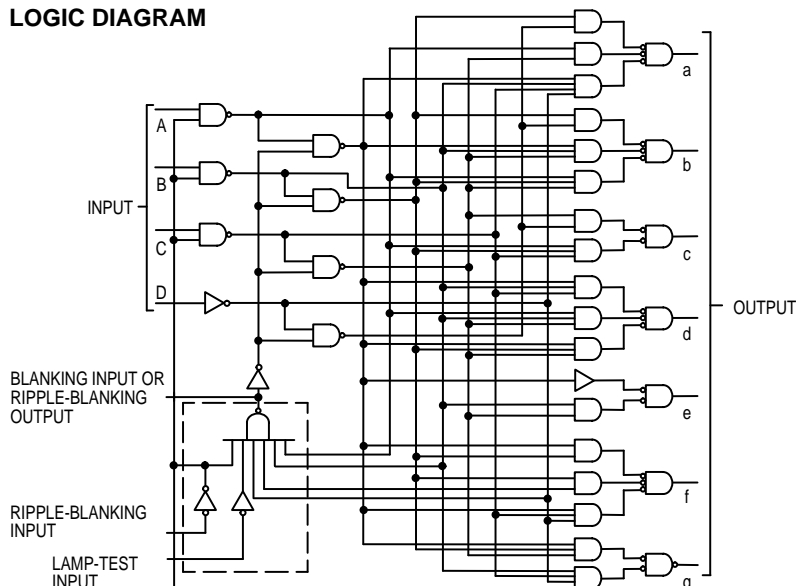

SN54/74LS48

BCD TO 7-SEGMENT DECODER

LOW POWER SCHOTTKY

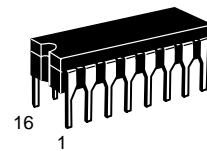

J SUFFIX
CERAMIC
CASE 620-09

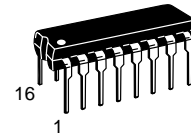

N SUFFIX
PLASTIC
CASE 648-08

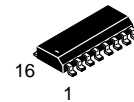

D SUFFIX
SOIC
CASE 751B-03

ORDERING INFORMATION

SN54LSXXJ	Ceramic
SN74LSXXN	Plastic
SN74LSXXD	SOIC

LOGIC SYMBOL

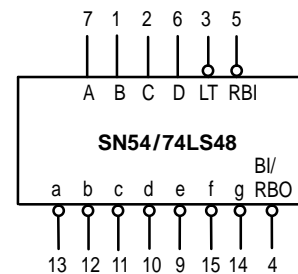

VCC = PIN 16
GND = PIN 8

SN54/74LS48

PIN NAMES

A, B, C, D	BCD Inputs
$\overline{\text{RBI}}$	Ripple-Blanking (Active Low) Input
$\overline{\text{LT}}$	Lamp-Test (Active Low) Input
$\overline{\text{BI/RBO}}$	Blanking Input or Ripple-Blanking Output (Active Low)
$\overline{\text{BI}}$	Blanking (Active Low) Input

LOADING (Note a)

	HIGH	LOW
	0.5 U.L.	0.25 U.L.
	0.5 U.L.	0.25 U.L.
	0.5 U.L.	0.25 U.L.
	0.5 U.L.	0.75 U.L.
	1.2 U.L.	2(1) U.L.
	0.5 U.L.	0.25 U.L.
Open-Collector		3.75 (1.25) U.L. (48)

NOTES:

- a) Unit Load (U.L.) = 40 μA HIGH/1.6 mA LOW
 b) Output current measured at $V_{\text{OUT}} = 0.5 \text{ V}$
 Output LOW drive factor is SN54LS/74LS48: 1.25 U.L. for Military (54), 3.75 U.L. for Commercial (74).

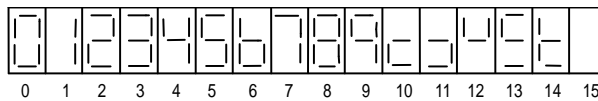

NUMERICAL DESIGNATIONS — RESULTANT DISPLAYS

TRUTH TABLE SN54/74LS48

DECIMAL OR FUNCTION	INPUTS						OUTPUTS							NOTE	
	$\overline{\text{LT}}$	$\overline{\text{RBI}}$	D	C	B	A	$\overline{\text{BI/RBO}}$	a	b	c	d	e	f		g
0	H	H	L	L	L	L	H	H	H	H	H	H	H	L	1
1	H	X	L	L	L	H	H	L	H	H	L	L	L	L	1
2	H	X	L	L	H	L	H	H	H	L	H	H	L	H	
3	H	X	L	L	H	H	H	H	H	H	L	L	L	H	
4	H	X	L	H	L	L	H	L	H	H	L	L	H	H	
5	H	X	L	H	L	H	H	H	L	H	H	L	H	H	
6	H	X	L	H	H	L	H	L	L	H	H	H	H	H	
7	H	X	L	H	H	H	H	H	H	H	L	L	L	L	
8	H	X	H	L	L	L	H	H	H	H	H	H	H	H	
9	H	X	H	L	L	H	H	H	H	H	L	L	H	H	
10	H	X	H	L	H	L	H	L	L	L	H	H	L	H	
11	H	X	H	L	H	H	H	L	L	H	H	L	L	H	
12	H	X	H	H	L	L	H	L	H	L	L	L	H	H	
13	H	X	H	H	L	H	H	H	L	L	L	H	L	H	
14	H	X	H	H	H	L	H	L	L	L	H	H	H	H	
15	H	X	H	H	H	H	H	L	L	L	L	L	L	L	
$\overline{\text{BI}}$	X	X	X	X	X	X	L	L	L	L	L	L	L	L	2
$\overline{\text{RBI}}$	H	L	L	L	L	L	L	L	L	L	L	L	L	L	3
$\overline{\text{LT}}$	L	X	X	X	X	X	H	H	H	H	H	H	H	H	4

NOTES:

- (1) $\overline{\text{BI/RBO}}$ is wired-AND logic serving as blanking input ($\overline{\text{BI}}$) and/or ripple-blanking output ($\overline{\text{RBO}}$). The blanking out ($\overline{\text{BI}}$) must be open or held at a HIGH level when output functions 0 through 15 are desired, and ripple-blanking input ($\overline{\text{RBI}}$) must be open or at a HIGH level if blanking of a decimal 0 is not desired. X=input may be HIGH or LOW.
- (2) When a LOW level is applied to the blanking input (forced condition) all segment outputs go to a LOW level, regardless of the state of any other input condition.
- (3) When ripple-blanking input ($\overline{\text{RBI}}$) and inputs A, B, C, and D are at LOW level, with the lamp test input at HIGH level, all segment outputs go to a HIGH level and the ripple-blanking output ($\overline{\text{RBO}}$) goes to a LOW level (response condition).
- (4) When the blanking input/ripple-blanking output ($\overline{\text{BI/RBO}}$) is open or held at a HIGH level, and a LOW level is applied to lamp-test input, all segment outputs go to a LOW level.

SN54/74LS48

GUARANTEED OPERATING RANGES

Symbol	Parameter		Min	Typ	Max	Unit
V _{CC}	Supply Voltage	54 74	4.5 4.75	5.0 5.0	5.5 5.25	V
T _A	Operating Ambient Temperature Range	54 74	-55 0	25 25	125 70	°C
I _{OH}	Output Current — High \bar{a} to \bar{g}	54, 74			-100	μA
I _{OH}	Output Current — High $\overline{BI/RBO}$	54, 74			-50	μA
I _{OL}	Output Current — Low \bar{a} to \bar{g}	54 74			2.0 6.0	mA
I _{OL}	Output Current — Low $\overline{BI/RBO}$	54 74			1.6 3.2	mA

DC CHARACTERISTICS OVER OPERATING TEMPERATURE RANGE (unless otherwise specified)

Symbol	Parameter	Limits			Unit	Test Conditions
		Min	Typ	Max		
V _{IH}	Input HIGH Voltage	2.0			V	Guaranteed Input HIGH Voltage for All Inputs
V _{IL}	Input LOW Voltage	54		0.7	V	Guaranteed Input LOW Voltage for All Inputs
		74		0.8		
V _{IK}	Input Clamp Diode Voltage			-1.5	V	V _{CC} = MIN, I _{IN} = -18 mA
V _{OH}	Output HIGH Voltage	2.4	4.2		μA	V _{CC} = MIN, I _{OH} = -50 μA, V _{IN} = V _{IH} or U.L. per Truth Table
I _O	Output Current \bar{a} to \bar{g}	-1.3	-2.0		mA	V _{CC} = MIN, V _O = 0.85 V Input Conditioner as for V _{OH}
V _{OL}	Output LOW Voltage \bar{a} to \bar{g}	54, 74		0.4	V	I _{OL} = 2.0 mA V _{CC} = MIN, V _{IH} = 2.0 V V _{IL} = V _{IL} MAX
		74		0.5	V	
V _{OL}	Output LOW Voltage $\overline{BI/RBO}$	54, 74		0.4	V	I _{OL} = 1.6 mA V _{CC} = MAX, V _{IH} = 2.0 V V _{IL} = V _{IL} MAX
		74		0.5	V	
I _{IH}	Input HIGH Current (Except $\overline{BI/RBO}$)			20	μA	V _{CC} = MAX, V _{IN} = 2.7 V
				0.1	mA	V _{CC} = MAX, V _{IN} = 7.0 V
I _{IL}	Input LOW Current (Except $\overline{BI/RBO}$)			-0.4	mA	V _{CC} = MAX, V _{IN} = 0.4 V
I _{IL}	Input LOW Current $\overline{BI/RBO}$			-1.2	mA	V _{CC} = MAX, V _{IN} = 0.4 V
I _{CC}	Power Supply Current		25	38	mA	V _{CC} = MAX
I _{OS}	Short Circuit Current $\overline{BI/RBO}$ (Note 1)	-0.3		-2.0	mA	V _{CC} = MAX

Note 1: Not more than one output should be shorted at a time, nor for more than 1 second.

AC CHARACTERISTICS (V_{CC} = 5.0 V, T_A = 25°C)

Symbol	Parameter	Limits			Unit	Test Conditions
		Min	Typ	Max		
t _{PHL}	Propagation Delay Time, HIGH-to-LOW Level Output from A Input			100	ns	C _L = 15 pF, R _L = 4.0 kΩ
t _{PLH}	Propagation Delay Time, LOW-to-HIGH Level Output from A Input			100	ns	
t _{PHL}	Propagation Delay Time, HIGH-to-LOW Level Output from \overline{RBI} Input			100	ns	C _L = 15 pF, R _L = 6.0 kΩ
t _{PLH}	Propagation Delay Time, LOW-to-HIGH Level Output from \overline{RBI} Input			100	ns	