



# High-Linearity, 1700MHz to 2200MHz Upconversion/ Downconversion Mixer with LO Buffer/Switch

MAX2039

## General Description

The MAX2039 high-linearity passive upconverter or downconverter mixer is designed to provide 7.3dB NF and a 7.1dB conversion loss for an RF frequency range of 1700MHz to 2200MHz to support UMTS/WCDMA, DCS, and PCS base-station transmitter or receiver applications. The IIP3 is typically +34.5dBm and +33.5dBm for downconversion and upconversion operation, respectively. With an LO frequency range of 1500MHz to 2000MHz, this particular mixer is ideal for low-side LO injection architectures. (For a pin-to-pin-compatible mixer meant for high-side LO injection, contact the factory.)

In addition to offering excellent linearity and noise performance, the MAX2039 also yields a high level of component integration. This device includes a double-balanced passive mixer core, a dual-input LO selectable switch, and an LO buffer. On-chip baluns are also integrated to allow for a single-ended RF input for downconversion (or RF output for upconversion), and single-ended LO inputs. The MAX2039 requires a nominal LO drive of 0dBm, and supply current is guaranteed to be below 135mA.

The MAX2039 is pin compatible with the MAX2031 815MHz to 995MHz mixer, making this family of passive upconverters and downconverters ideal for applications where a common PC board layout is used for both frequency bands.

The MAX2039 is available in a compact 20-pin thin QFN package (5mm x 5mm) with an exposed paddle. Electrical performance is guaranteed over the extended -40°C to +85°C temperature range.

## Applications

- UMTS/WCDMA Base Stations
- DCS1800/PCS1900 EDGE Base Stations
- cdmaOne™ and cdma2000® Base Stations
- PHS/PAS Base Stations
- Predistortion Receivers
- Fixed Broadband Wireless Access
- Wireless Local Loop
- Private Mobile Radio
- Military Systems
- Microwave Links
- Digital and Spread-Spectrum Communication Systems

cdmaOne is a trademark of CDMA Development Group.

cdma2000 is a registered trademark of Telecommunications Industry Association.



## Features

- ◆ 1700MHz to 2200MHz RF Frequency Range
- ◆ 1500MHz to 2000MHz LO Frequency Range
- ◆ 1900MHz to 2400MHz LO Frequency Range (Contact Factory)
- ◆ DC to 350MHz IF Frequency Range
- ◆ 7.1dB Conversion Loss
- ◆ +34.5dBm Input IP3 (Downconversion)
- ◆ +24.4dBm Input 1dB Compression Point
- ◆ 7.3dB Noise Figure
- ◆ Integrated LO Buffer
- ◆ Integrated RF and LO Baluns
- ◆ Low -3dBm to +3dBm LO Drive
- ◆ Built-In SPDT LO Switch with 45dB LO1 to LO2 Isolation and 50ns Switching Time
- ◆ Pin Compatible with the MAX2031 815MHz to 995MHz Mixer
- ◆ External Current-Setting Resistor Provides Option for Operating Mixer in Reduced-Power/Reduced-Performance Mode
- ◆ Lead-Free Package Available

## Ordering Information

PART	TEMP RANGE	PIN-PACKAGE	PKG CODE
MAX2039ETP	-40°C to +85°C	20 Thin QFN-EP* (5mm x 5mm) bulk	T2055-3
MAX2039ETP-T	-40°C to +85°C	20 Thin QFN-EP* (5mm x 5mm) T/R	T2055-3
MAX2039ETP+D	-40°C to +85°C	20 Thin QFN-EP* (5mm x 5mm) lead-free bulk	T2055-3
MAX2039ETP+TD	-40°C to +85°C	20 Thin QFN-EP* (5mm x 5mm) lead-free T/R	T2055-3

\* EP = Exposed paddle.

+ = Lead free.

D = Dry pack.

Pin Configuration and Typical Application Circuit appear at end of data sheet.

Maxim Integrated Products 1

**For pricing, delivery, and ordering information, please contact Maxim/Dallas Direct! at 1-888-629-4642, or visit Maxim's website at [www.maxim-ic.com](http://www.maxim-ic.com).**

# High-Linearity, 1700MHz to 2200MHz Upconversion/ Downconversion Mixer with LO Buffer/Switch

## ABSOLUTE MAXIMUM RATINGS

V <sub>CC</sub> to GND .....	-0.3V to +5.5V
TAP, LOBIAS, LOSEL to GND .....	-0.3V to (V <sub>CC</sub> + 0.3V)
LO1, LO2, IF+, IF- to GND .....	-0.3V to +0.3V
RF, IF, LO1, LO2 Input Power .....	+15dBm
RF (RF is DC shorted to GND through a balun) .....	50mA
Continuous Power Dissipation 20-Pin QFN-EP (derate 20mW/°C above T <sub>A</sub> = +70°C) .....	2.2W

θ <sub>JA</sub> .....	+33°C/W
θ <sub>JC</sub> .....	+8°C/W
Operating Temperature Range (Note A) .... T <sub>C</sub> =	-40°C to +85°C
Junction Temperature .....	+150°C
Storage Temperature Range .....	-65°C to +165°C
Lead Temperature (soldering, 10s) .....	+300°C

**Note A:** T<sub>C</sub> is the temperature on the exposed paddle of the package.

Stresses beyond those listed under "Absolute Maximum Ratings" may cause permanent damage to the device. These are stress ratings only, and functional operation of the device at these or any other conditions beyond those indicated in the operational sections of the specifications is not implied. Exposure to absolute maximum rating conditions for extended periods may affect device reliability.

## DC ELECTRICAL CHARACTERISTICS

(MAX2039 Typical Application Circuit, V<sub>CC</sub> = +4.75V to +5.25V, T<sub>C</sub> = -40°C to +85°C, no RF signals applied, IF+ and IF- DC grounded through a transformer. Typical values are at V<sub>CC</sub> = +5V, T<sub>C</sub> = +25°C, unless otherwise noted.)

PARAMETER	SYMBOL	CONDITIONS	MIN	TYP	MAX	UNITS
Supply Voltage	V <sub>CC</sub>		4.75	5.00	5.25	V
Supply Current	I <sub>CC</sub>			104	135	mA
LO_SEL Input Logic Low	V <sub>IL</sub>				0.8	V
LO_SEL Input Logic High	V <sub>IH</sub>		2			V

## AC ELECTRICAL CHARACTERISTICS (DOWNCONVERTER OPERATION)

(MAX2039 Typical Application Circuit, V<sub>CC</sub> = +4.75V to +5.25V, T<sub>C</sub> = -40°C to +85°C, RF and LO ports are driven from 50Ω sources, P<sub>LO</sub> = -3dBm to +3dBm, P<sub>RF</sub> = 0dBm, f<sub>RF</sub> = 1700MHz to 2200MHz, f<sub>LO</sub> = 1500MHz to 2000MHz, f<sub>IF</sub> = 200MHz, f<sub>RF</sub> > f<sub>LO</sub>, unless otherwise noted. Typical values are at V<sub>CC</sub> = +5V, P<sub>RF</sub> = 0dBm, P<sub>LO</sub> = 0dBm, f<sub>RF</sub> = 1900MHz, f<sub>LO</sub> = 1700MHz, f<sub>IF</sub> = 200MHz, T<sub>C</sub> = +25°C, unless otherwise noted.) (Notes 1, 2)

PARAMETER	SYMBOL	CONDITIONS	MIN	TYP	MAX	UNITS
RF Frequency Range	f <sub>RF</sub>	(Note 3)	1700		2200	MHz
LO Frequency Range	f <sub>LO</sub>	(Note 3)	1500		2000	MHz
		(Contact factory)	1900		2400	
IF Frequency Range	f <sub>IF</sub>	External IF transformer dependent	DC		350	MHz
Conversion Loss	L <sub>C</sub>	P <sub>RF</sub> < +2dBm		7.1		dB
Loss Variation Over Temperature		T <sub>C</sub> = -40°C to +85°C		0.0075		dB/°C
Input Compression Point	P <sub>1dB</sub>	(Note 4)		24.4		dBm
Input Third-Order Intercept Point	IIP3	Two tones: f <sub>RF1</sub> = 2000MHz, f <sub>RF2</sub> = 2001MHz, P <sub>RF</sub> = +5dBm/tone, f <sub>LO</sub> = 1800MHz, P <sub>LO</sub> = 0dBm	31	34.5		dBm
Input IP3 Variation Over Temperature		T <sub>C</sub> = -40°C to +85°C		±0.75		dB
Noise Figure	NF	Single sideband		7.3		dB

# High-Linearity, 1700MHz to 2200MHz Upconversion/ Downconversion Mixer with LO Buffer/Switch

MAX2039

## AC ELECTRICAL CHARACTERISTICS (DOWNCONVERTER OPERATION) (continued)

(MAX2039 Typical Application Circuit,  $V_{CC} = +4.75V$  to  $+5.25V$ ,  $T_C = -40^{\circ}C$  to  $+85^{\circ}C$ , RF and LO ports are driven from  $50\Omega$  sources,  $P_{LO} = -3dBm$  to  $+3dBm$ ,  $P_{RF} = 0dBm$ ,  $f_{RF} = 1700MHz$  to  $2200MHz$ ,  $f_{LO} = 1500MHz$  to  $2000MHz$ ,  $f_{IF} = 200MHz$ ,  $f_{RF} > f_{LO}$ , unless otherwise noted. Typical values are at  $V_{CC} = +5V$ ,  $P_{RF} = 0dBm$ ,  $P_{LO} = 0dBm$ ,  $f_{RF} = 1900MHz$ ,  $f_{LO} = 1700MHz$ ,  $f_{IF} = 200MHz$ ,  $T_C = +25^{\circ}C$ , unless otherwise noted.) (Notes 1, 2)

PARAMETER	SYMBOL	CONDITIONS	MIN	TYP	MAX	UNITS
Noise Figure Under-Blocking		$P_{RF} = 5dBm$ , $f_{RF} = 2000MHz$ , $f_{LO} = 1810MHz$ , $f_{block} = 2100MHz$ (Note 5)		19		dB
LO Drive			-3		+3	dBm
Spurious Response at IF	2 x 2	$2RF - 2LO$ , $P_{RF} = 0dBm$		73		dBc
	3 x 3	$3RF - 3LO$ , $P_{RF} = 0dBm$		72		
LO1 to LO2 Isolation (Note 1)		LO2 selected, $1500MHz < f_{LO} < 1700MHz$	40	52		dB
		LO1 selected, $1500MHz < f_{LO} < 1700MHz$	40	45		
Maximum LO Leakage at RF Port		$P_{LO} = +3dBm$		-18		dBm
Maximum LO Leakage at IF Port		$P_{LO} = +3dBm$		-27.5		dBm
Minimum RF-to-IF Isolation				35		dB
LO Switching Time		50% of LOSEL to IF settled to within $2^{\circ}$		50		ns
RF Port Return Loss				18		dB
LO Port Return Loss		LO port selected, LO and IF terminated		16		dB
		LO port unselected, LO and IF terminated		26		
IF Port Return Loss		LO driven at $0dBm$ , RF terminated into $50\Omega$		20		dB

# High-Linearity, 1700MHz to 2200MHz Upconversion/ Downconversion Mixer with LO Buffer/Switch

## AC ELECTRICAL CHARACTERISTICS (UPCONVERTER OPERATION)

(MAX2039 *Typical Application Circuit*,  $V_{CC} = +4.75V$  to  $+5.25V$ ,  $T_C = -40^{\circ}C$  to  $+85^{\circ}C$ ,  $P_{LO} = -3dBm$  to  $+3dBm$ ,  $P_{IF} = 0dBm$ ,  $f_{RF} = 1700MHz$  to  $2200MHz$ ,  $f_{LO} = 1500MHz$  to  $2000MHz$ ,  $f_{IF} = 200MHz$ ,  $f_{RF} = f_{LO} + f_{IF}$ , unless otherwise noted. Typical values are at  $V_{CC} = +5V$ ,  $P_{IF} = 0dBm$ ,  $P_{LO} = 0dBm$ ,  $f_{RF} = 1900MHz$ ,  $f_{LO} = 1700MHz$ ,  $f_{IF} = 200MHz$ ,  $T_C = +25^{\circ}C$ , unless otherwise noted.) (Note 2)

PARAMETER	SYMBOL	CONDITIONS	MIN	TYP	MAX	UNITS
Input Compression Point	$P_{1dB}$	(Note 4)		24.4		dBm
Input Third-Order Intercept Point	IIP3	Two tones: $f_{IF1} = 200MHz$ , $f_{IF2} = 210MHz$ , $P_{IF} = +5dBm/$ tone, $f_{LO} = 1940MHz$ , $P_{LO} = 0dBm$	29.5	33.5		dBm
LO $\pm 2IF$ Spur		LO - 2IF		67		dBc
		LO + 2IF		63		
LO $\pm 3IF$ Spur		LO - 3IF		72		dBc
		LO + 3IF		76		
Output Noise Floor		$P_{OUT} = 0dBm$		-160		dBm/ Hz

**Note 1:** Guaranteed by design and characterization.

**Note 2:** All limits include external component losses. Output measurements taken at IF port for downconverter and RF port for upconverter from the *Typical Application Circuit*.

**Note 3:** Operation outside this range is possible, but with degraded performance of some parameters.

**Note 4:** Compression point characterized. It is advisable not to continuously operate the mixer RF or IF input above +15dBm.

**Note 5:** Measured with external LO source noise filtered such that the noise floor is -174dBm/Hz. This specification reflects the effects of all SNR degradations in the mixer, including the LO noise as defined in Maxim Application Note 2021.

# High-Linearity, 1700MHz to 2200MHz Upconversion/Downconversion Mixer with LO Buffer/Switch

## Typical Operating Characteristics

(MAX2039 Typical Application Circuit,  $V_{CC} = +5.0V$ ,  $P_{LO} = 0dBm$ ,  $P_{RF} = 0dBm$ ,  $f_{RF} > f_{LO}$ ,  $f_{IF} = 200MHz$ ,  $R_1 = 549\Omega$ , unless otherwise noted.)

### Downconverter Curves

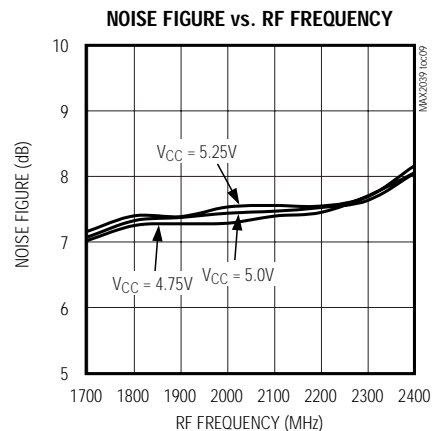
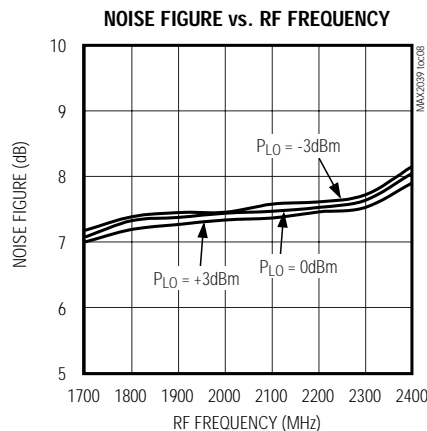
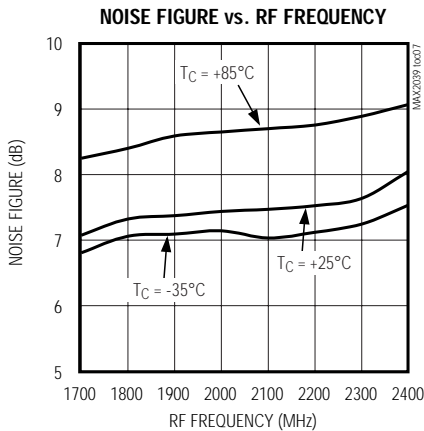
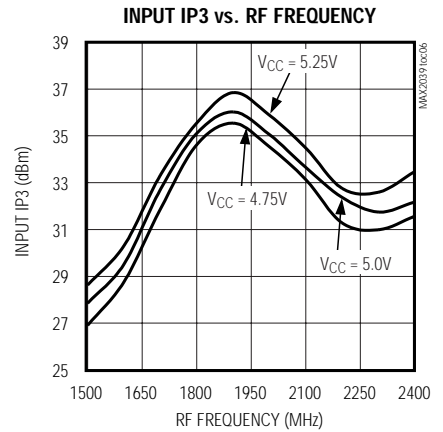
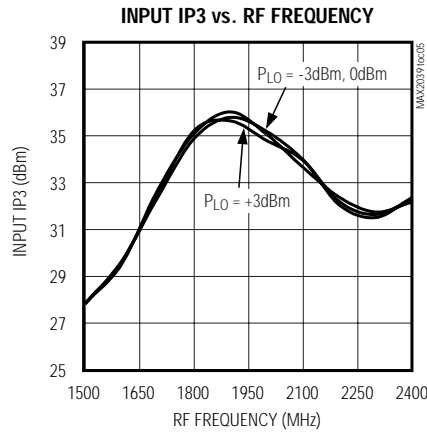
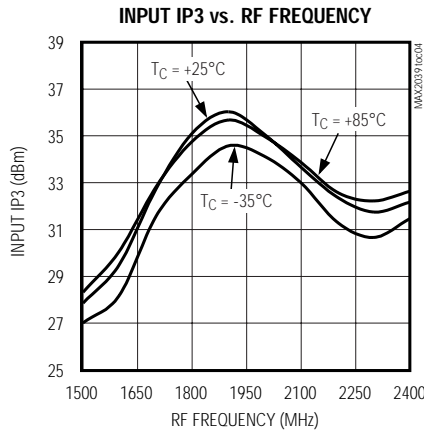
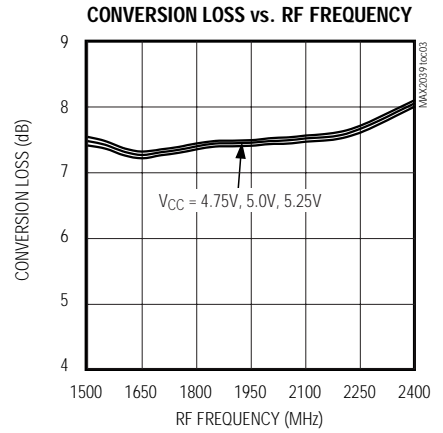
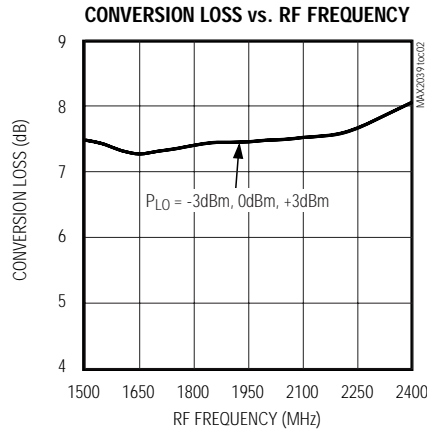
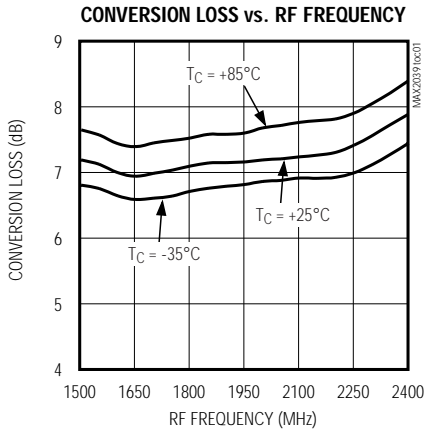

# High-Linearity, 1700MHz to 2200MHz Upconversion/Downconversion Mixer with LO Buffer/Switch

## Typical Operating Characteristics (continued)

(MAX2039 Typical Application Circuit,  $V_{CC} = +5.0V$ ,  $P_{LO} = 0dBm$ ,  $P_{RF} = 0dBm$ ,  $f_{RF} > f_{LO}$ ,  $f_{IF} = 200MHz$ ,  $R_1 = 549\Omega$ , unless otherwise noted.)

### Downconverter Curves

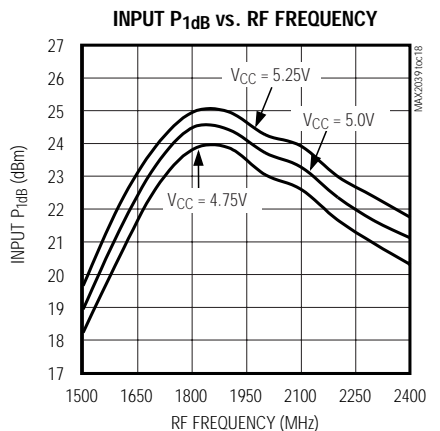
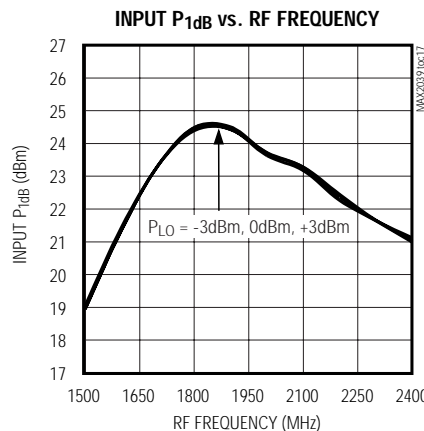
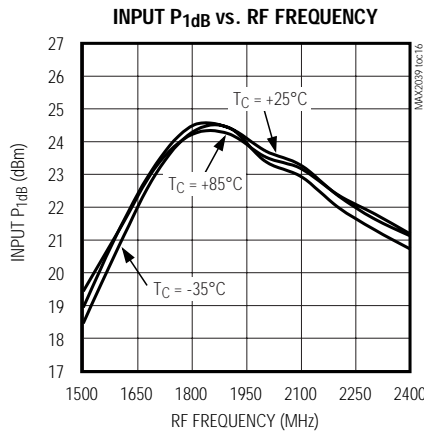
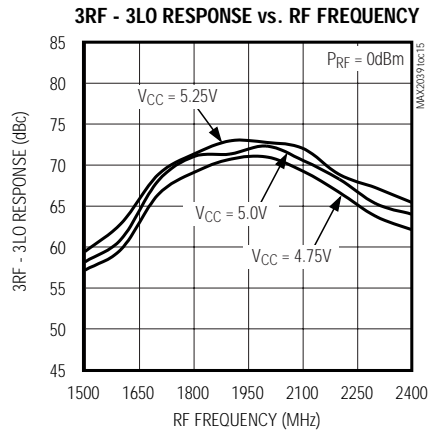
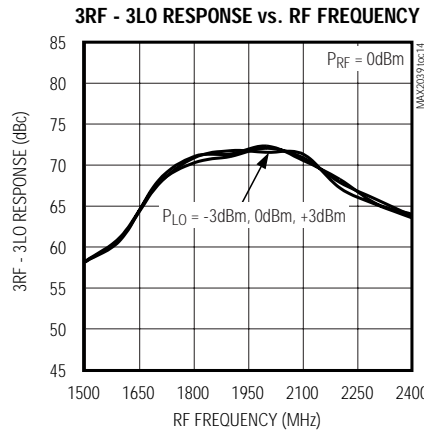
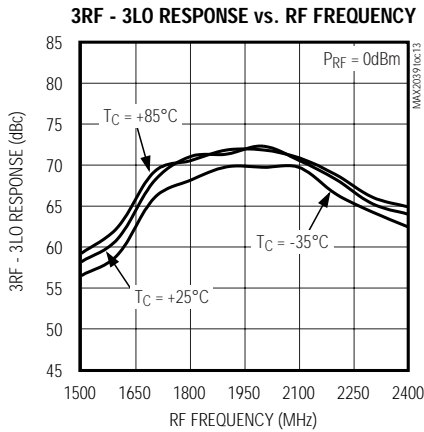
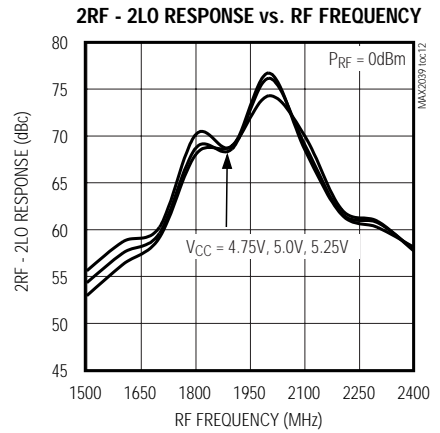
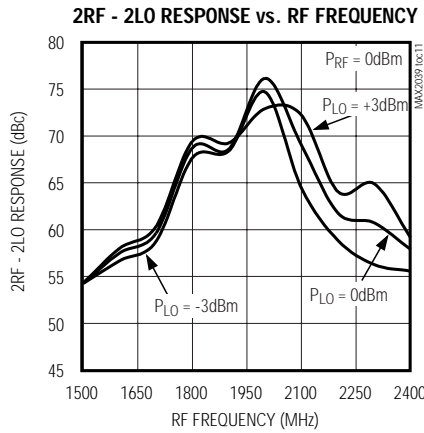
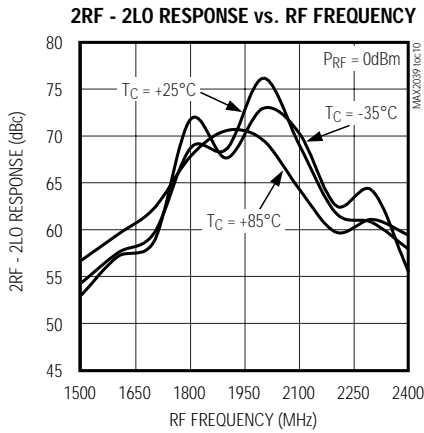

# High-Linearity, 1700MHz to 2200MHz Upconversion/Downconversion Mixer with LO Buffer/Switch

MAX2039

## Typical Operating Characteristics (continued)

(MAX2039 Typical Application Circuit,  $V_{CC} = +5.0V$ ,  $P_{LO} = 0dBm$ ,  $P_{RF} = 0dBm$ ,  $f_{RF} > f_{LO}$ ,  $f_{IF} = 200MHz$ ,  $R_1 = 549\Omega$ , unless otherwise noted.)

### Downconverter Curves

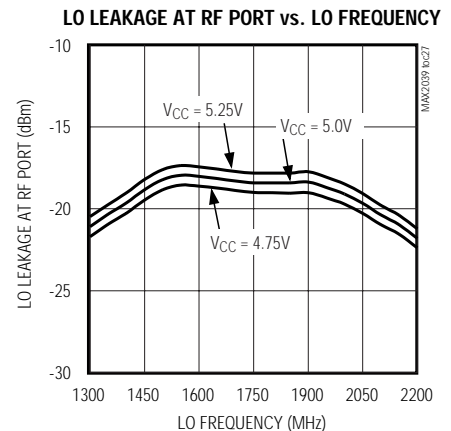
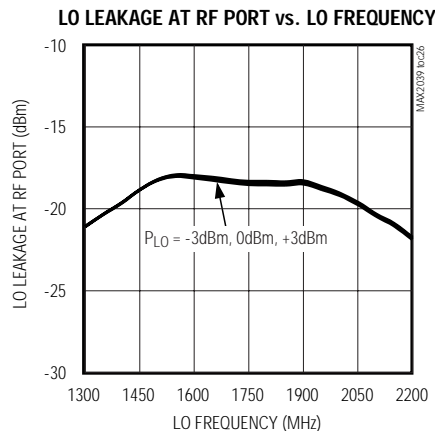
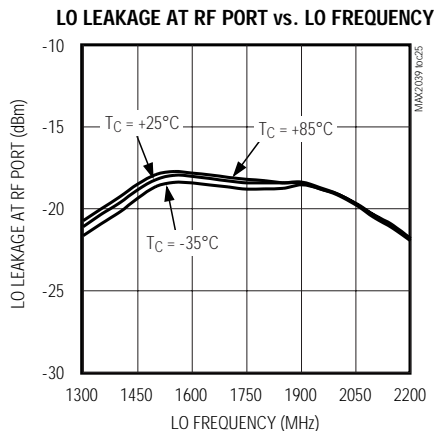
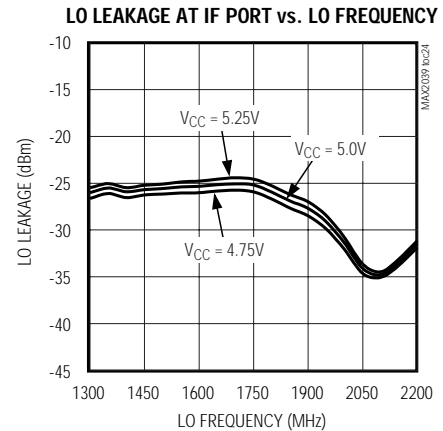
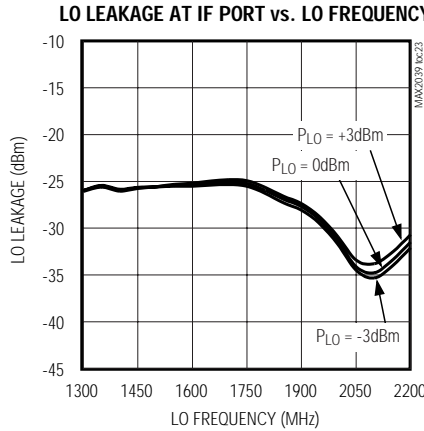
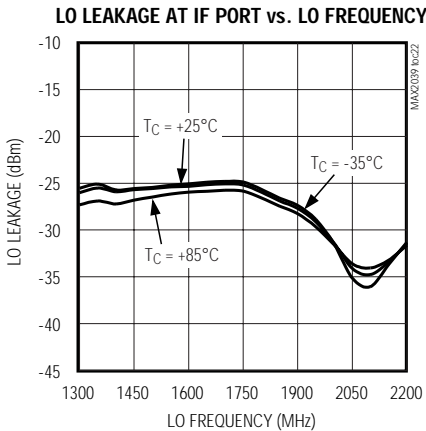
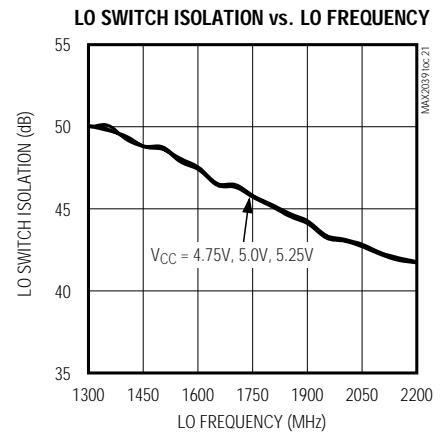
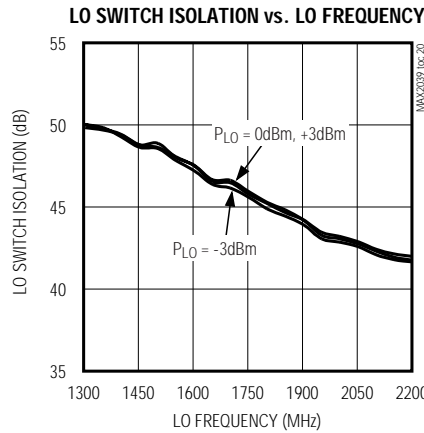
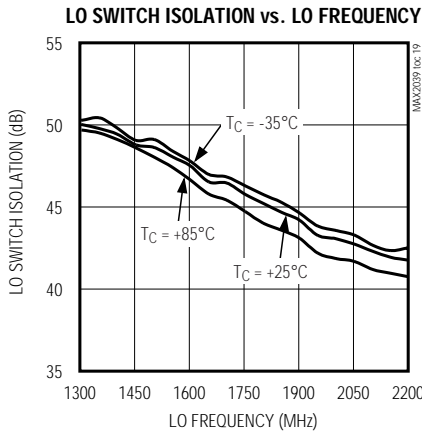

# High-Linearity, 1700MHz to 2200MHz Upconversion/Downconversion Mixer with LO Buffer/Switch

## Typical Operating Characteristics (continued)

(MAX2039 Typical Application Circuit,  $V_{CC} = +5.0V$ ,  $P_{LO} = 0dBm$ ,  $P_{RF} = 0dBm$ ,  $f_{RF} > f_{LO}$ ,  $f_{IF} = 200MHz$ ,  $R_1 = 549\Omega$ , unless otherwise noted.)

### Downconverter Curves

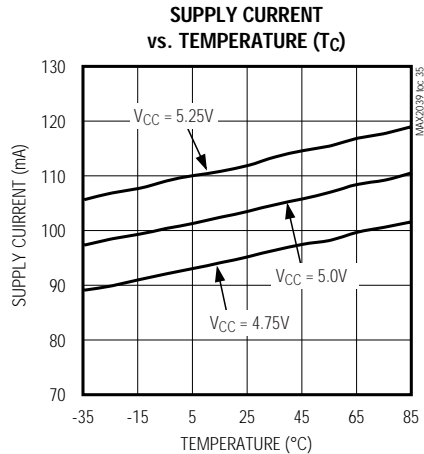
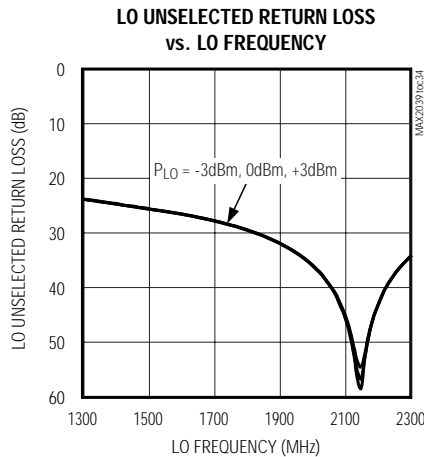
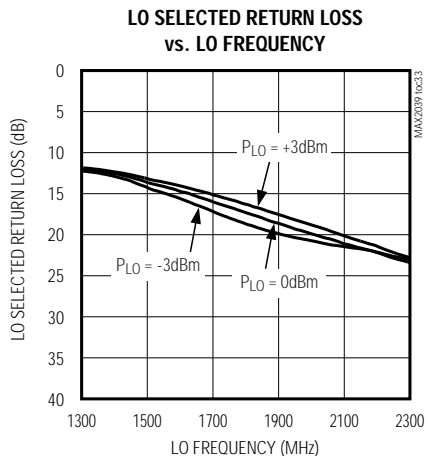
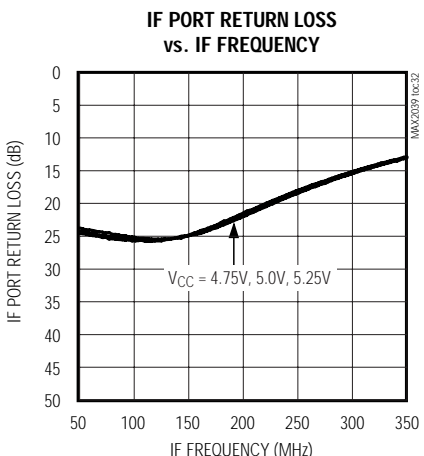
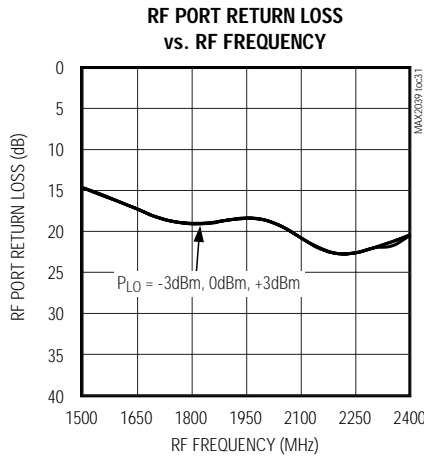
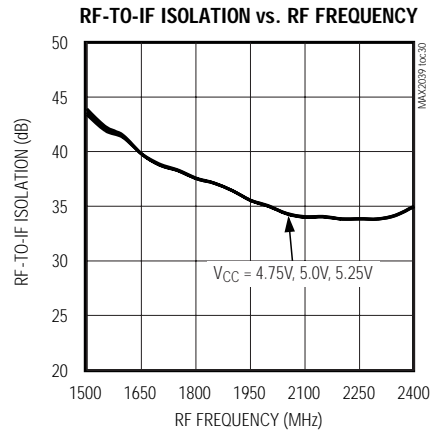
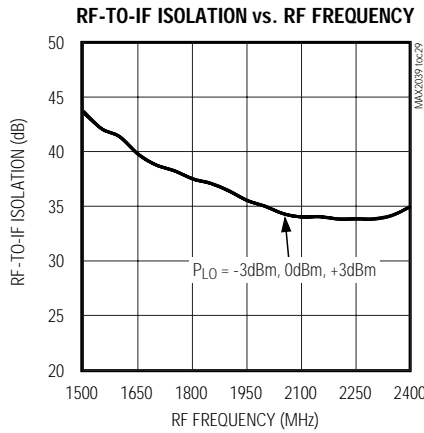
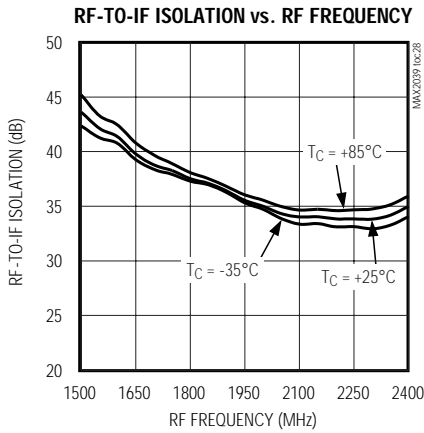



# High-Linearity, 1700MHz to 2200MHz Upconversion/Downconversion Mixer with LO Buffer/Switch

MAX2039

## Typical Operating Characteristics

(MAX2039 Typical Application Circuit,  $V_{CC} = +5.0V$ ,  $P_{LO} = 0dBm$ ,  $P_{IF} = 0dBm$ ,  $f_{RF} = f_{LO} + f_{IF}$ ,  $f_{IF} = 200MHz$ ,  $R_1 = 549\Omega$ , unless otherwise noted.)

### Upconverter Curves

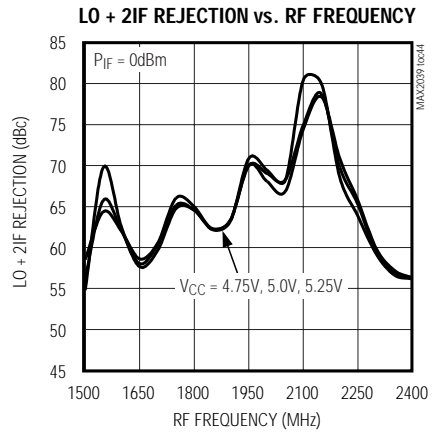
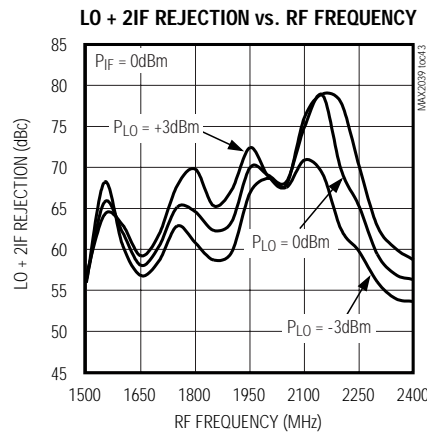
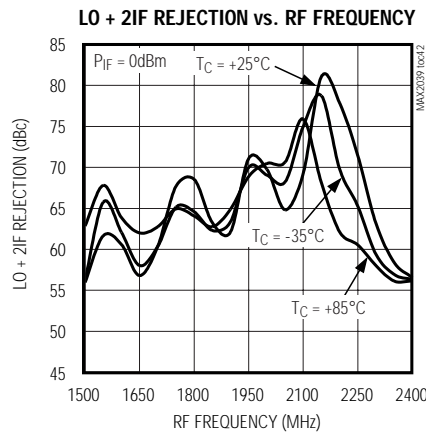
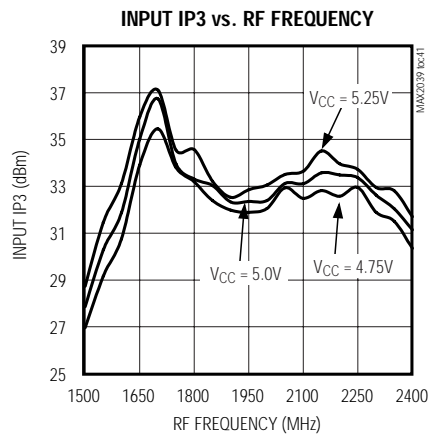
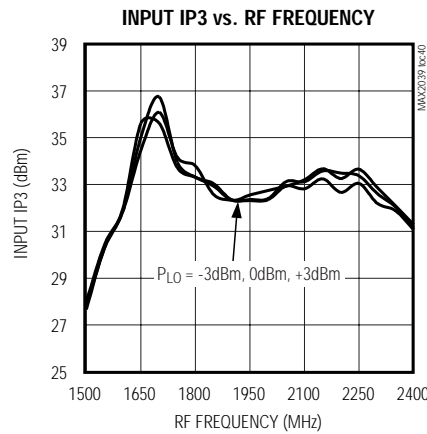
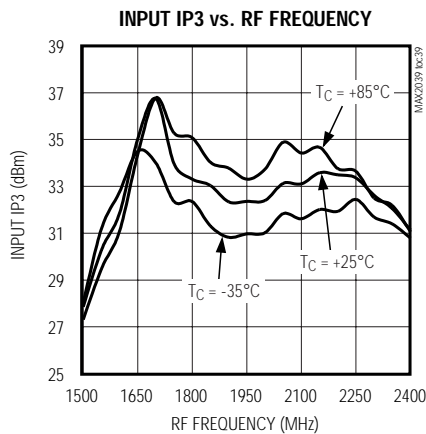
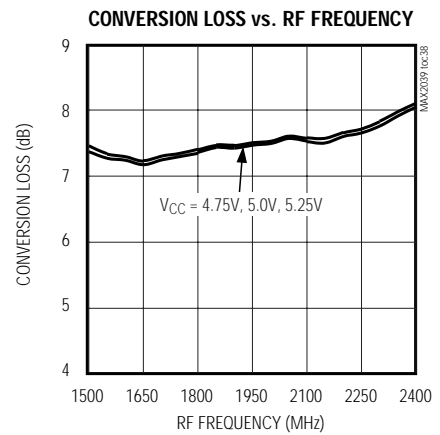
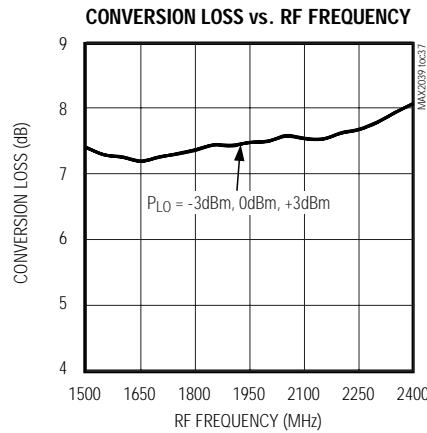
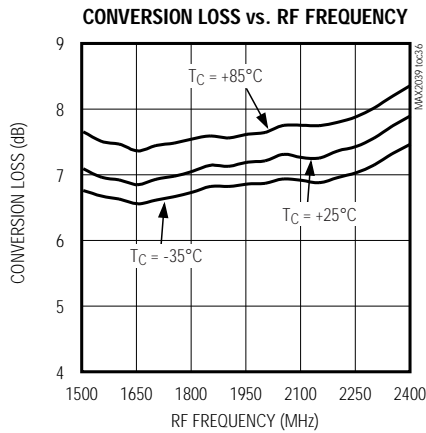

# High-Linearity, 1700MHz to 2200MHz Upconversion/Downconversion Mixer with LO Buffer/Switch

## Typical Operating Characteristics (continued)

(MAX2039 Typical Application Circuit,  $V_{CC} = +5.0V$ ,  $P_{LO} = 0dBm$ ,  $P_{IF} = 0dBm$ ,  $f_{RF} = f_{LO} + f_{IF}$ ,  $f_{IF} = 200MHz$ ,  $R_1 = 549\Omega$ , unless otherwise noted.)

### Upconverter Curves

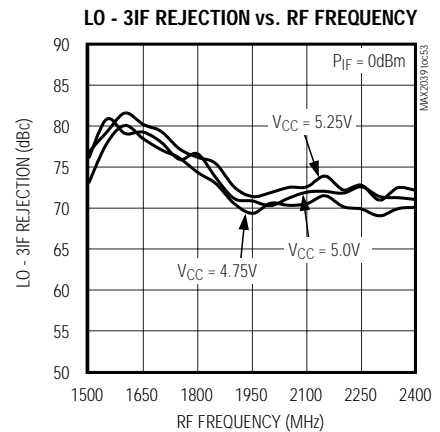
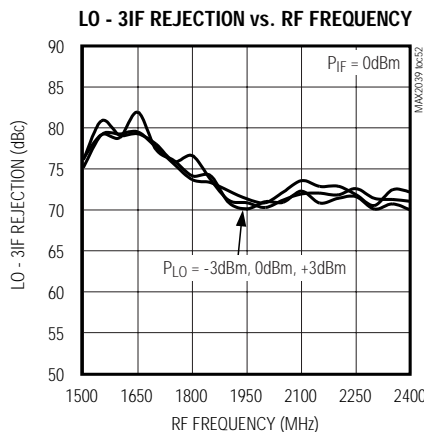
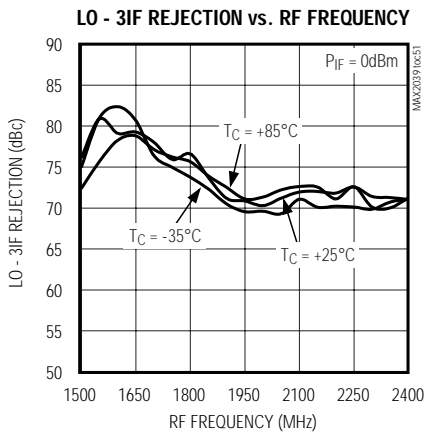
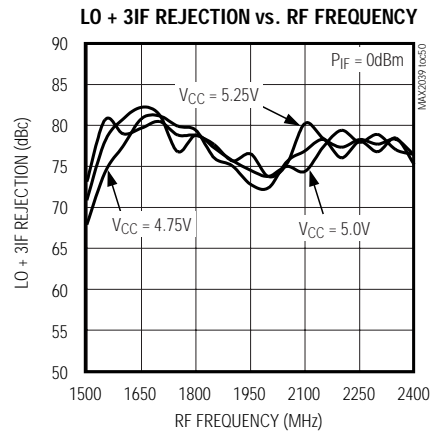
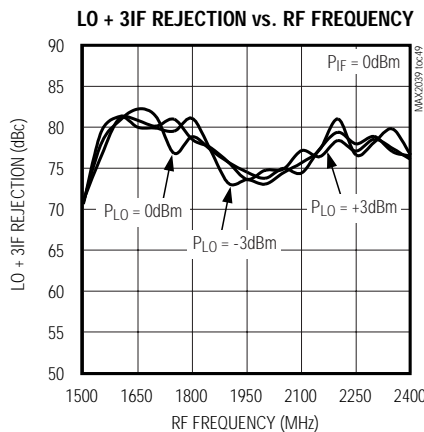
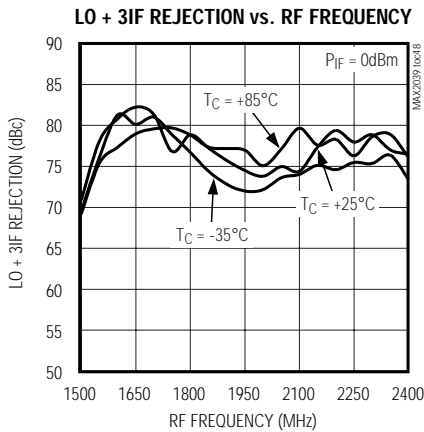
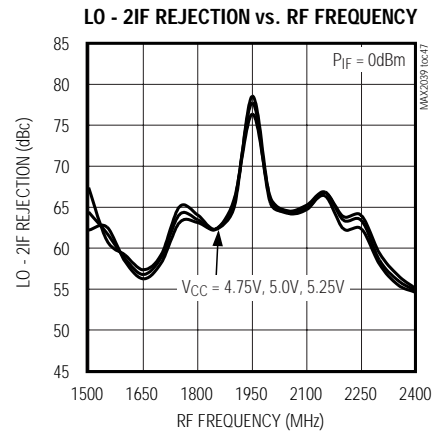
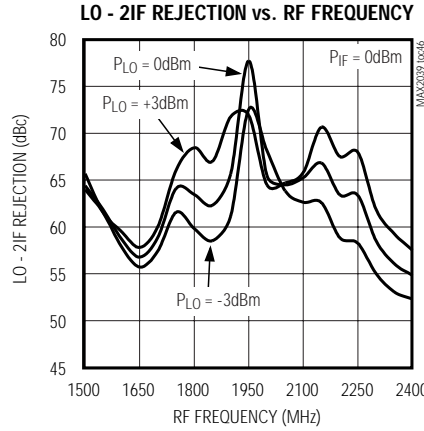
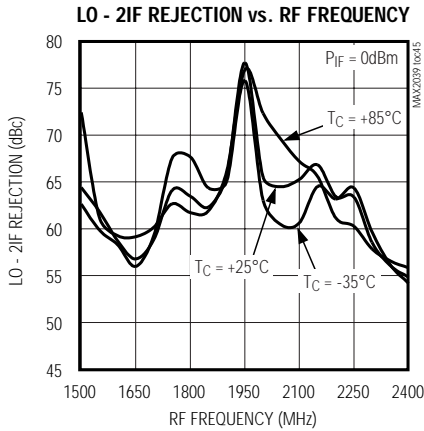

# High-Linearity, 1700MHz to 2200MHz Upconversion/Downconversion Mixer with LO Buffer/Switch

## Typical Operating Characteristics (continued)

(MAX2039 Typical Application Circuit,  $V_{CC} = +5.0V$ ,  $P_{LO} = 0dBm$ ,  $P_{IF} = 0dBm$ ,  $f_{RF} = f_{LO} + f_{IF}$ ,  $f_{IF} = 200MHz$ ,  $R_1 = 549\Omega$ , unless otherwise noted.)

### Upconverter Curves

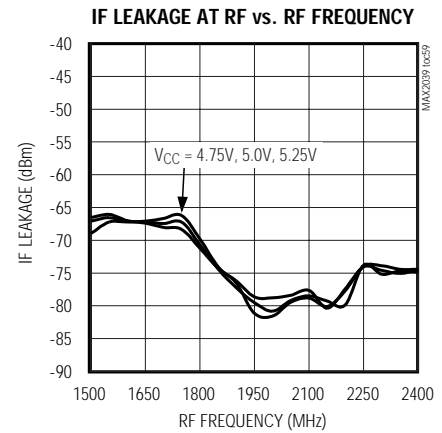
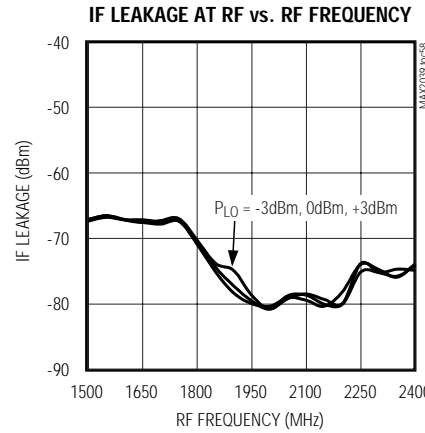
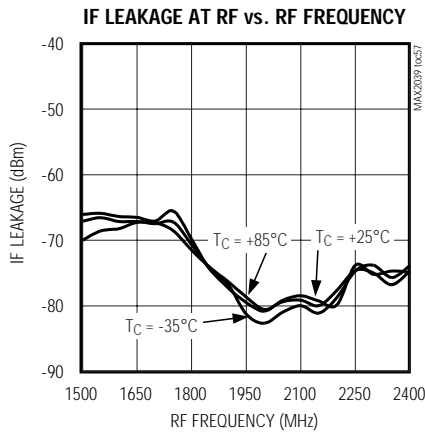
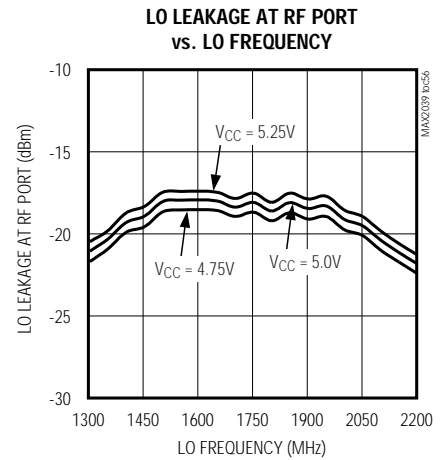
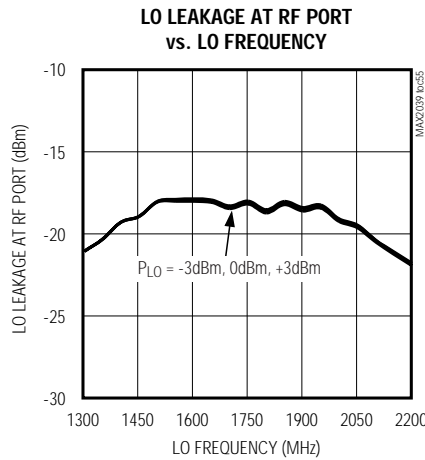
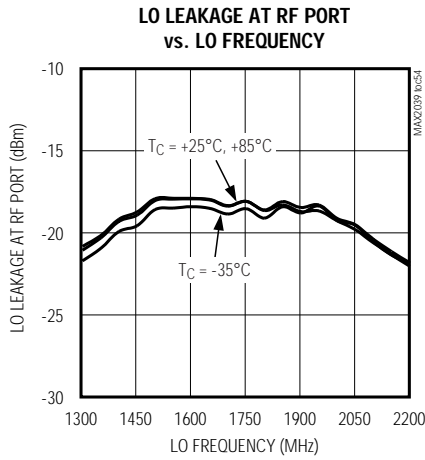

# High-Linearity, 1700MHz to 2200MHz Upconversion/ Downconversion Mixer with LO Buffer/Switch

## Pin Description

PIN	NAME	FUNCTION
1, 6, 8, 14	VCC	Power-Supply Connection. Bypass each VCC pin to GND with capacitors as shown in the <i>Typical Application Circuit</i> .
2	RF	Single-Ended 50 $\Omega$ RF Input/Output. This port is internally matched and DC shorted to GND through a balun.
3	TAP	Center Tap of the Internal RF Balun. Bypass to GND with capacitors close to the IC, as shown in the <i>Typical Application Circuit</i> .
4, 5, 10, 12, 13, 16, 17, 20	GND	Ground
7	LOBIAS	Bias Resistor for Internal LO Buffer. Connect a 549 $\Omega$ 1% resistor from LOBIAS to the power supply.
9	LOSEL	Local Oscillator Select. Logic control input for selecting LO1 or LO2.
11	LO1	Local Oscillator Input 1. Drive LOSEL low to select LO1.
15	LO2	Local Oscillator Input 2. Drive LOSEL high to select LO2.
18, 19	IF-, IF+	Differential IF Input/Outputs
EP	GND	Exposed Ground Paddle. Solder the exposed paddle to the ground plane using multiple vias.

## Detailed Description

The MAX2039 can operate either as a downconverter or an upconverter mixer that provides 7.1dB of conversion loss with a typical 7.3dB noise figure. IIP3 is +33.5dBm for upconversion and +34.5dBm for downconversion. The integrated baluns and matching circuitry allow for 50 $\Omega$  single-ended interfaces to the RF port and two LO ports. The RF port can be used as an input for downconversion or an output for upconversion. A single-pole, double-throw (SPDT) switch provides 50ns switching time between the two LO inputs with 45dB of LO-to-LO isolation. Furthermore, the integrated LO buffer provides a high drive level to the mixer core, reducing the LO drive required at the MAX2039's inputs to a range of -3dBm to +3dBm. The IF port incorporates a differential output for downconversion, which is ideal for providing enhanced IIP2 performance. For upconversion, the IF port is a differential input.

Specifications are guaranteed over broad frequency ranges to allow for use in UMTS, cdma2000, and 2G/2.5G/3G DCS1800, and PCS1900 base stations. The MAX2039 is specified to operate over an RF frequency range of 1700MHz to 2200MHz, an LO frequency range of 1500MHz to 2000MHz, and an IF frequency range of DC to 350MHz. Operation beyond these ranges is possible; see the *Typical Operating Characteristics* for additional details.

This device can operate in high-side LO injection applications with an extended LO range, but performance degrades as  $f_{LO}$  continues to increase. See the *Typical Operating Characteristics* for measurements taken with  $f_{LO}$  up to 2200MHz. For a device with better high-side LO injection performance, contact the factory.

### RF Port and Balun

For using the MAX2039 as a downconverter, the RF input is internally matched to 50 $\Omega$ , requiring no external matching components. A DC-blocking capacitor is required since the input is internally DC shorted to ground through the on-chip balun. The RF return loss is typically 18dB over the entire 1700MHz to 2200MHz RF frequency range. For upconverter operation, the RF port is a single-ended output similarly matched to 50 $\Omega$ .

### LO Inputs, Buffer, and Balun

The MAX2039 can be used for either high-side or low-side injection applications with a 1500MHz to 2000MHz LO frequency range. For a device with a 1900MHz to 2400MHz LO frequency range, contact the factory. As an added feature, the MAX2039 includes an internal LO SPDT switch that can be used for frequency-hopping applications. The switch selects one of the two single-ended LO ports, allowing the external oscillator to settle on a particular frequency before it is switched in. LO switching time is typically less than 50ns, which is more than adequate for virtually all GSM applications.

# High-Linearity, 1700MHz to 2200MHz Upconversion/ Downconversion Mixer with LO Buffer/Switch

If frequency hopping is not employed, set the switch to either of the LO inputs. The switch is controlled by a digital input (LOSEL): logic high selects LO2, logic low selects LO1. In order to avoid damage to the part, voltage **MUST** be applied to VCC before digital logic is applied to LOSEL (see the *Absolute Maximum Ratings*). LO1 and LO2 inputs are internally matched to 50Ω, requiring only a 22pF DC-blocking capacitor.

A two-stage internal LO buffer allows a wide-input power range for the LO drive. All guaranteed specifications are for an LO signal power from -3dBm to +3dBm. The on-chip low-loss balun, along with an LO buffer, drives the double-balanced mixer. All interfacing and matching components from the LO inputs to the IF outputs are integrated on chip.

### High-Linearity Mixer

The core of the MAX2039 is a double-balanced, high-performance passive mixer. Exceptional linearity is provided by the large LO swing from the on-chip LO buffer.

### Differential IF

The MAX2039 mixer has an IF frequency range of DC to 350MHz. Note that these differential ports are ideal for providing enhanced IIP2 performance. Single-ended IF applications require a 1:1 balun to transform the 50Ω differential IF impedance to a 50Ω single-ended system. After the balun, the IF return loss is better than 15dB. The differential IF is used as an input port for upconverter operation. The user can use a differential IF amplifier following the mixer but a DC block is required on both IF pins. In this configuration, the IF+ and IF- pins need to be returned to ground through a high resistance (about 1kΩ). This ground return can also be accomplished by grounding the RF TAP (pin 3) and AC-coupling the IF+ and IF- ports (pins 19 and 18).

## Applications Information

### Input and Output Matching

The RF and LO inputs are internally matched to 50Ω. No matching components are required. Return loss at the RF port is typically 18dB over the entire input range (1700MHz to 2200MHz) and return loss at the LO ports is typically 16dB (1500MHz to 2000MHz). RF and LO inputs require only DC-blocking capacitors for interfacing.

The IF output impedance is 50Ω (differential). For evaluation, an external low-loss 1:1 (impedance ratio) balun

**Table 1. Component List Referring to the Typical Application Circuit**

COMPONENT	VALUE	DESCRIPTION
C1	4pF	Microwave capacitor (0603)
C4	10pF	Microwave capacitor (0603)
C2, C6, C7, C8, C10, C12	22pF	Microwave capacitors (0603)
C3, C5, C9, C11	0.01μF	Microwave capacitors (0603)
R1	549Ω	±1% resistor (0603)
T1	1:1 Balun	IF balun with DC grounded ports
U1	MAX2039	Maxim IC

transforms this impedance to a 50Ω single-ended output (see the *Typical Application Circuit*).

### Bias Resistor

Bias current for the LO buffer is optimized by fine tuning resistor R1. If reduced current is required at the expense of performance, contact the factory for details. If the ±1% bias resistor values are not readily available, substitute standard ±5% values.

### Layout Considerations

A properly designed PC board is an essential part of any RF/microwave circuit. Keep RF signal lines as short as possible to reduce losses, radiation, and inductance. For the best performance, route the ground pin traces directly to the exposed pad under the package. The PC board exposed pad **MUST** be connected to the ground plane of the PC board. It is suggested that multiple vias be used to connect this pad to the lower-level ground planes. This method provides a good RF/thermal conduction path for the device. Solder the exposed pad on the bottom of the device package to the PC board. The MAX2039 Evaluation Kit can be used as a reference for board layout. Gerber files are available upon request at [www.maxim-ic.com](http://www.maxim-ic.com).

### Power-Supply Bypassing

Proper voltage-supply bypassing is essential for high-frequency circuit stability. Bypass each VCC pin and TAP with the capacitors shown in the *Typical Application Circuit*; see Table 1. Place the TAP bypass capacitor to ground within 100 mils of the TAP pin.

# High-Linearity, 1700MHz to 2200MHz Upconversion/Downconversion Mixer with LO Buffer/Switch

Typical Application Circuit

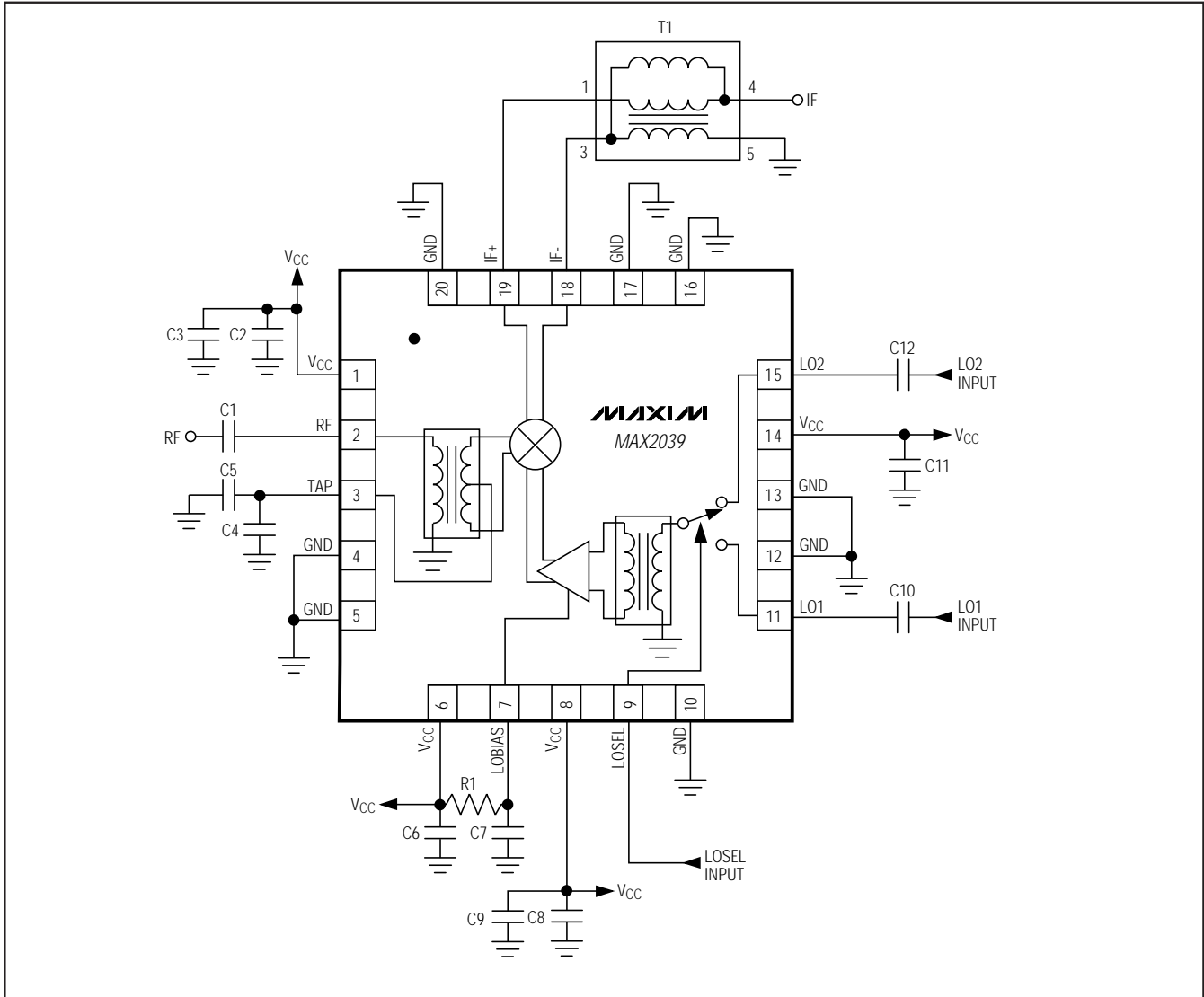

### Exposed Pad RF/Thermal Considerations

The EP of the MAX2039's 20-pin thin QFN-EP package provides a low thermal-resistance path to the die. It is important that the PC board on which the MAX2039 is mounted be designed to conduct heat from the EP. In addition, provide the EP with a low-inductance path to electrical ground. The EP **MUST** be soldered to a ground plane on the PC board, either directly or through an array of plated via holes.

### Chip Information

TRANSISTOR COUNT: 1212

PROCESS: SiGe BiCMOS

# High-Linearity, 1700MHz to 2200MHz Upconversion/ Downconversion Mixer with LO Buffer/Switch

## Pin Configuration

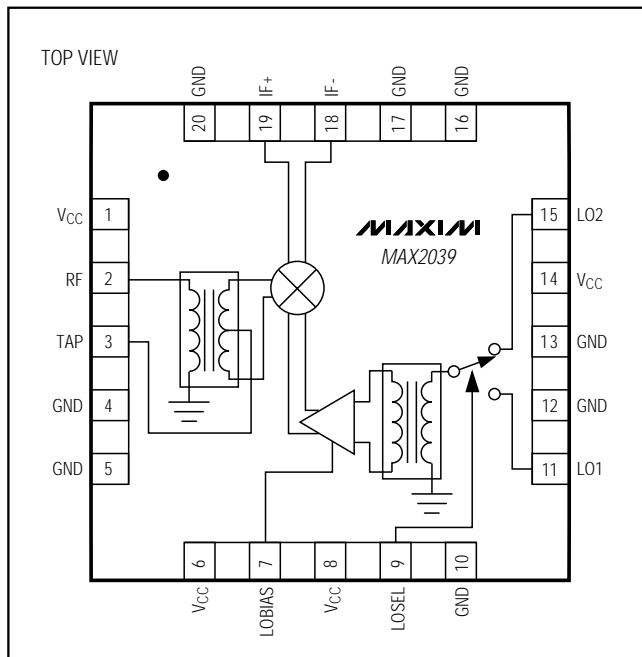

MAX2039

# High-Linearity, 1700MHz to 2200MHz Upconversion/Downconversion Mixer with LO Buffer/Switch

## Package Information

(The package drawing(s) in this data sheet may not reflect the most current specifications. For the latest package outline information, go to [www.maxim-ic.com/packages](http://www.maxim-ic.com/packages).)

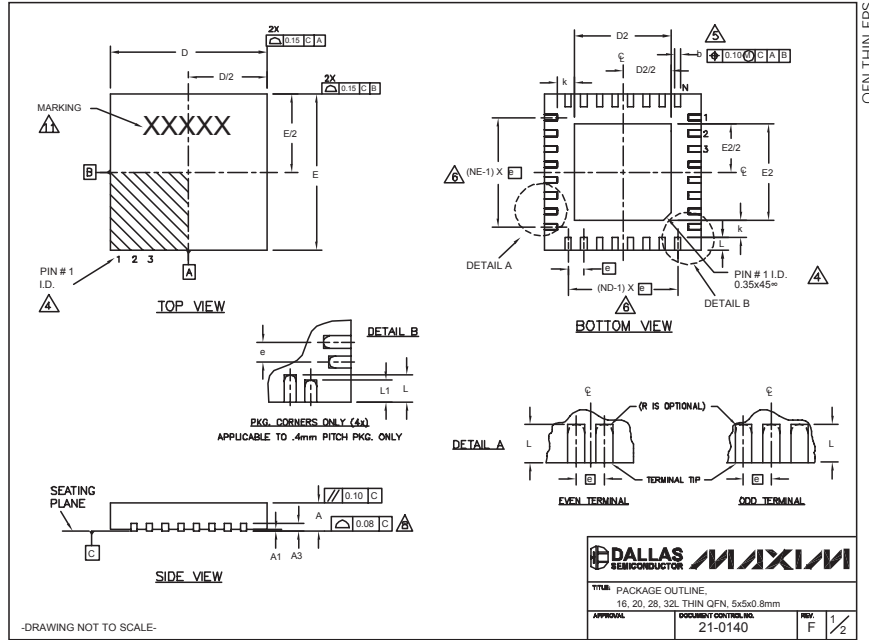

COMMON DIMENSIONS												
PKG.	16L 5x5			20L 5x5			28L 5x5			32L 5x5		
SYMBOL	MIN.	NOM.	MAX.	MIN.	NOM.	MAX.	MIN.	NOM.	MAX.	MIN.	NOM.	MAX.
A	0.70	0.75	0.80	0.70	0.75	0.80	0.70	0.75	0.80	0.70	0.75	0.80
A1	0	0.02	0.05	0	0.02	0.05	0	0.02	0.05	0	0.02	0.05
A3	0.20 REF.			0.20 REF.			0.20 REF.			0.20 REF.		
b	0.25	0.30	0.35	0.25	0.30	0.35	0.20	0.25	0.30	0.20	0.25	0.30
D	4.90	5.00	5.10	4.90	5.00	5.10	4.90	5.00	5.10	4.90	5.00	5.10
E	4.90	5.00	5.10	4.90	5.00	5.10	4.90	5.00	5.10	4.90	5.00	5.10
e	0.80 BSC.			0.65 BSC.			0.50 BSC.			0.50 BSC.		
k	0.25	-	-	0.25	-	-	0.25	-	-	0.25	-	-
L	0.30	0.40	0.50	0.45	0.55	0.65	0.45	0.55	0.65	0.30	0.40	0.50
L1	-	-	-	-	-	-	-	-	-	-	-	-
N	16			20			28			32		
ND	4			5			7			8		
NE	4			5			7			8		
JEDEC	WHHB			WHHC			WHHD-1			WHHD-2		

EXPOSED PAD VARIATIONS									
PKG. CODES	D2			E2			L	DOWN BONDS ALLOWED	
	MIN.	NOM.	MAX.	MIN.	NOM.	MAX.	±0.15		
T1655-1	3.00	3.10	3.20	3.00	3.10	3.20	**	NO	
T1655-2	3.00	3.10	3.20	3.00	3.10	3.20	**	YES	
T1655N-1	3.00	3.10	3.20	3.00	3.10	3.20	**	NO	
T2055-2	3.00	3.10	3.20	3.00	3.10	3.20	**	NO	
T2055-3	3.00	3.10	3.20	3.00	3.10	3.20	**	YES	
T2055-4	3.00	3.10	3.20	3.00	3.10	3.20	**	NO	
T2055-5	3.15	3.25	3.35	3.15	3.25	3.35	0.40	Y	
T2855-1	3.15	3.25	3.35	3.15	3.25	3.35	**	NO	
T2855-2	2.60	2.70	2.80	2.60	2.70	2.80	**	NO	
T2855-3	3.15	3.25	3.35	3.15	3.25	3.35	**	YES	
T2855-4	2.60	2.70	2.80	2.60	2.70	2.80	**	YES	
T2855-5	2.60	2.70	2.80	2.60	2.70	2.80	**	NO	
T2855-6	3.15	3.25	3.35	3.15	3.25	3.35	**	NO	
T2855-7	2.60	2.70	2.80	2.60	2.70	2.80	**	YES	
T2855-8	3.15	3.25	3.35	3.15	3.25	3.35	0.40	Y	
T2855N-1	3.15	3.25	3.35	3.15	3.25	3.35	**	N	
T3255-2	3.00	3.10	3.20	3.00	3.10	3.20	**	NO	
T3255-3	3.00	3.10	3.20	3.00	3.10	3.20	**	YES	
T3255-4	3.00	3.10	3.20	3.00	3.10	3.20	**	NO	
T3255N-1	3.00	3.10	3.20	3.00	3.10	3.20	**	NO	

NOTES:

- DIMENSIONING & TOLERANCING CONFORM TO ASME Y14.5M-1994.
- ALL DIMENSIONS ARE IN MILLIMETERS. ANGLES ARE IN DEGREES.
- N IS THE TOTAL NUMBER OF TERMINALS.
- THE TERMINAL #1 IDENTIFIER AND TERMINAL NUMBERING CONVENTION SHALL CONFORM TO JEDEC S-1 SPP-012. DETAILS OF TERMINAL #1 IDENTIFIER ARE OPTIONAL, BUT MUST BE LOCATED WITHIN THE ZONE INDICATED. THE TERMINAL #1 IDENTIFIER MAY BE EITHER A MOLD OR MARKED FEATURE.
- DIMENSION b APPLIES TO METALLIZED TERMINAL AND IS MEASURED BETWEEN 0.25 mm AND 0.30 mm FROM TERMINAL TIP.
- ND AND NE REFER TO THE NUMBER OF TERMINALS ON EACH D AND E SIDE RESPECTIVELY.
- DEPOPULATION IS POSSIBLE IN A SYMMETRICAL FASHION.
- COPLANARITY APPLIES TO THE EXPOSED HEAT SINK SLUG AS WELL AS THE TERMINALS.
- DRAWING CONFORMS TO JEDEC MO220, EXCEPT EXPOSED PAD DIMENSION FOR T2855-1, T2855-3 AND T2855-6.
- WARPAGE SHALL NOT EXCEED 0.10 mm.
- MARKING IS FOR PACKAGE ORIENTATION REFERENCE ONLY.
- NUMBER OF LEADS SHOWN ARE FOR REFERENCE ONLY.

APPROVAL: [Signature] DOCUMENT CONTROL NO.: 21-0140 REV. F 2/2

Maxim cannot assume responsibility for use of any circuitry other than circuitry entirely embodied in a Maxim product. No circuit patent licenses are implied. Maxim reserves the right to change the circuitry and specifications without notice at any time.

16 Maxim Integrated Products, 120 San Gabriel Drive, Sunnyvale, CA 94086 408-737-7600