

The RF Sub-Micron MOSFET Line
RF Power Field Effect Transistor
N-Channel Enhancement-Mode Lateral MOSFET

MRF5P21240R6

Designed for W-CDMA base station applications with frequencies from 2110 to 2170 MHz. Suitable for TDMA, CDMA and multicarrier amplifier applications. To be used in Class AB for PCN-PCS/cellular radio and WLL applications.

**2170 MHz, 52 W AVG.,
2 x W-CDMA, 28 V
LATERAL N-CHANNEL
RF POWER MOSFET**

- Typical 2-carrier W-CDMA Performance for $V_{DD} = 28$ Volts, $I_{DQ} = 2 \times 1100$ mA, $f_1 = 2135$ MHz, $f_2 = 2145$ MHz, Channel Bandwidth = 3.84 MHz, Adjacent Channels Measured over 3.84 MHz BW @ $f_1 - 5$ MHz and $f_2 + 5$ MHz. Distortion Products Measured over a 3.84 MHz BW @ $f_1 - 10$ MHz and $f_2 + 10$ MHz, Each Carrier Peak/Avg. = 8.5 dB @ 0.01% Probability on CCDF.
 - Output Power — 52 Watts Avg.
 - Power Gain — 13 dB
 - Efficiency — 24%
 - IM3 — -36 dBc
 - ACPR — -39 dBc
- Internally Matched, Controlled Q, for Ease of Use
- High Gain, High Efficiency and High Linearity
- Integrated ESD Protection
- Designed for Maximum Gain and Insertion Phase Flatness
- Capable of Handling 5:1 VSWR, @ 28 Vdc, $f = 2140$ MHz, 180 Watts CW Output Power
- Excellent Thermal Stability
- Characterized with Series Equivalent Large-Signal Impedance Parameters
- In Tape and Reel. R6 Suffix = 150 Units per 56 mm, 13 inch Reel.

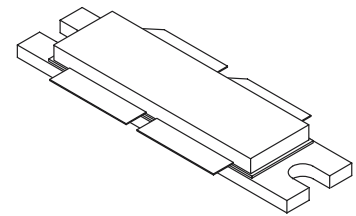

**CASE 375D-04, STYLE 1
NI-1230**

MAXIMUM RATINGS

Rating	Symbol	Value	Unit
Drain-Source Voltage	V_{DSS}	65	Vdc
Gate-Source Voltage	V_{GS}	-0.5, +15	Vdc
Total Device Dissipation @ $T_C = 25^\circ\text{C}$ Derate above 25°C	P_D	500 2.86	Watts W/ $^\circ\text{C}$
Storage Temperature Range	T_{stg}	-65 to +150	$^\circ\text{C}$
Operating Junction Temperature	T_J	200	$^\circ\text{C}$
CW Operation	CW	180	Watts

THERMAL CHARACTERISTICS

Characteristic	Symbol	Max	Unit
Thermal Resistance, Junction to Case Case Temperature 55°C , 180 W CW Case Temperature 45°C , 52 W CW	$R_{\theta JC}$	0.35 0.40	$^\circ\text{C}/\text{W}$

NOTE – **CAUTION** – MOS devices are susceptible to damage from electrostatic charge. Reasonable precautions in handling and packaging MOS devices should be observed.

ESD PROTECTION CHARACTERISTICS

Test Conditions	Class
Human Body Model	2 (Minimum)
Machine Model	M3 (Minimum)
Charge Device Model	C6 (Minimum)

ELECTRICAL CHARACTERISTICS (T_C = 25°C unless otherwise noted)

Characteristic	Symbol	Min	Typ	Max	Unit
----------------	--------	-----	-----	-----	------

OFF CHARACTERISTICS (1)

Zero Gate Voltage Drain Leakage Current (V _{DS} = 65 Vdc, V _{GS} = 0 Vdc)	I _{DSS}	—	—	10	μA _{dc}
Zero Gate Voltage Drain Leakage Current (V _{DS} = 28 Vdc, V _{GS} = 0 Vdc)	I _{DSS}	—	—	1	μA _{dc}
Gate–Source Leakage Current (V _{GS} = 5 Vdc, V _{DS} = 0 Vdc)	I _{GSS}	—	—	1	μA _{dc}

ON CHARACTERISTICS (1)

Gate Threshold Voltage (V _{DS} = 10 Vdc, I _D = 300 μA _{dc})	V _{GS(th)}	2	2.8	4	Vdc
Gate Quiescent Voltage (V _{DS} = 28 Vdc, I _D = 1100 mA _{dc})	V _{GS(Q)}	3	3.8	5	Vdc
Drain–Source On–Voltage (V _{GS} = 10 Vdc, I _D = 3 A _{dc})	V _{DS(on)}	—	0.26	0.3	Vdc
Forward Transconductance (V _{DS} = 10 Vdc, I _D = 3 A _{dc})	g _{fs}	—	7.5	—	S

DYNAMIC CHARACTERISTICS (1)

Reverse Transfer Capacitance (V _{DS} = 28 Vdc, V _{GS} = 0, f = 1 MHz)	C _{r_{ss}}	—	2.75	—	pF
--	-----------------------------	---	------	---	----

FUNCTIONAL TESTS (In Motorola Test Fixture, 50 ohm system) (2)

2–Carrier W–CDMA, 3.84 MHz Channel Bandwidth Carriers. Each carrier has Peak/Avg. ratio = 8.5 dB @ 0.01% Probability on CCDF.

Common–Source Amplifier Power Gain (V _{DD} = 28 Vdc, P _{out} = 52 W Avg., I _{DQ} = 2 x 1100 mA, f ₁ = 2112.5 MHz, f ₂ = 2122.5 MHz and f ₁ = 2157.5 MHz, f ₂ = 2167.5 MHz)	G _{ps}	12	13	—	dB
Drain Efficiency (V _{DD} = 28 Vdc, P _{out} = 52 W Avg., I _{DQ} = 2 x 1100 mA, f ₁ = 2112.5 MHz, f ₂ = 2122.5 MHz and f ₁ = 2157.5 MHz, f ₂ = 2167.5 MHz)	η	22.5	24	—	%
Third Order Intermodulation Distortion (V _{DD} = 28 Vdc, P _{out} = 52 W Avg., I _{DQ} = 2 x 1100 mA, f ₁ = 2112.5 MHz, f ₂ = 2122.5 MHz and f ₁ = 2157.5 MHz, f ₂ = 2167.5 MHz; IM3 measured over 3.84 MHz BW @ f ₁ –10 MHz and f ₂ +10 MHz)	IM3	—	–36	–34	dBc
Adjacent Channel Power Ratio (V _{DD} = 28 Vdc, P _{out} = 52 W Avg., I _{DQ} = 2 x 1100 mA, f ₁ = 2112.5 MHz, f ₂ = 2122.5 MHz and f ₁ = 2157.5 MHz, f ₂ = 2167.5 MHz; ACPR measured over 3.84 MHz BW @ f ₁ –5 MHz and f ₂ +5 MHz.)	ACPR	—	–39	–37	dBc
Input Return Loss (V _{DD} = 28 Vdc, P _{out} = 52 W Avg., I _{DQ} = 2 x 1100 mA, f ₁ = 2112.5 MHz, f ₂ = 2122.5 MHz and f ₁ = 2157.5 MHz, f ₂ = 2167.5 MHz)	IRL	—	–12	–9	dB

(1) Each side of device measured separately. Part is internally matched both on input and output.

(2) Measurements made with device in push–pull configuration.

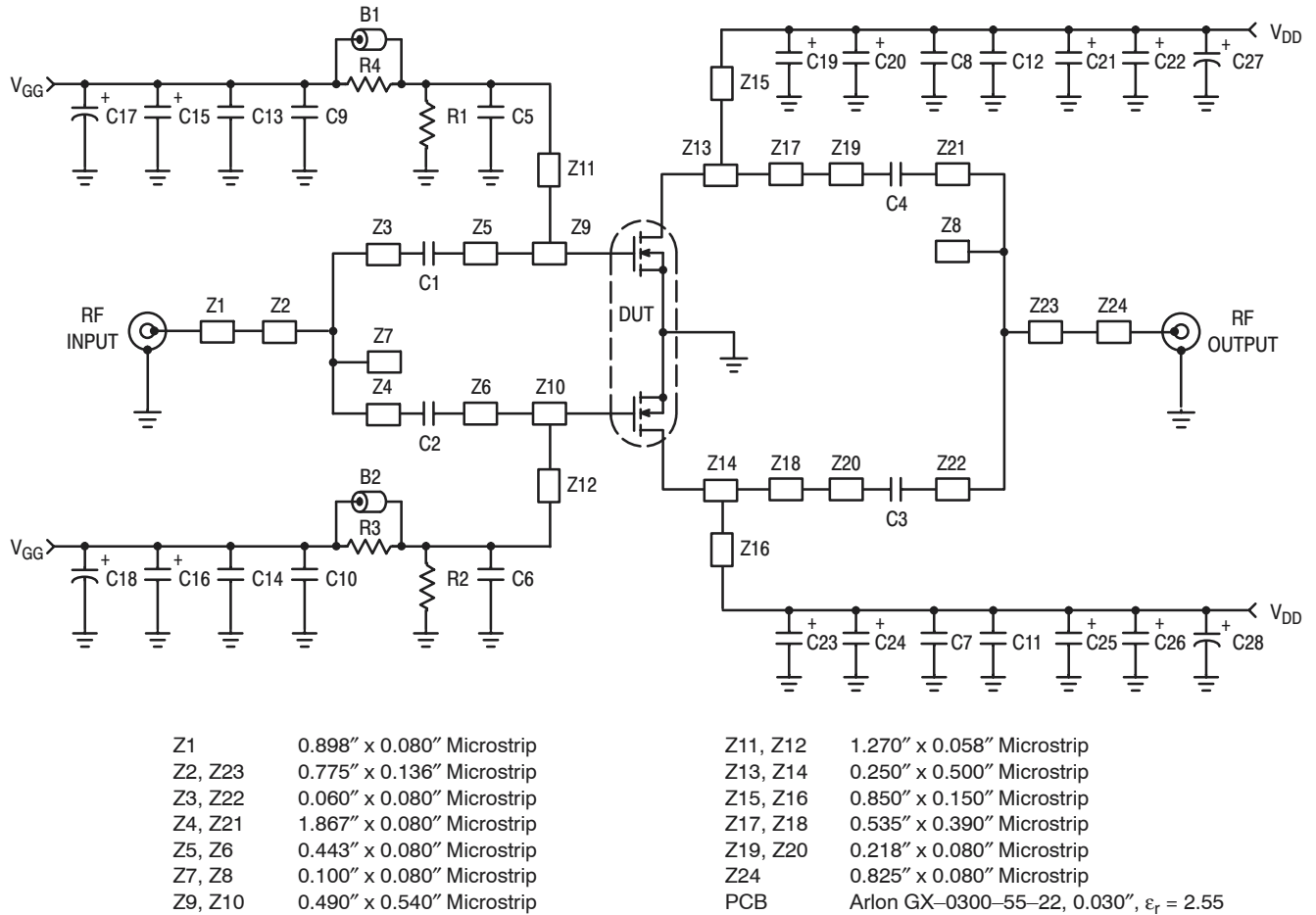

Figure 1. MRF5P21240R6 Test Circuit Schematic

Table 1. MRF5P21240R6 Test Circuit Component Designations and Values

Part	Description	Value, P/N or DWG	Manufacturer
B1, B2	Short Ferrite Beads	2743019447	Fair Rite
C1, C2, C3, C4	18 pF Chip Capacitors	100B180JCA500X	ATC
C5, C6, C7, C8	6.8 pF Chip Capacitors	100B6R8JCA500X	ATC
C9, C10, C11, C12	0.1 μ F Chip Capacitors	CDR33BX104AKWS	Kemet
C13, C14	1000 pF Chip Capacitors	100B102JCA500X	ATC
C15, C16	4.7 μ F Tantalum Capacitors	T491C475M050	Kemet
C17, C18	10 μ F Electrolytic Capacitors	EEV-HB1H100P	Panasonic
C19, C20, C21, C22 C23, C24, C25, C26	22 μ F Tantalum Capacitors	T491X226K035AS4394	Kemet
C27, C28	100 μ F Electrolytic Capacitors	517D107M050BB6A	Sprague
R1, R2	1.0 k Ω , 1/8 W Chip Resistors		
R3, R4	10 Ω , 1/8 W Chip Resistors		

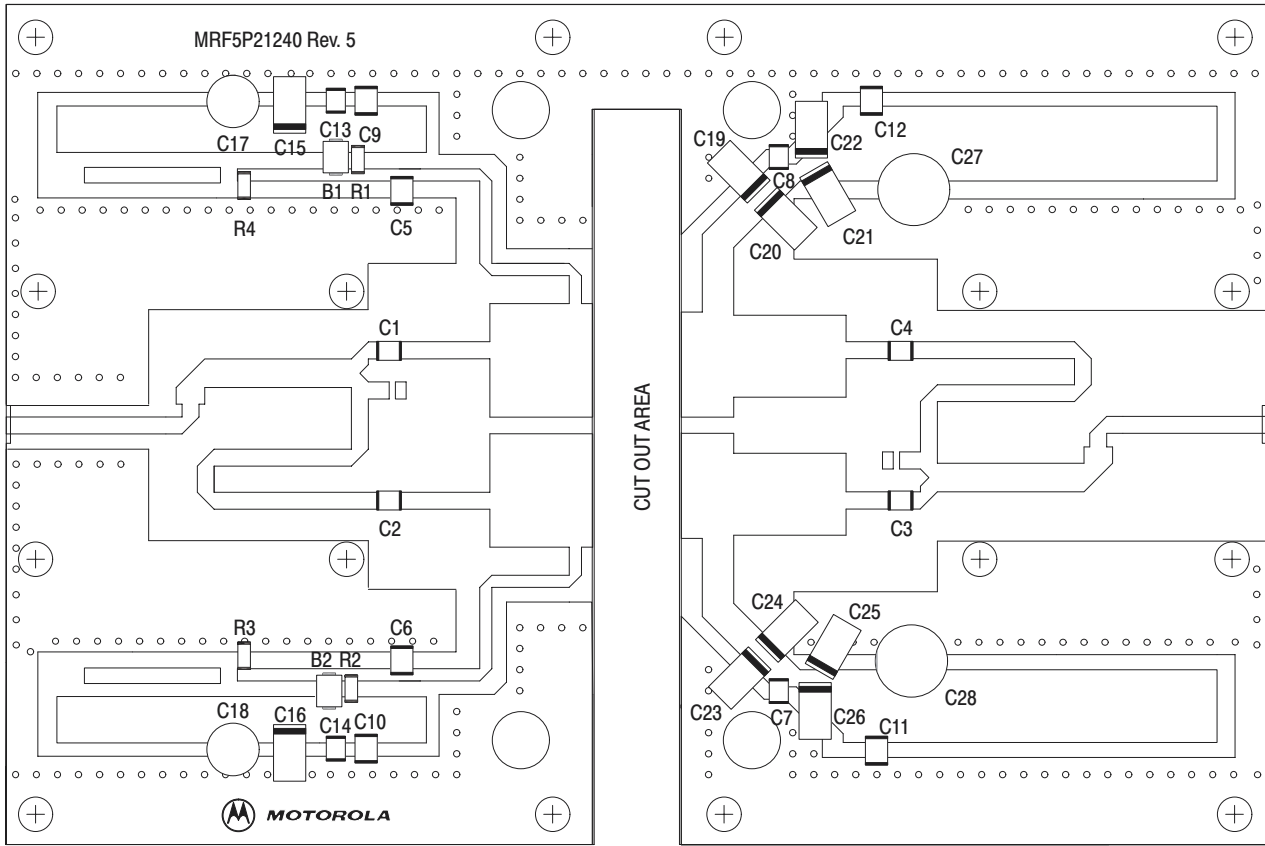

Figure 2. MRF5P21240R6 Test Circuit Component Layout

TYPICAL CHARACTERISTICS

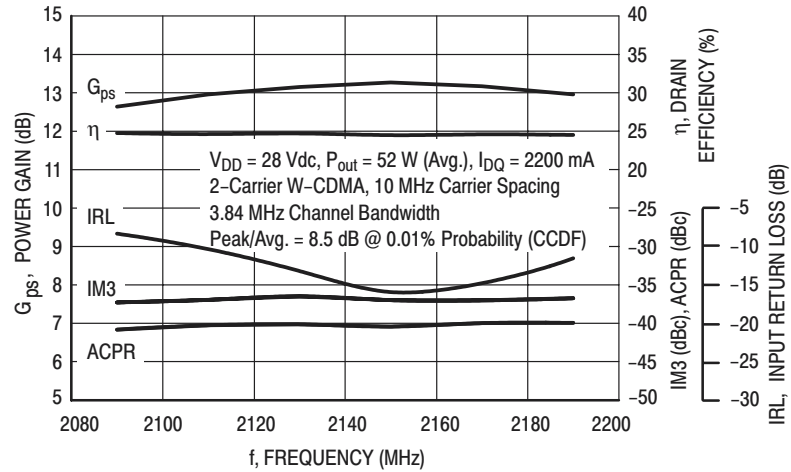

Figure 3. 2-Carrier W-CDMA Broadband Performance

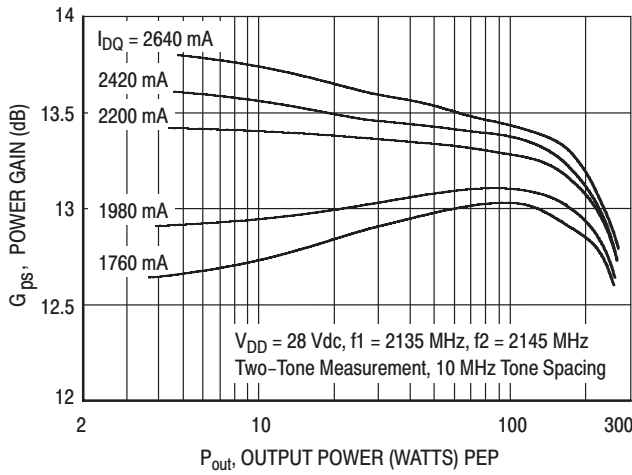

Figure 4. Two-Tone Power Gain versus Output Power

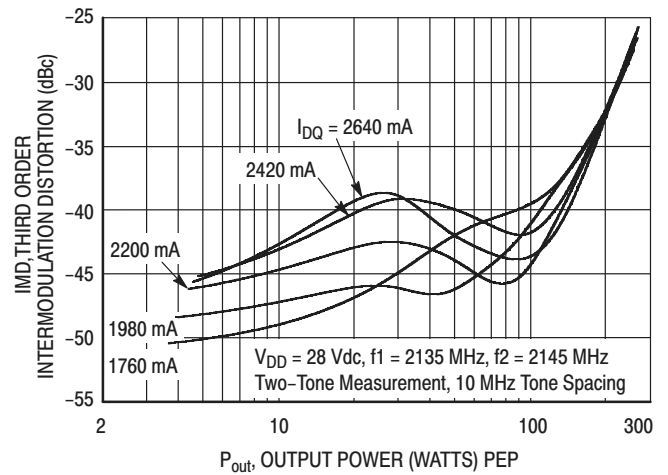

Figure 5. Third Order Intermodulation Distortion versus Output Power

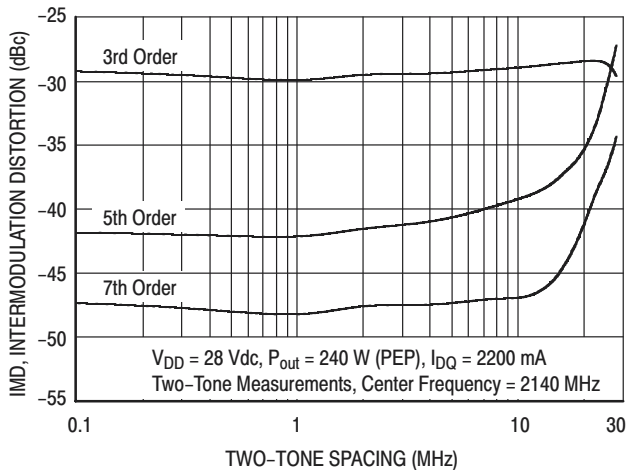

Figure 6. Intermodulation Distortion Products versus Tone Spacing

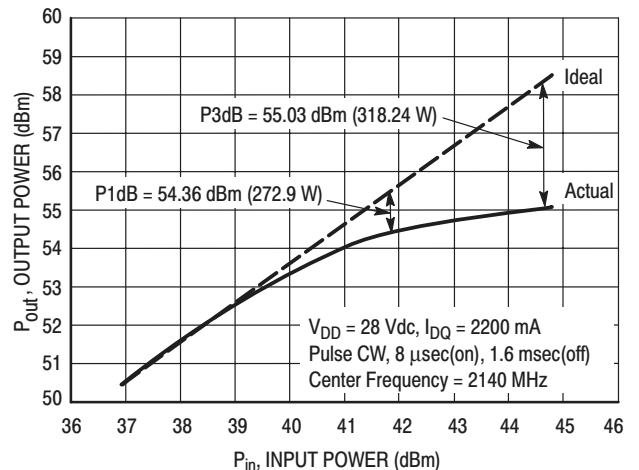

Figure 7. Pulse CW Output Power versus Input Power

TYPICAL CHARACTERISTICS

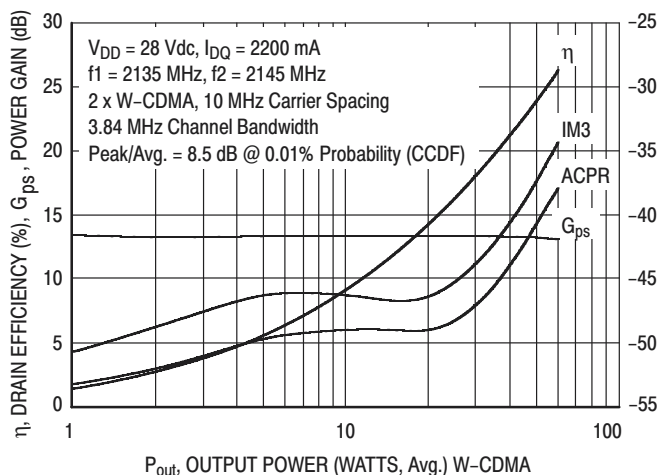

Figure 8. 2-Carrier W-CDMA ACPR, IM3, Power Gain and Drain Efficiency versus Output Power

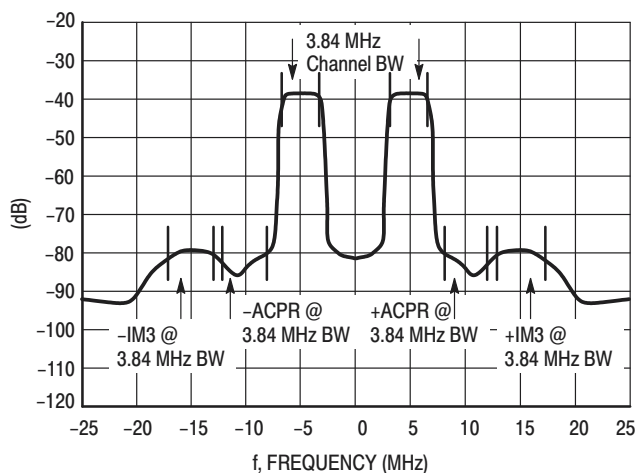

Figure 9. 2-Carrier W-CDMA Spectrum

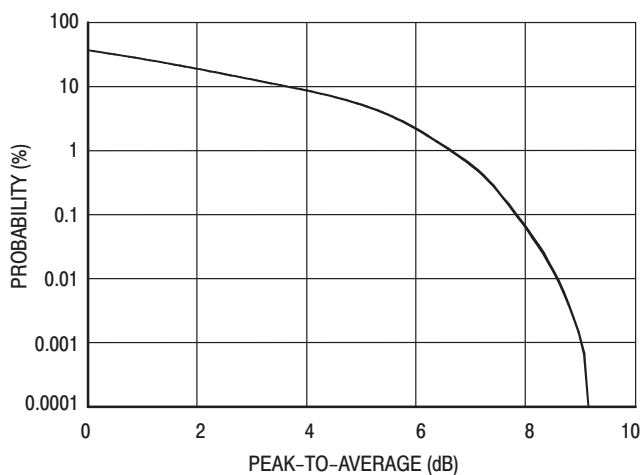
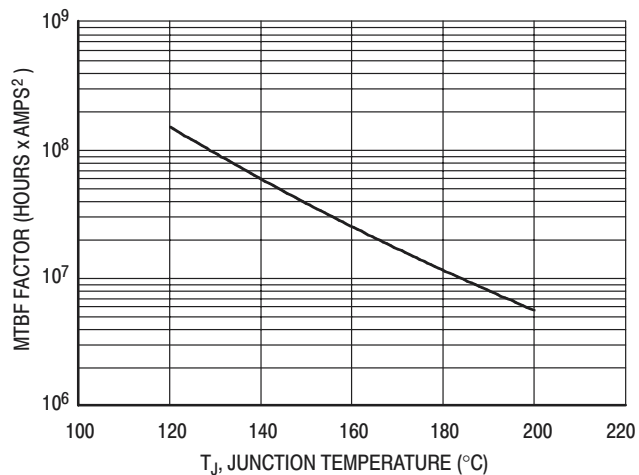
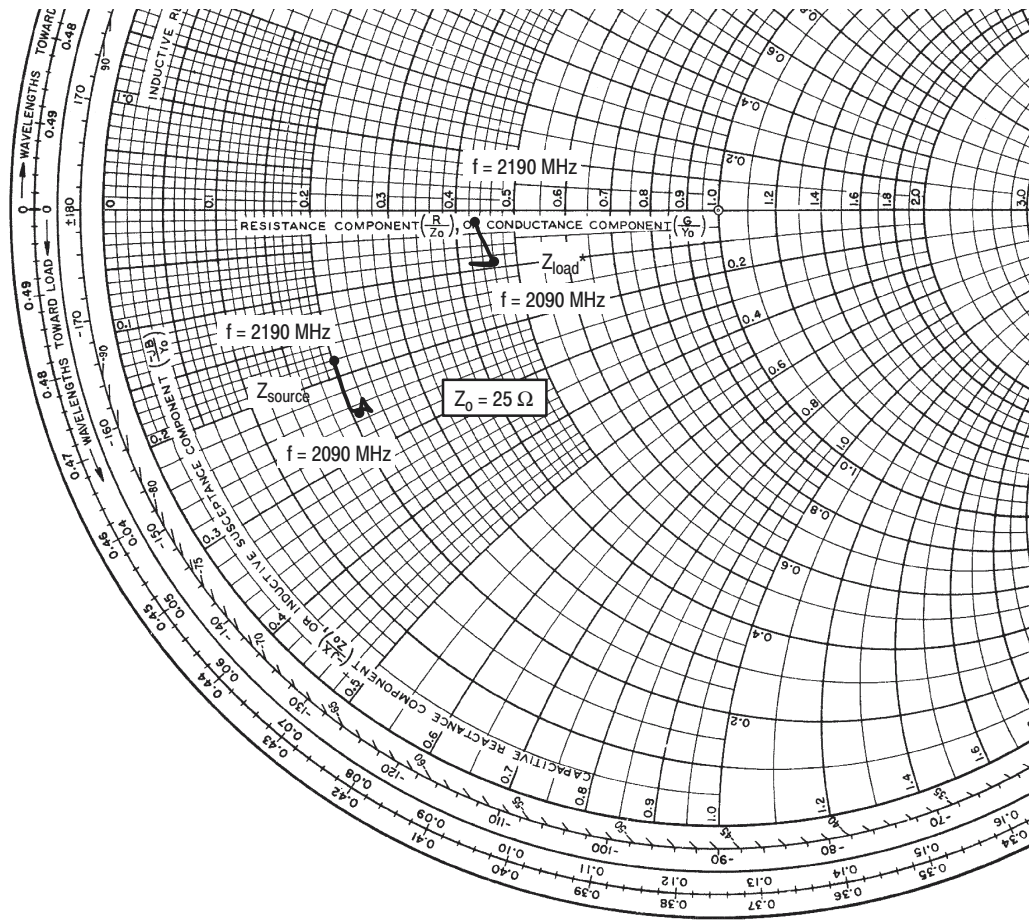

Figure 10. CCDF W-CDMA 3GPP, Test Model 1, 64 DPCH, 67% Clipping, Single Carrier Test Signal



This above graph displays calculated MTBF in hours x ampere² drain current. Life tests at elevated temperatures have correlated to better than $\pm 10\%$ of the theoretical prediction for metal failure. Divide MTBF factor by I_D^2 for MTBF in a particular application.

Figure 11. MTBF Factor versus Junction Temperature



$V_{DD} = 28\text{ V}$, $I_{DQ} = 2 \times 1100\text{ mA}$, $P_{out} = 52\text{ W Avg.}$

f MHz	Z_{source} Ω	Z_{load} Ω
2090	$5.33 - j6.21$	$11.42 - j2.25$
2110	$5.44 - j5.88$	$10.45 - j2.16$
2130	$5.40 - j6.16$	$11.28 - j2.14$
2150	$5.12 - j6.06$	$11.38 - j2.14$
2170	$4.96 - j5.25$	$11.04 - j1.25$
2190	$4.98 - j4.47$	$10.73 - j0.40$

Z_{source} = Test circuit impedance as measured from gate to gate, balanced configuration.

Z_{load} = Test circuit impedance as measured from drain to drain, balanced configuration.

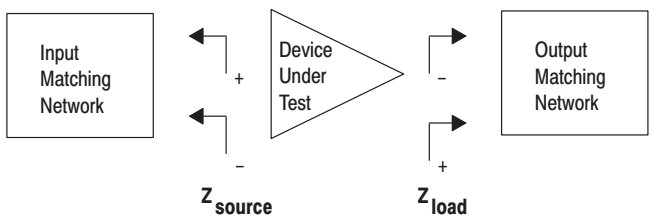
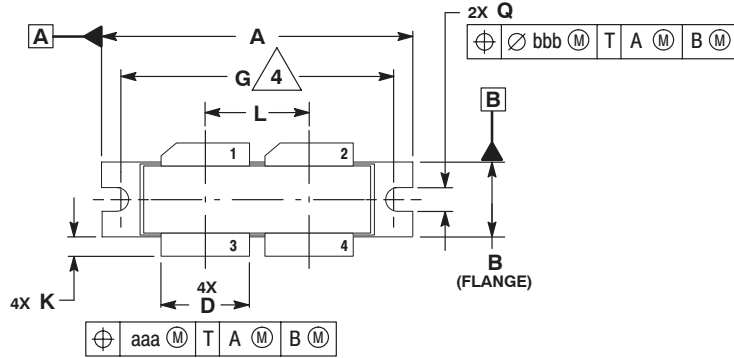

Figure 12. Series Equivalent Source and Load Impedance

PACKAGE DIMENSIONS



NOTES:

1. INTERPRET DIMENSIONS AND TOLERANCES PER ASME Y14.5M-1994.
2. CONTROLLING DIMENSION: INCH.
3. DIMENSION H IS MEASURED 0.030 (0.762) AWAY FROM PACKAGE BODY.
4. RECOMMENDED BOLT CENTER DIMENSION OF 1.52 (38.61) BASED ON M3 SCREW.

DIM	INCHES		MILLIMETERS	
	MIN	MAX	MIN	MAX
A	1.615	1.625	41.02	41.28
B	0.395	0.405	10.03	10.29
C	0.150	0.200	3.81	5.08
D	0.455	0.465	11.56	11.81
E	0.062	0.066	1.57	1.68
F	0.004	0.007	0.10	0.18
G	1.400 BSC		35.56 BSC	
H	0.079	0.089	2.01	2.26
K	0.117	0.137	2.97	3.48
L	0.540 BSC		13.72 BSC	
M	1.219	1.241	30.96	31.52
N	1.218	1.242	30.94	31.55
Q	0.120	0.130	3.05	3.30
R	0.355	0.365	9.01	9.27
S	0.365	0.375	9.27	9.53
aaa	0.013 REF		0.33 REF	
bbb	0.010 REF		0.25 REF	
ccc	0.020 REF		0.51 REF	

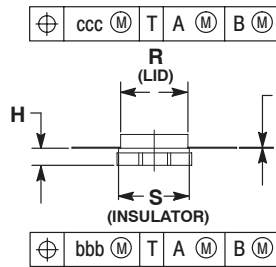
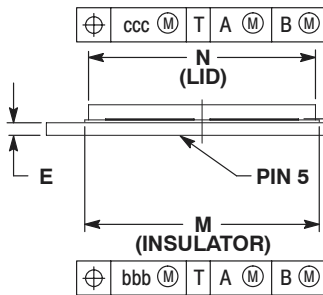

**CASE 375D-04
ISSUE C
NI-1230**

STYLE 1:

1. DRAIN
2. DRAIN
3. GATE
4. GATE
5. SOURCE

Information in this document is provided solely to enable system and software implementers to use Motorola products. There are no express or implied copyright licenses granted hereunder to design or fabricate any integrated circuits or integrated circuits based on the information in this document.

Motorola reserves the right to make changes without further notice to any products herein. Motorola makes no warranty, representation or guarantee regarding the suitability of its products for any particular purpose, nor does Motorola assume any liability arising out of the application or use of any product or circuit, and specifically disclaims any and all liability, including without limitation consequential or incidental damages. "Typical" parameters that may be provided in Motorola data sheets and/or specifications can and do vary in different applications and actual performance may vary over time. All operating parameters, including "Typicals", must be validated for each customer application by customer's technical experts. Motorola does not convey any license under its patent rights nor the rights of others. Motorola products are not designed, intended, or authorized for use as components in systems intended for surgical implant into the body, or other applications intended to support or sustain life, or for any other application in which the failure of the Motorola product could create a situation where personal injury or death may occur. Should Buyer purchase or use Motorola products for any such unintended or unauthorized application, Buyer shall indemnify and hold Motorola and its officers, employees, subsidiaries, affiliates, and distributors harmless against all claims, costs, damages, and expenses, and reasonable attorney fees arising out of, directly or indirectly, any claim of personal injury or death associated with such unintended or unauthorized use, even if such claim alleges that Motorola was negligent regarding the design or manufacture of the part.

MOTOROLA and the Stylized M Logo are registered in the US Patent and Trademark Office. All other product or service names are the property of their respective owners. Motorola, Inc. is an Equal Opportunity/Affirmative Action Employer.

© Motorola Inc. 2003

HOW TO REACH US:

USA/EUROPE/LOCATIONS NOT LISTED:
Motorola Literature Distribution
P.O. Box 5405, Denver, Colorado 80217
1-800-521-6274 or 480-768-2130

JAPAN: Motorola Japan Ltd.; SPS, Technical Information Center,
3-20-1, Minami-Azabu, Minato-ku, Tokyo 106-8573, Japan
81-3-3440-3569

ASIA/PACIFIC: Motorola Semiconductors H.K. Ltd.; Silicon Harbour Centre,
2 Dai King Street, Tai Po Industrial Estate, Tai Po, N.T., Hong Kong
852-26683334

HOME PAGE: <http://motorola.com/semiconductors>



MRF5P21240/D