

FS5VSH-3

HIGH-SPEED SWITCHING USE

FS5VSH-3



- 2.5V DRIVE
- V_{DSS} 150V
- r_{DS (ON)} (MAX) 0.35Ω
- I_D 5A
- Integrated Fast Recovery Diode (TYP.) 85ns

OUTLINE DRAWING

Dimensions in mm

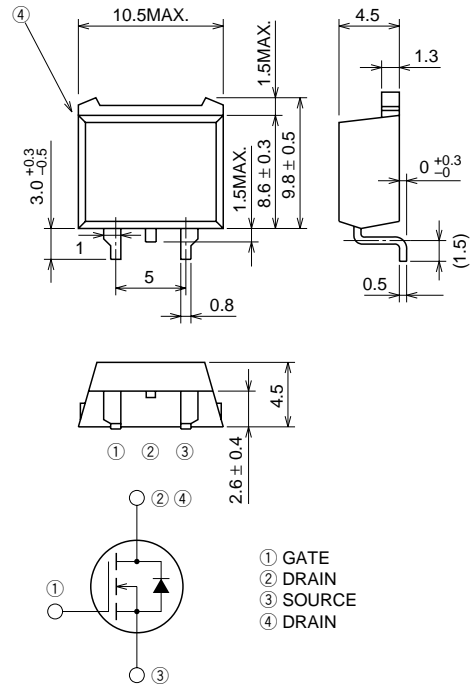

TO-220S

APPLICATION

Motor control, Lamp control, Solenoid control
DC-DC converter, etc.

MAXIMUM RATINGS (T_c = 25°C)

| Symbol | Parameter | Conditions | Ratings | Unit |
|------------------|----------------------------------|----------------------|------------|------|
| V _{DSS} | Drain-source voltage | V _{GS} = 0V | 150 | V |
| V _{GSS} | Gate-source voltage | V _{DS} = 0V | ±10 | V |
| I _D | Drain current | | 5 | A |
| I _{DM} | Drain current (Pulsed) | | 20 | A |
| I _{DA} | Avalanche drain current (Pulsed) | L = 100μH | 5 | A |
| I _S | Source current | | 5 | A |
| I _{SM} | Source current (Pulsed) | | 20 | A |
| P _D | Maximum power dissipation | | 30 | W |
| T _{ch} | Channel temperature | | -55 ~ +150 | °C |
| T _{stg} | Storage temperature | | -55 ~ +150 | °C |
| — | Weight | Typical value | 1.2 | g |

ELECTRICAL CHARACTERISTICS (Tch = 25°C)

| Symbol | Parameter | Test conditions | Limits | | | Unit |
|------------|----------------------------------|--|--------|------|------|------|
| | | | Min. | Typ. | Max. | |
| V (BR) DSS | Drain-source breakdown voltage | Id = 1mA, VGS = 0V | 150 | — | — | V |
| IGSS | Gate-source leakage current | VGS = ±10V, VDS = 0V | — | — | ±0.1 | μA |
| IDSS | Drain-source leakage current | VDS = 150V, VGS = 0V | — | — | 0.1 | mA |
| VGS (th) | Gate-source threshold voltage | Id = 1mA, VDS = 10V | 0.6 | 0.9 | 1.2 | V |
| rDS (ON) | Drain-source on-state resistance | Id = 2A, VGS = 4V | — | 0.27 | 0.35 | Ω |
| rDS (ON) | Drain-source on-state resistance | Id = 2A, VGS = 2.5V | — | 0.28 | 0.37 | Ω |
| VDS (ON) | Drain-source on-state voltage | Id = 2A, VGS = 4V | — | 0.54 | 0.70 | V |
| yfs | Forward transfer admittance | Id = 2A, VDS = 5V | — | 12 | — | S |
| Ciss | Input capacitance | VDS = 10V, VGS = 0V, f = 1MHz | — | 1200 | — | pF |
| Coss | Output capacitance | | — | 100 | — | pF |
| Crss | Reverse transfer capacitance | | — | 35 | — | pF |
| td (on) | Turn-on delay time | VDD = 80V, Id = 2A, VGS = 4V, RGEN = RGS = 50Ω | — | 19 | — | ns |
| tr | Rise time | | — | 34 | — | ns |
| td (off) | Turn-off delay time | | — | 100 | — | ns |
| tf | Fall time | | — | 60 | — | ns |
| VSD | Source-drain voltage | IS = 2A, VGS = 0V | — | 1.0 | 1.5 | V |
| Rth (ch-c) | Thermal resistance | Channel to case | — | — | 4.17 | °C/W |
| trr | Reverse recovery time | IS = 5A, dis/dt = -100A/μs | — | 85 | — | ns |

PERFORMANCE CURVES

POWER DISSIPATION DERATING CURVE

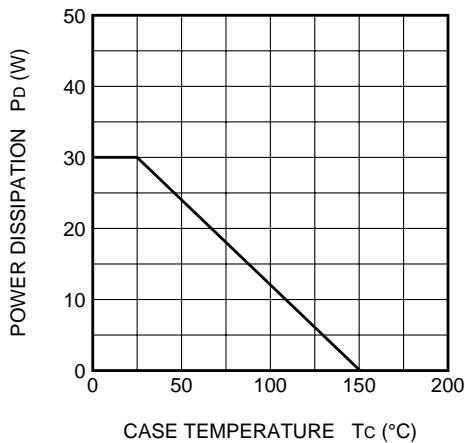

MAXIMUM SAFE OPERATING AREA

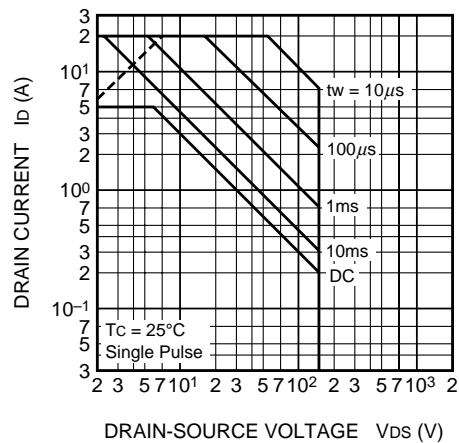

OUTPUT CHARACTERISTICS (TYPICAL)

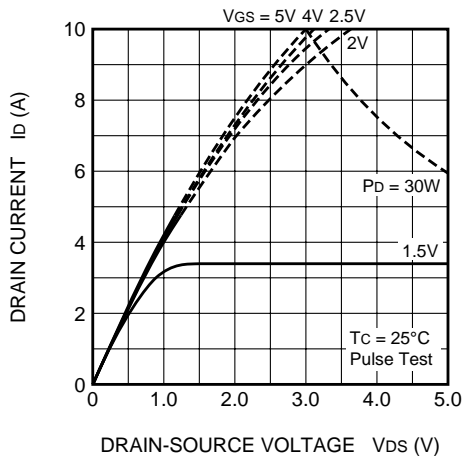

OUTPUT CHARACTERISTICS (TYPICAL)

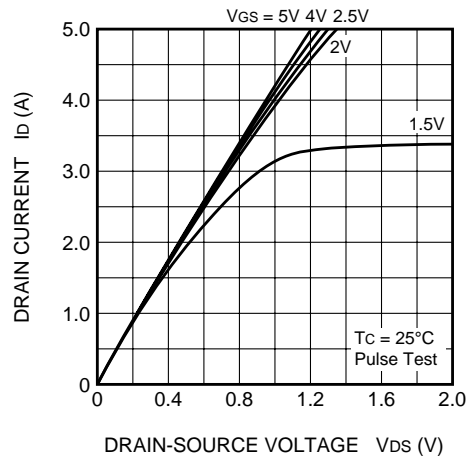

ON-STATE VOLTAGE VS. GATE-SOURCE VOLTAGE (TYPICAL)

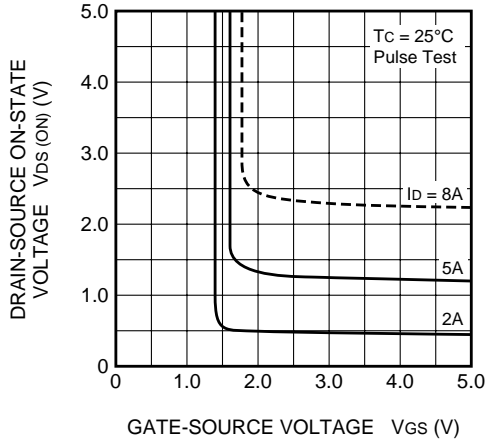

ON-STATE RESISTANCE VS. DRAIN CURRENT (TYPICAL)

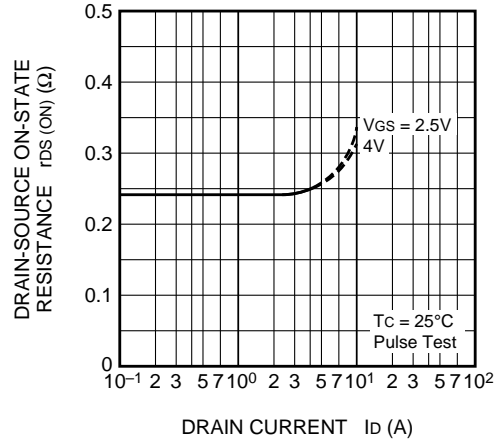

TRANSFER CHARACTERISTICS (TYPICAL)

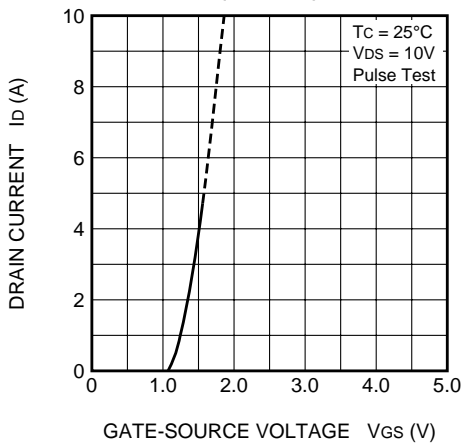

FORWARD TRANSFER ADMITTANCE VS. DRAIN CURRENT (TYPICAL)

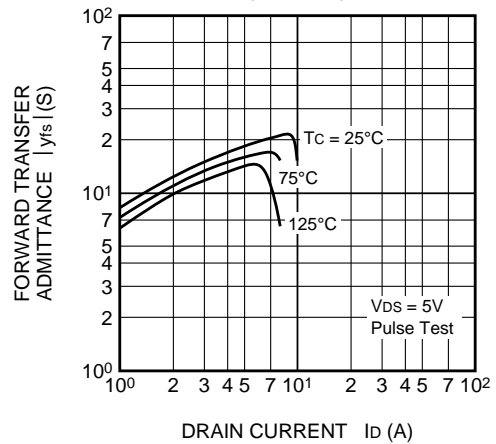

CAPACITANCE VS. DRAIN-SOURCE VOLTAGE (TYPICAL)

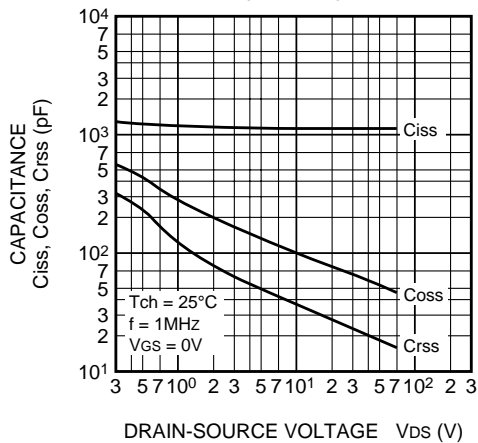

SWITCHING CHARACTERISTICS (TYPICAL)

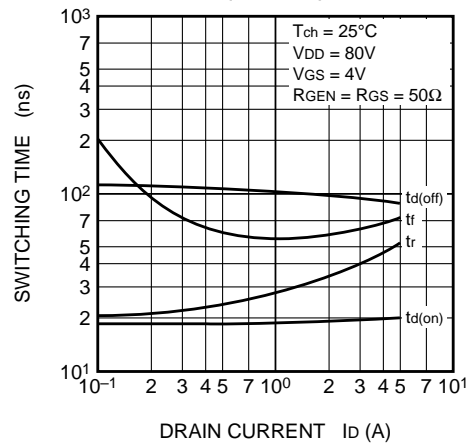

GATE-SOURCE VOLTAGE VS. GATE CHARGE (TYPICAL)

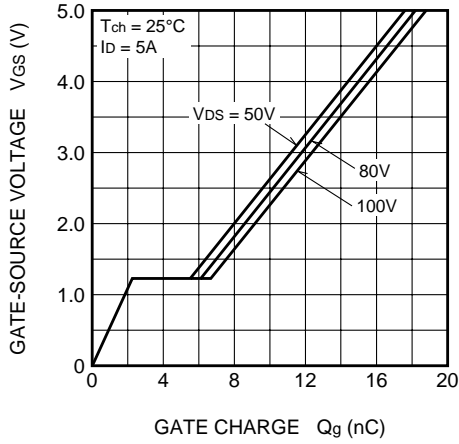

SOURCE-DRAIN DIODE FORWARD CHARACTERISTICS (TYPICAL)

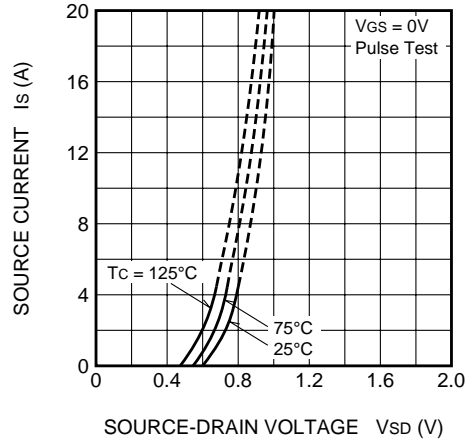

ON-STATE RESISTANCE VS. CHANNEL TEMPERATURE (TYPICAL)

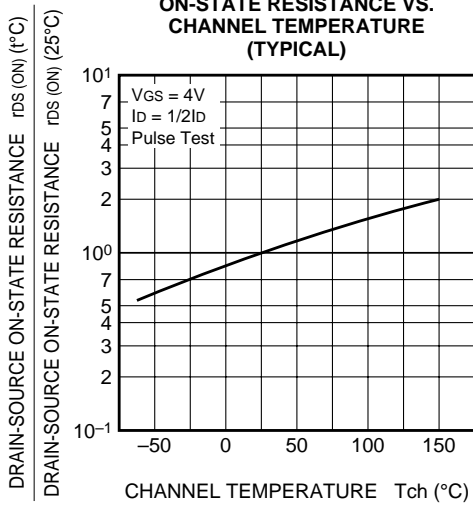

THRESHOLD VOLTAGE VS. CHANNEL TEMPERATURE (TYPICAL)

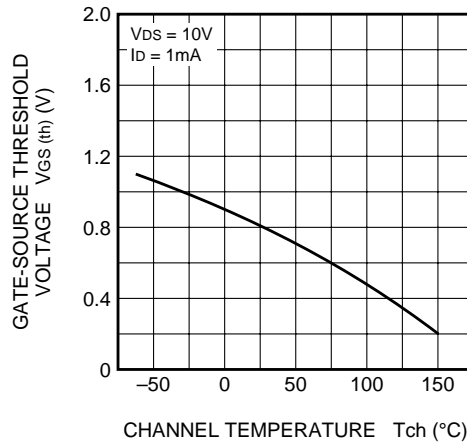

BREAKDOWN VOLTAGE VS. CHANNEL TEMPERATURE (TYPICAL)

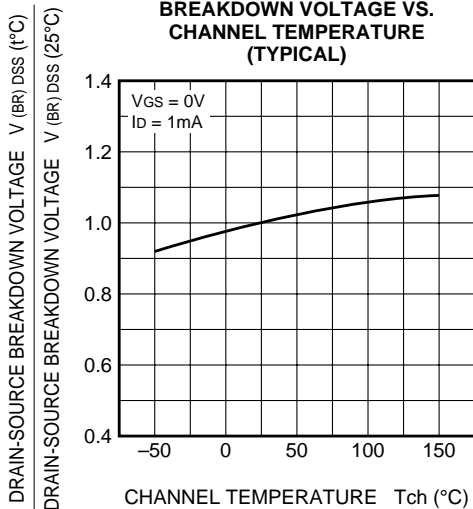

TRANSIENT THERMAL IMPEDANCE CHARACTERISTICS

