

2 mm x 5 mm Rectangular LED Lamps

Technical Data

HLMP-S100
HLMP-S20X Series
HLMP-S30X Series
HLMP-S40X Series
HLMP-S50X Series
HLMP-S600

Features

- Rectangular Light Emitting Surface
- Excellent for Flush Mounting on Panels
- Choice of Five Bright Colors
- Long Life: Solid State Reliability
- Excellent Uniformity of Light Output

Description

The HLMP-S100, -S200, -S300,

-S400, -S500, S600 are epoxy encapsulated lamps in rectangular packages which are easily stacked in arrays or used for discrete front panel indicators. Contrast and light uniformity are enhanced by a special epoxy diffusion and tinting process.

The HLMP-S100 uses double heterojunction (DH) absorbing substrate (AS) aluminum gallium arsenide (AlGaAs) LEDs to produce outstanding light output

Package Dimensions

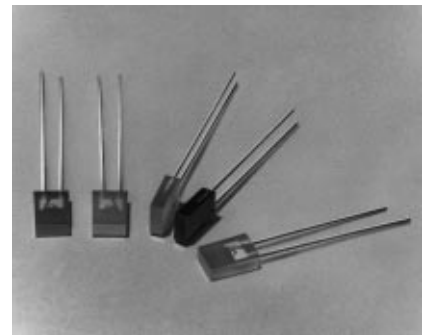
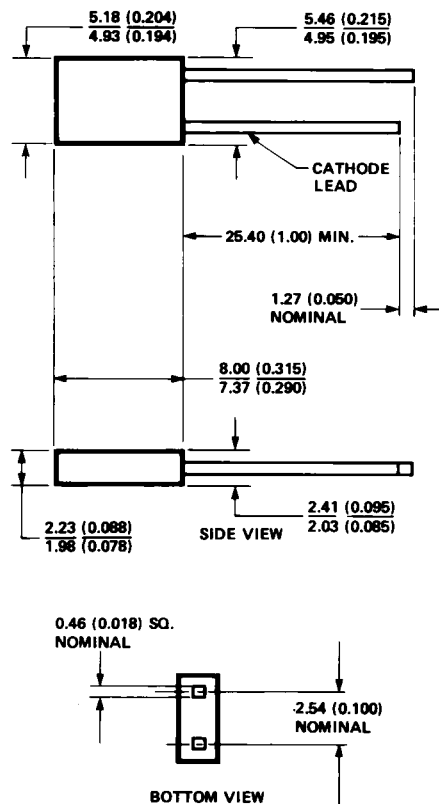

- NOTES:
1. ALL DIMENSIONS ARE IN MILLIMETERS (INCHES)
 2. AN EPOXY MENISCUS MAY EXTEND ABOUT 1 mm (0.040") DOWN THE LEADS.
 3. THERE IS A MAXIMUM 1° TAPER FROM BASE TO THE TOP OF LAMP.

Electrical/Optical Characteristics at $T_A = 25^\circ\text{C}$

Sym.	Description	Device HLMP-	Min.	Typ.	Max.	Units	Test Conditions
I_v	Luminous Intensity	AlGaAs Red S100 High Efficiency Red S200 S201 Orange S400 S401 Yellow S300 S301 Green S500 S501 Emerald Green S600 ^[4]	3.4 2.1 3.4 2.1 3.4 1.4 2.2 2.6 4.2 1.0	7.5 3.5 7.5 3.5 7.5 2.1 4.0 4.0 8.0 3.0		mcd	$I_F = 20\text{ mA}$
$2\theta_{1/2}$	Included Angle Between Half Luminous Intensity Points	All		110		Deg.	$I_F = 20\text{ mA}$ See Note 1
λ_{PEAK}	Peak Wavelength	AlGaAs Red High Efficiency Red Orange Yellow Green Emerald Green		645 635 600 583 565 558		nm	Measurement at Peak
λ_d	Dominant Wavelength	AlGaAs Red High Efficiency Red Orange Yellow Green Emerald Green		637 626 602 585 569 560		nm	See Note 2 Time const, e^{-t/τ_s}
τ_s	Speed of Response	AlGaAs Red High Efficiency Red Orange Yellow Green Emerald Green		30 90 280 90 500 3100		ns	
C	Capacitance	AlGaAs Red High Efficiency Red Orange Yellow Green Emerald Green		30 11 4 15 18 35		pF	$V_F = 0$; $f = 1\text{ MHz}$
$R\theta_{\text{J-PIN}}$	Thermal Resistance	All		260		$^\circ\text{C/W}$	Junction to Cathode Lead at Seating Plane
V_F	Forward Voltage	AlGaAs Red HER/Orange Yellow Green/Emerald Green	1.6 1.5 1.5 1.5	1.8 1.9 2.1 2.2	2.2 2.6 2.6 3.0	V	$I_F = 20\text{ mA}$
V_R	Reverse Break-down Voltage	All	5.0			V	$I_R = 100\ \mu\text{A}$

Electrical/Optical Characteristics at T_A = 25°C (cont'd)

Sym.	Description	Device HLMP-	Min.	Typ.	Max.	Units	Test Conditions
η_v	Luminous Efficacy	AlGaAs Red High Efficiency Red Orange Yellow Green Emerald Green		80 145 380 500 595 656		lumens/ watt	See Note 3

Notes:

- $\theta_{1/2}$ is the off-axis angle at which the luminous intensity is half the axial luminous intensity.
- The dominant wavelength, λ_d , is derived from the CIE chromaticity diagram and represents the single wavelength which defines the color of the device.
- Radiant intensity, I_e , in watts/steradian, may be found from the equation $I_e = I_v/\eta_v$, where I_v is the luminous intensity in candelas and η_v is the luminous efficacy in lumens/watt.
- Please refer to Application Note 1061 for information comparing standard green and emerald green light output degradation.

Absolute Maximum Ratings at T_A = 25°C

Parameter	AlGaAs Red	High Efficiency Red/Orange	Yellow	Green/ Emerald Green	Units
Peak Forward Current	300	90	60	90	mA
Average Forward Current ^[1]	20	25	20	25	mA
DC Current ^[2]	30	30	20	30	mA
Transient Forward Current ^[3] (10 μ sec Pulse)	500				mA
LED Junction Temperature	110	110	110	110	°C
Operating Temperature Range	-20 to +100	-55 to +100	-55 to +100	-20 to +100	°C
Storage Temperature Range	-55 to +100			-55 to +100	
Lead Soldering Temperature [1.6 mm (0.063 in.) below seating plane]	260°C for 5 seconds				

Notes:

- See Figure 5 to establish pulsed operating conditions.
- For AlGaAs Red, Red, Orange, and Green series derate linearly from 50°C at 0.5 mA/°C. For Yellow series derate linearly from 50°C at 0.34 mA/°C.
- The transient peak current is the maximum non-recurring peak current that can be applied to the device without damaging the LED die and wire bond. It is not recommended that the device be operated at peak currents beyond the peak forward current listed in the Absolute Maximum Ratings.

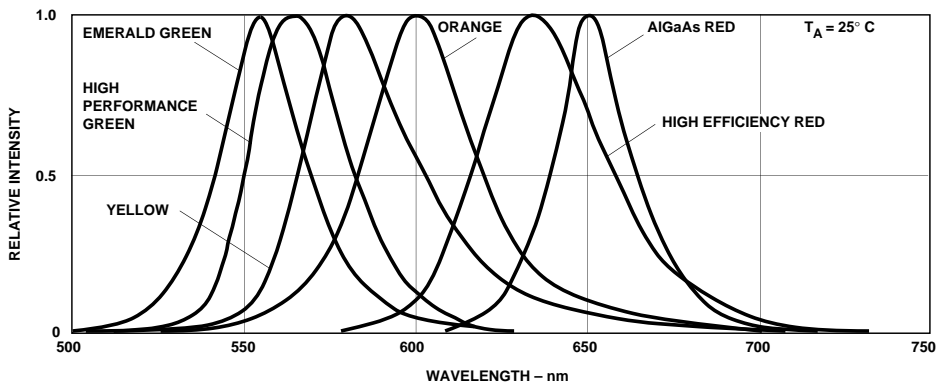

Figure 1. Relative Intensity vs. Wavelength.

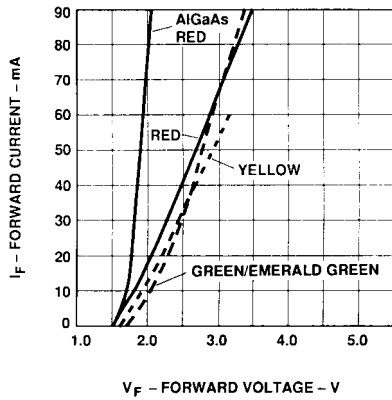

Figure 2. Forward Current vs. Forward Voltage Characteristics. V_F (300 mA) for AlGaAs Red = 2.6 Volts Typical.

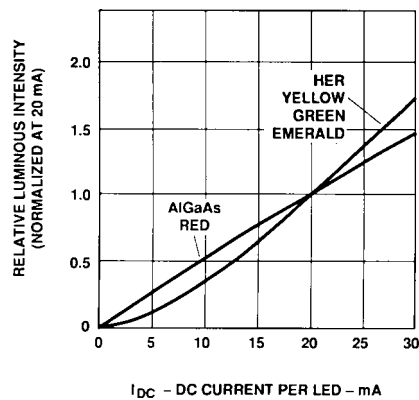

Figure 3. Relative Luminous Intensity vs. DC Forward Current.

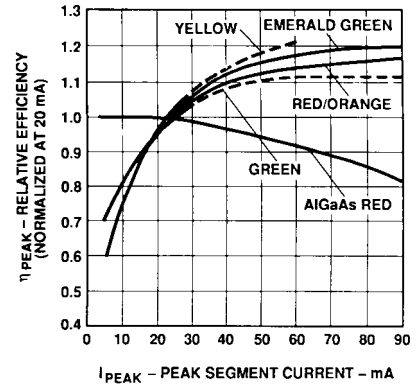

Figure 4. Relative Efficiency (Luminous Intensity per Unit Current) vs. LED Peak Current. η_V (300 mA) for AlGaAs Red = 0.7.

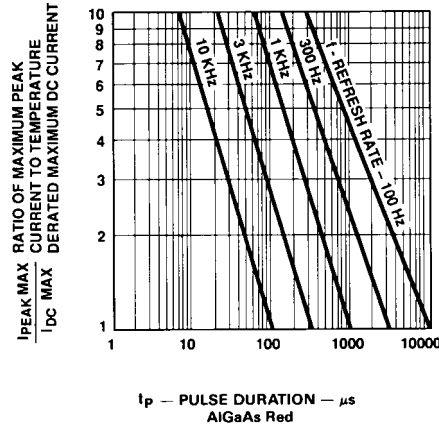
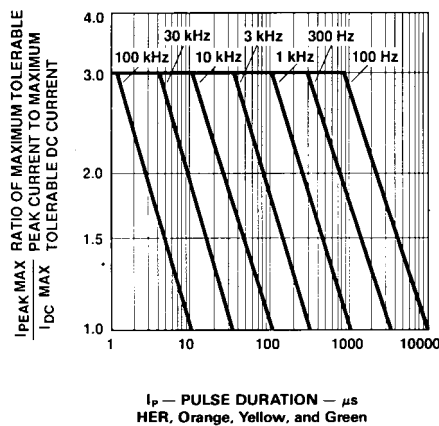

Figure 5. Maximum Tolerable Peak Current vs. Peak Duration. ($I_{PEAK MAX}$ Determined from Temperature Derated $I_{DC MAX}$).

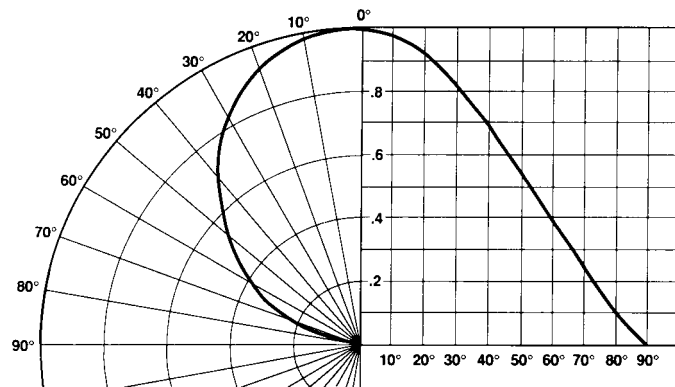

Figure 6. Relative Luminous Intensity vs. Angular Displacement.