

HEADPHONE STEREO DRIVER (1.5V USE)
BUILT-IN BOOST SYSTEM POWER AMP.

The KIA8157AFN is a headphone stereo driver IC designed for Low Voltage Operation (1.5V) which is suitable for stereo headphone radio and radio cassette recorder equipment.

FEATURES

- Built-in low boost amp.
- Condenser-less for output coupling.
- Built-in ripple filter.
- $G_V=24\text{dB}$ (typ.)
- Built-in power ON/OFF switch.
- Built-in the muting function.
- Excellent ripple rejection.
- Low noise.
- Operating supply voltage range. ($T_a=25^\circ\text{C}$)
: $V_{CC(\text{opr})}=0.9\sim 2.2\text{V}$.

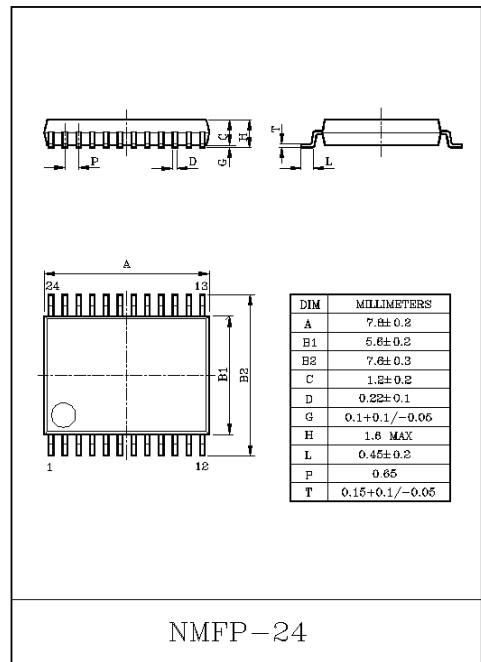

MAXIMUM RATINGS ($T_a=25^\circ\text{C}$)

CHARACTERISTIC	SYMBOL	RATING	UNIT
Supply Voltage	V_{CC}	4.5	V
Power Output Current	I_o (peak)	100	mA
Power Dissipation	P_D (Note)	500	mW
Operating Temperature	T_{opr}	-25~75	$^\circ\text{C}$
Storage Temperature	T_{stg}	-55~150	$^\circ\text{C}$

Note) Derated above $T_a=25^\circ\text{C}$ in the proportion $4\text{mW}/^\circ\text{C}$

KIA8157AFN

ELECTRICAL CHARACTERISTICS

(Unless otherwise specified, $V_{CC}=1.2V$, $R_L=16\Omega$, $R_g=600\Omega$, $f=1kHz$, $T_a=25^\circ C$)

SW1 : a, SW2 : a, SW3 : b, SW 4 : a, SW5 : a, SW6 : a, SW7 : ON, SW8 : OPEN)

CHARACTERISTIC		SYMBOL	TEST CIRCUIT	TEST CONDITION	MIN.	TYP.	MAX.	UNIT
Quiescent Current		I_{CC1}	1	Power OFF, SW1 : b, SW2 : b	-	0.1	5	μA
		I_{CC2}		Mute, SW2 : b	-	2.4	4.0	mA
		I_{CC3}		$V_{IN}=0$	-	8	11.5	
Power	Voltage Gain	G_{V1}	2	$V_{O(A)}=V_{O(B)}=-20dBm$	22	24	26	dB
	Channel Balance	C_{B1}			-	0	1.5	
	Output Power 1	P_{O1}	2	$V_{CC}=1.5V$, THD(A)=THD(B)=10%	5	9	-	mW
	Output Power 2	P_{O2}		$V_{CC}=1.5V$ THD(A)=THD(B)=10% $V_{IN(A)}=V_{IN(B)}=-V_{IN(C)}$ $f=100Hz$, *BTL Operation SW3 : a, SW5 : b	8	14	-	
	Total Harmonic Distortion	THD	2	$P_{O(A)}=P_{O(B)}=1mW$	-	0.6	1	%
	Output Noise Voltage	V_{NO}	2	BPF=20Hz~20kHz, SW4 : b	-	25	40	μV_{rms}
	Cross Talk	CT	2	$V_O=-20dBm$, SW4 : b	35	42	-	dB
	Ripple Rejection Ratio	RR1	2	$V_{CC}=1.0V$, $f_R=100Hz$, $V_R=-30dBm$, SW7 : OPEN	45	55	-	
	Muting Attenuation	ATT1	2	$V_O=-20dBm$, SW2 : a→b	-	73	-	
Boost	ADD Amp Voltage Gain	G_{V2}	2	$V_{IN(A)}=V_{IN(B)}$, $R_L=12k\Omega$, $V_{O(ADD)}=-20dBm$, SW3 : a/b	15	17.5	20	dB
	ADD Amp Maximum Output Voltage	V_{OM2}	2	$V_{IN(A)}=V_{IN(B)}$, $R_L=12k\Omega$, THD(ADD)=1%, SW3 : a/b	80	130	-	mV_{rms}
	BST Amp Voltage Gain	G_{V3}	2	$V_O=-35dBm$, $R_L=16k\Omega$, SW6 : b	14	16.5	19	dB
	BST Amp Maximum Output Voltage	V_{OM3}	2	THD(BST)=3%, $R_L=12k\Omega$, SW6 : b	55	90	130	mV_{rms}
	BST Amp Muting Attenuation	ATT3	2	$V_O=-30dBm$, SW3 : a→b SW6 : b	-	73	-	dB

KIA8157AFN

CHARACTERISTIC	SYMBOL	TEST CIRCUIT	TEST CONDITION	MIN.	TYP.	MAX.	UNIT
Filter Output Voltage	$V_{RF(OUT)}$	2	$V_{CC}=1V, I_{RF}=20mA$	0.9	0.93	-	V
Ripple Rejection Ratio	RR4	2	$V_{CC}=1V, I_{RF}=20mA,$ $f_R=100Hz, V_R=-35dBm$ SW7 : OPEN	35	43	-	dB
Equalizer ON Resistor	R_{ON}	1	$I_{BQ}=100\mu A, SW3 : a,$ SW8 : ON	-	60	-	Ω
Power ON Correction Current	I_{11}	1	$V_{CC}=0.9V, V_4 \geq 0.5V,$ SW1 : c, SW2 : b	5	-	-	μA
Power OFF Correction Voltage	V_{11}	1	$V_{CC}=0.9V, V_4 \leq 0.2V,$ SW1 : d, SW2 : b	0	-	0.3	V
Mute OFF Correction Current	I_{10}	1	$V_{CC}=0.9V, I_{CC3} \geq 4.5mA,$ SW2 : c	5	-	-	μA
Mute ON Correction Voltage	V_{10}	1	$V_{CC}=0.9V, I_{CC3} \geq 3.5mA,$ SW2 : d	0	-	0.3	V
BST OFF Correction Current	I_1	1	$V_{CC}=0.9V, I_{BQ}=100\mu A,$ $V_2 \geq 0.7V, SW3 : c,$ SW8 : ON	5	-	-	μA
BST ON Correction Voltage	V_1	1	$V_{CC}=0.9V, I_{BQ}=100\mu A,$ $V_2 \geq 0.2V, SW3 : d,$ SW8 : ON	0.6	-	0.9	V

KIA8157AFN

BLOCK DIAGRAM

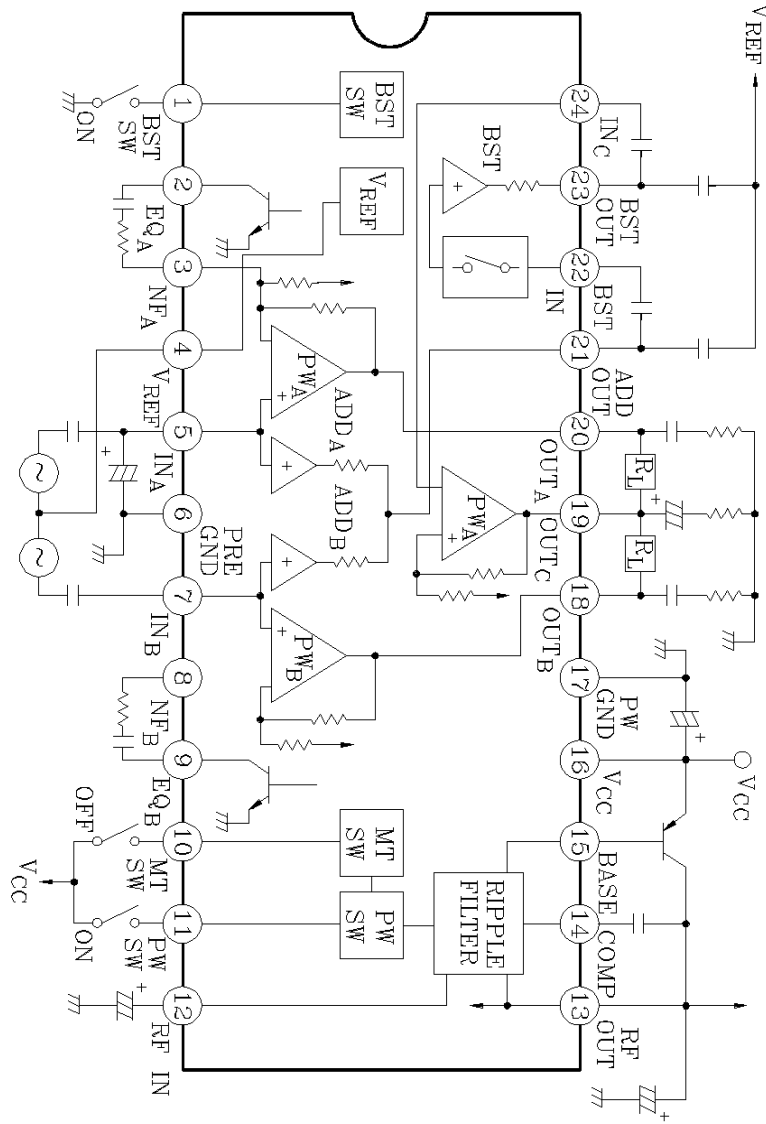

KIA8157AFN

TEST CIRCUIT 1

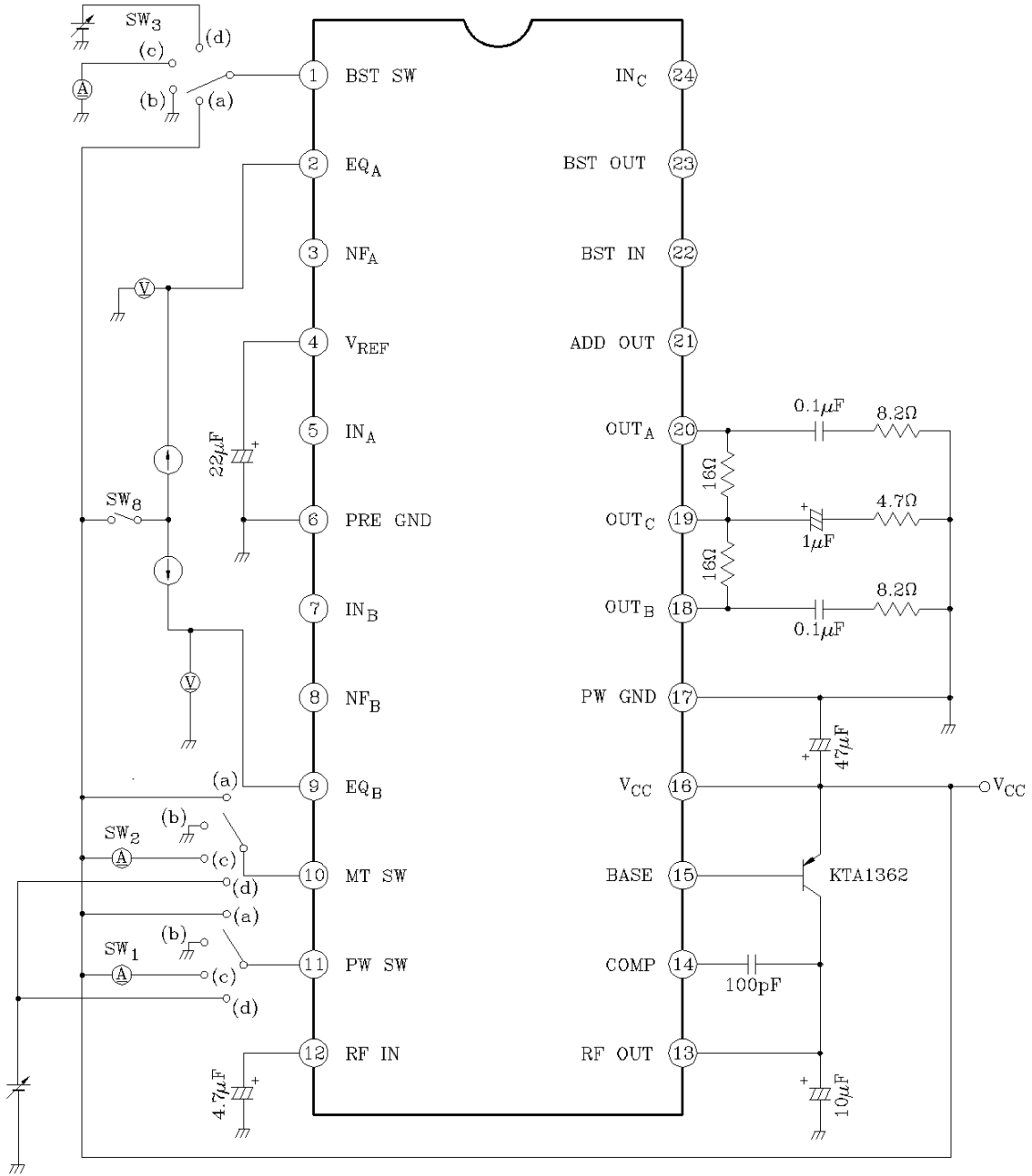

KIA8157AFN

TEST CIRCUIT 2

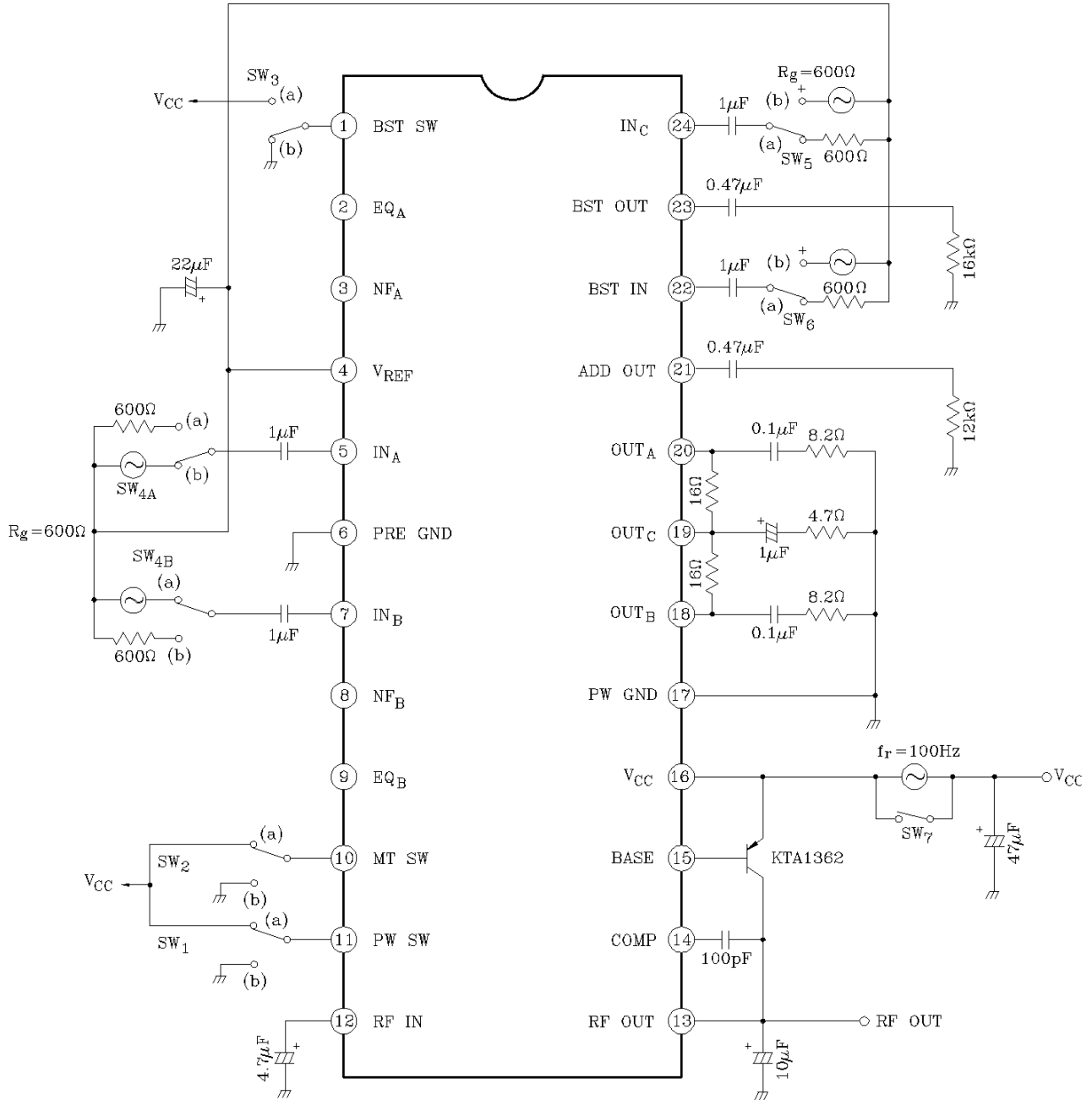

KIA8157AFN

EXPLANATION OF TERMINALS (Terminal voltage $V_{IN}=0$, $V_{CC}=1.2V$, $T_a=25^\circ C$)

PIN NO.	TERMINAL NAME	CONTENTS	INTERNAL EQUIVALENT CIRCUIT	DC VOLTAGE (V)
1	BST SW	Boost Amp ON/OFF switch (Equalizer switch circuit gearing) $\left[\begin{array}{l} V_{CC}/OPEN : ON \\ GND : OFF \end{array} \right.$		-
2	EQ _A	Equalizer switch (BST SW control) ON Resistor : 60Ω (Typ.)		-
9	EQ _B			-
4	V _{REF}	Reference Circuit		0.75
5	IN _A	Power Amp. Input (Adder Amp. Input Common)		0.75
7	IN _B			0.75
3	NFA	Power Amp. NF Terminal.		0.6
8	NFB			0.6
20	OUT _A	Power Amp. Output		0
18	OUT _B			0
6	PRE GND	-	-	0
10	MT SW	Mute Switch $\left[\begin{array}{l} V_{CC} : \text{Mute OFF} \\ GND/OPEN : \text{Mute ON} \end{array} \right.$		-
11	PW SW	Power ON/OFF Switch $\left[\begin{array}{l} V_{CC} : \text{IC operating} \\ GND/OPEN : \text{IC OFF} \end{array} \right.$		-
12	RF IN	Ripple Filter Circuit Filter Terminal.		1.2

KIA8157AFN

PIN NO.	TERMINAL NAME	CONTENTS	INTERNAL EQUIVALENT CIRCUIT	DC VOLTAGE (V)
13	RF OUT	Ripple Filter Output : V_{REF} Circuit Adder Amp., Supply Voltage for Boost Amp.		1.13
14	COMP	Ripple Filter Oscillator		0.7
15	BASE	Base Bias Terminal of Transistor for Ripple Filter		0.5
16	V_{CC}	-	-	1.2
17	PW GND	-	-	0
19	OUT _c	Center Amp. Output		0.6
24	IN _c	Center Amp. Input		0.75
21	ADD OUT	Adder Amp. Output The Common of Adder Amp. Input and Power Amp.		0.6
22	BST IN	Boost Amp. Output		0.75
23	BST OUT	Boost Amp. Output (BST SW Control) BST ON : BST Amp. Operating BST OFF : BST Amp. OFF (Cut off BST Input Signal)		0.6

KIA8157AFN

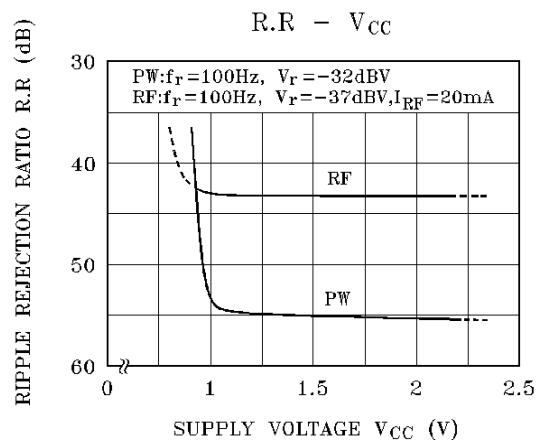
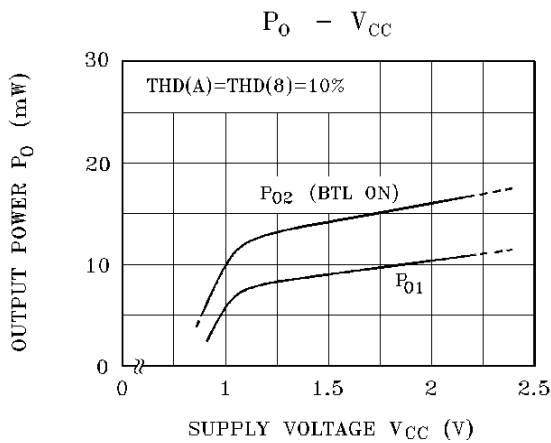
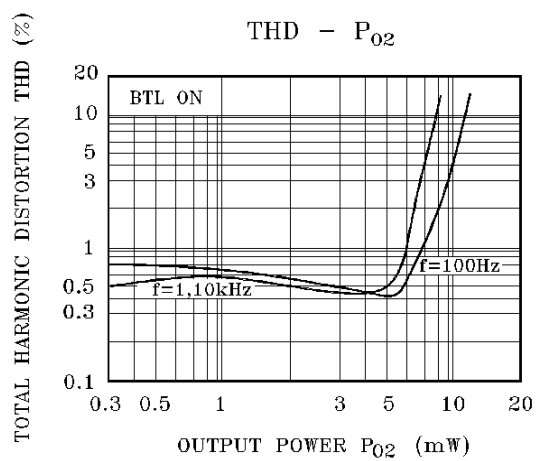
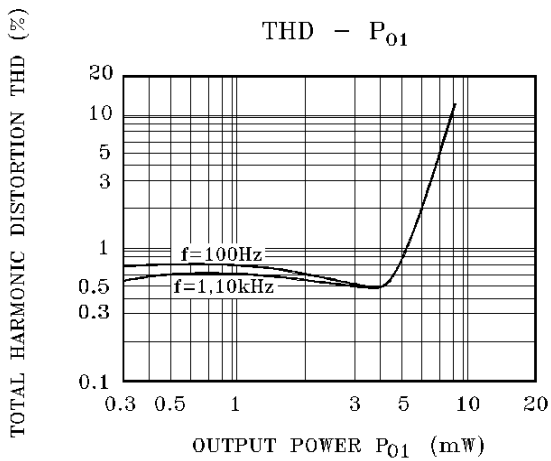
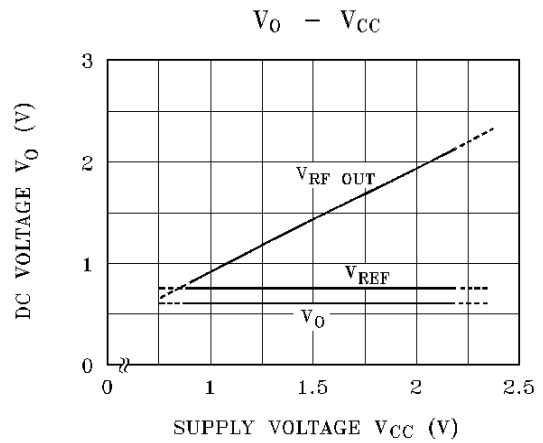
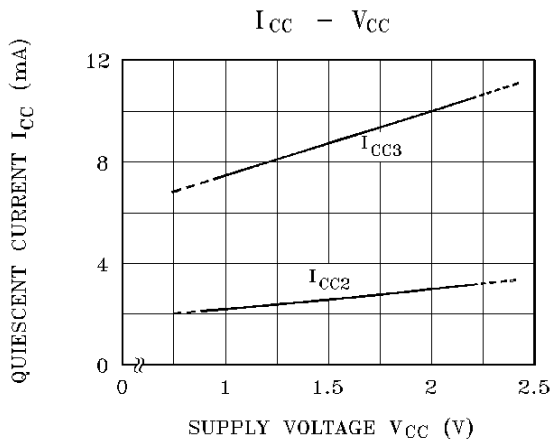

KIA8157AFN

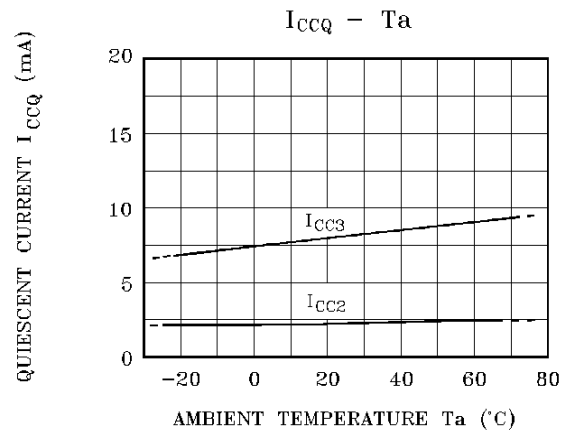
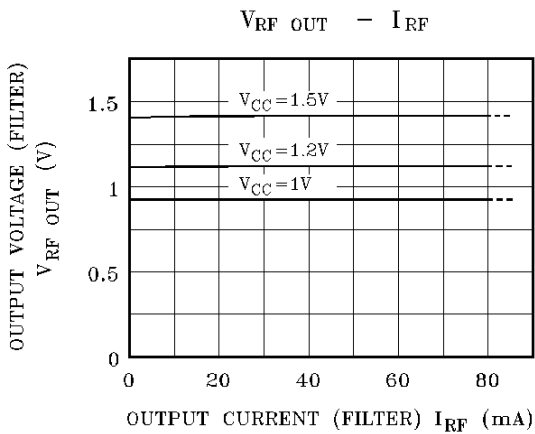
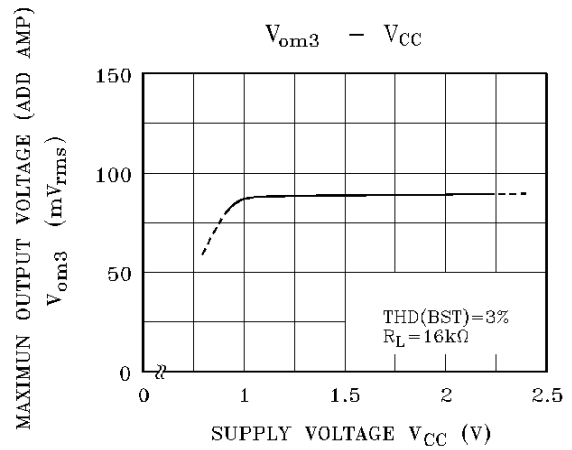
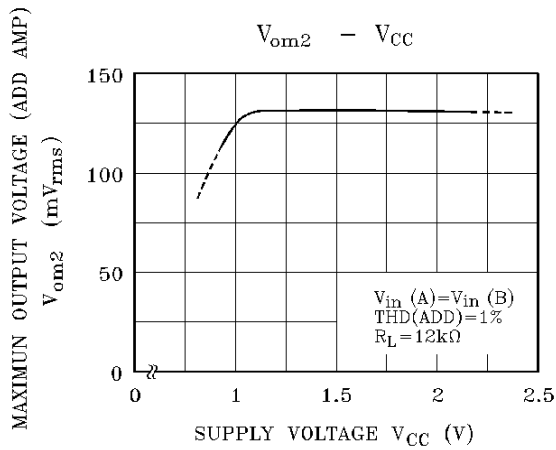
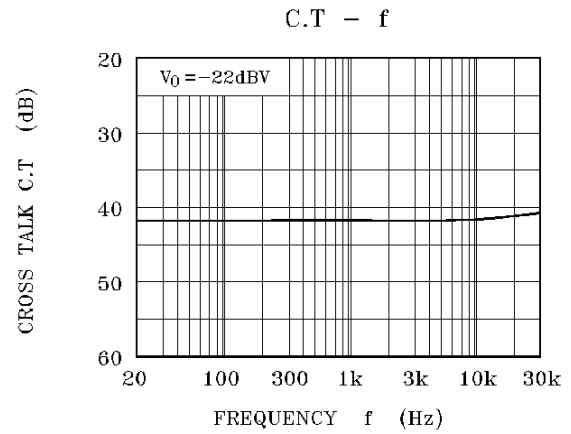
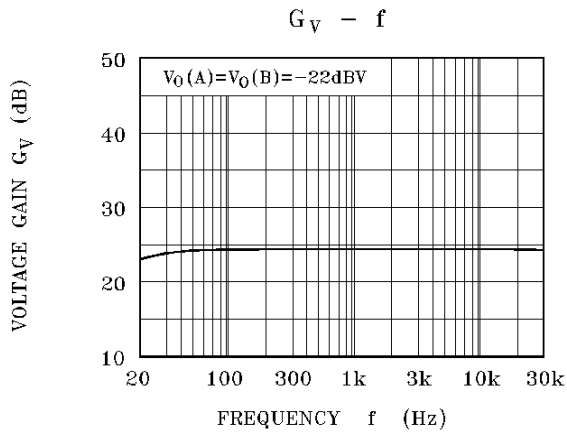

KIA8157AFN

