

STANDARD RECOVERY DIODES

Hockey Puk Version

Features

- Wide current range
- High voltage ratings up to 3200V
- High surge current capabilities
- Diffused junction
- Hockey Puk version
- Case style B-43

Typical Applications

- Converters
- Power supplies
- Machine tool controls
- High power drives
- Medium traction applications

1400A

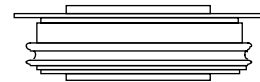

case style B-43

Major Ratings and Characteristics

Parameters	SD1100C..C		Units	
	04 to 20	25 to 32		
$I_{F(AV)}$	1400	1100	A	
@ T_{hs}	55	55	°C	
$I_{F(RMS)}$	2500	2000	A	
@ T_{hs}	25	25	°C	
I_{FSM}	@ 50Hz	13000	10500	A
	@ 60Hz	13600	11000	A
I^2t	@ 50Hz	846	551	KA ² s
	@ 60Hz	772	503	KA ² s
V_{RRM}	range	400 to 2000	2500 to 3200	V
T_J	range	- 40 to 180	- 40 to 150	°C

SD1100C..C Series

Bulletin I2072 rev.D 04/00

International
 Rectifier

ELECTRICAL SPECIFICATIONS

Voltage Ratings

Type number	Voltage Code	V_{RRM} , maximum repetitive peak reverse voltage V	V_{RSM} , maximum non-repetitive peak rev. voltage V	I_{RRM} max. @ $T_J = T_J$ max. mA
SD1100C..C	04	400	500	35
	08	800	900	
	12	1200	1300	
	16	1600	1700	
	20	2000	2100	
	25	2500	2600	
	30	3000	3100	
	32	3200	3300	

Forward Conduction

Parameter	SD1100C..C		Units	Conditions		
	04 to 20	25 to 32				
$I_{F(AV)}$ Max. average forward current @ Heatsink temperature	1400(795)	1100(550)	A	180° conduction, half sine wave		
	55(85)	55(85)	°C	Double side (single side) cooled		
$I_{F(RMS)}$ Max. RMS forward current	2500	2000	A	@ 25°C heatsink temperature double side cooled		
I_{FSM} Max. peak, one-cycle forward, non-repetitive surge current	13000	10500	A	t = 10ms	No voltage	Sinusoidal halfwave, Initial $T_J = T_J$ max.
	13600	11000		t = 8.3ms	reapplied	
	10930	8830		t = 10ms	100% V_{RRM}	
	11450	9250		t = 8.3ms	reapplied	
I^2t Maximum I^2t for fusing	846	551	KA ² s	t = 10ms	No voltage	
	772	503		t = 8.3ms	reapplied	
	598	390		t = 10ms	100% V_{RRM}	
	546	356		t = 8.3ms	reapplied	
$I^2\sqrt{t}$ Maximum $I^2\sqrt{t}$ for fusing	8460	5510	KA ² √s	t = 0.1 to 10ms, no voltage reapplied		
$V_{F(TO)1}$ Low level value of threshold voltage	0.78	0.84	V	$(16.7\% \times \pi \times I_{F(AV)} < I < \pi \times I_{F(AV)})$, $T_J = T_J$ max.		
$V_{F(TO)2}$ High level value of threshold voltage	0.94	0.88		$(I > \pi \times I_{F(AV)})$, $T_J = T_J$ max.		
r_{f1} Low level value of forward slope resistance	0.35	0.40	mΩ	$(16.7\% \times \pi \times I_{F(AV)} < I < \pi \times I_{F(AV)})$, $T_J = T_J$ max.		
r_{f2} High level value of forward slope resistance	0.26	0.38		$(I > \pi \times I_{F(AV)})$, $T_J = T_J$ max.		
V_{FM} Max. forward voltage drop	1.31	1.44	V	$I_{pk} = 1500A$, $T_J = T_J$ max, $t_p = 10ms$ sinusoidal wave		

Thermal and Mechanical Specifications

Parameter	SD1100C..C		Units	Conditions
	04 to 20	25 to 32		
T _J Max. junction operating temperature range	-40 to 180	-40 to 150	°C	
T _{stg} Max. storage temperature range	-55 to 200	-55 to 200		
R _{thJ-hs} Max. thermal resistance, junction to heatsink	0.076 0.038		K/W	DC operation single side cooled DC operation double side cooled
F Mounting force, ± 10%	9800 (1000)		N (Kg)	
wt Approximate weight	83		g	
Case style	B - 43			See Outline Table

ΔR_{thJ-hs} Conduction

(The following table shows the increment of thermal resistance R_{thJ-hs} when devices operate at different conduction angles than DC)

Conduction angle	Sinusoidal conduction		Rectangular conduction		Units	Conditions
	Single Side	Double Side	Single Side	Double Side		
180°	0.007	0.007	0.005	0.005	K/W	T _J = T _J max.
120°	0.008	0.008	0.008	0.008		
90°	0.010	0.010	0.011	0.011		
60°	0.015	0.015	0.016	0.016		
30°	0.026	0.026	0.026	0.026		

Ordering Information Table

Device Code

SD	110	0	C	32	C
①	②	③	④	⑤	⑥

- 1** - Diode
- 2** - Essential part number
- 3** - 0 = Standard recovery
- 4** - C = Ceramic Puk
- 5** - Voltage code: Code x 100 = V_{RRM} (See Voltage Ratings table)
- 6** - C = Puk Case B - 43

SD1100C..C Series

Bulletin I2072 rev.D 04/00

International
IRF Rectifier

Outline Table

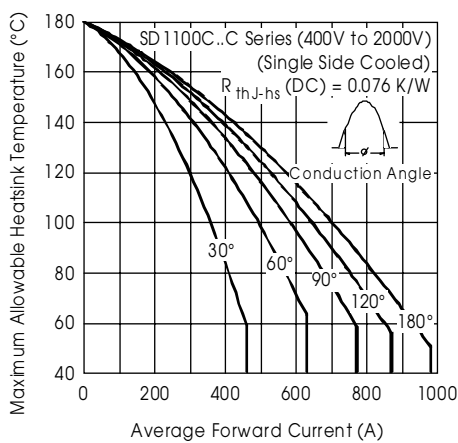
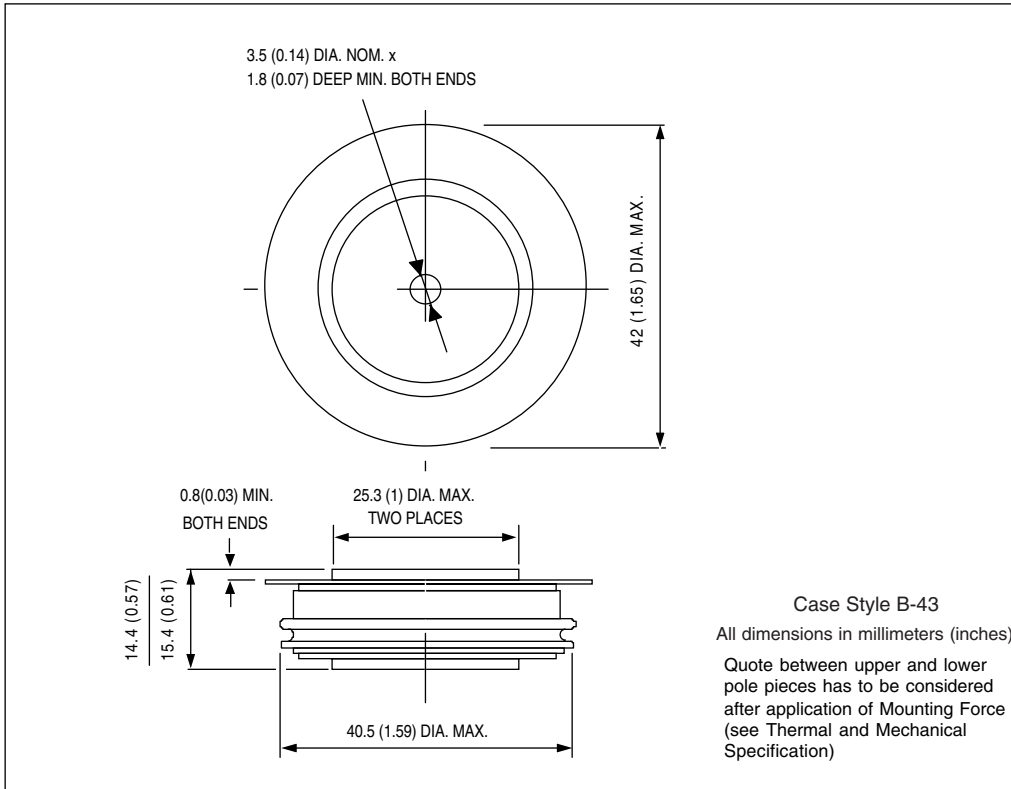

Fig. 1 - Current Ratings Characteristics

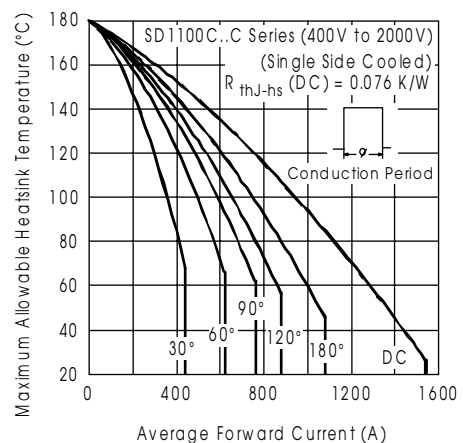

Fig. 2 - Current Ratings Characteristics

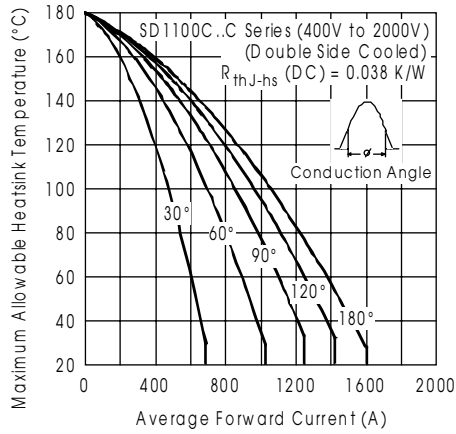

Fig. 3 - Current Ratings Characteristics

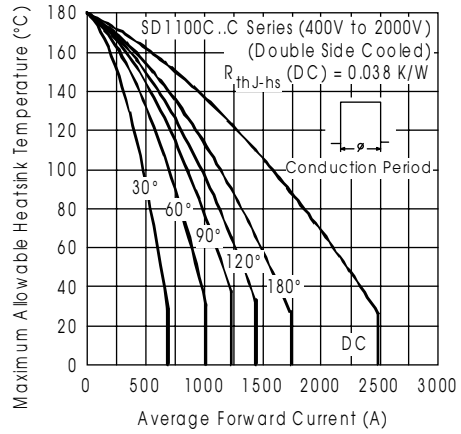

Fig. 4 - Current Ratings Characteristics

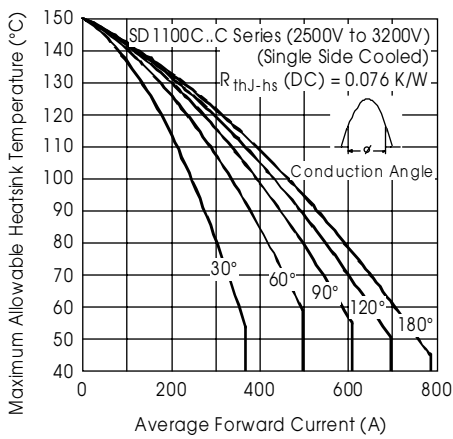

Fig. 5 - Current Ratings Characteristics

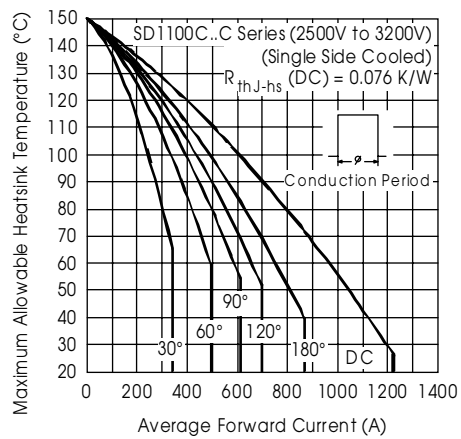

Fig. 6 - Current Ratings Characteristics

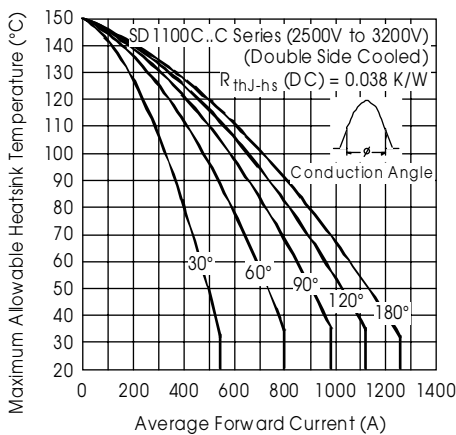

Fig. 7 - Current Ratings Characteristics

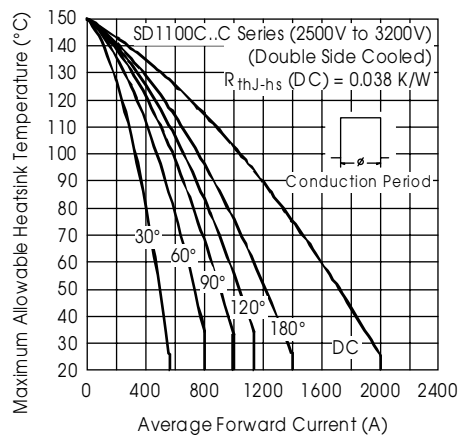

Fig. 8 - Current Ratings Characteristics

SD1100C..C Series

Bulletin I2072 rev. D 04/00

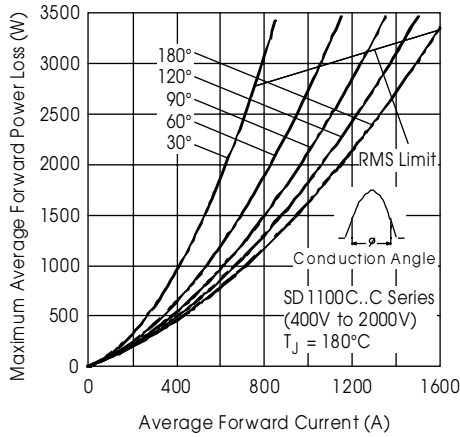

Fig. 9 - Forward Power Loss Characteristics

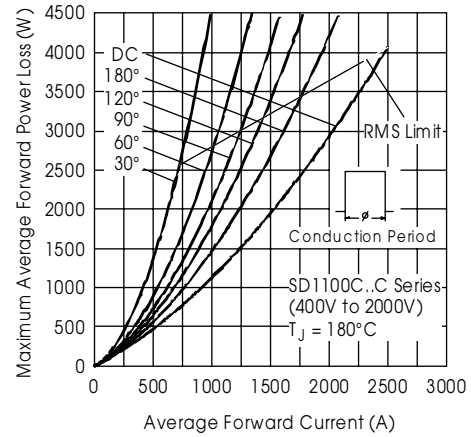

Fig. 10 - Forward Power Loss Characteristics

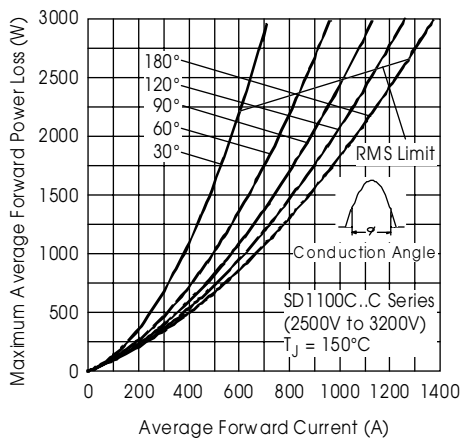

Fig. 11 - Forward Power Loss Characteristics

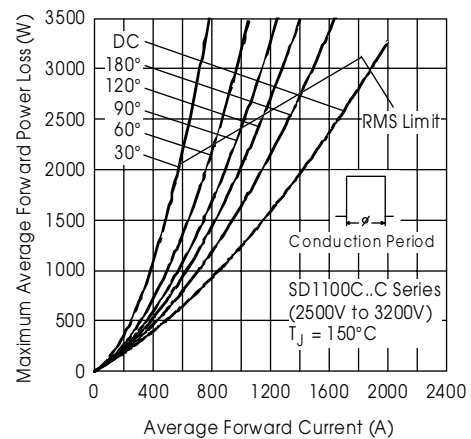

Fig. 12 - Forward Power Loss Characteristics

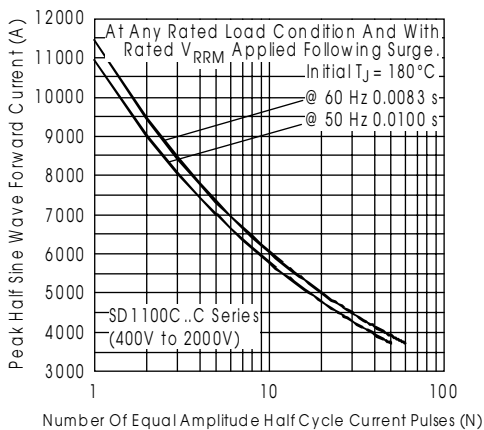

Fig. 13 - Maximum Non-Repetitive Surge Current Single and Double Side Cooled

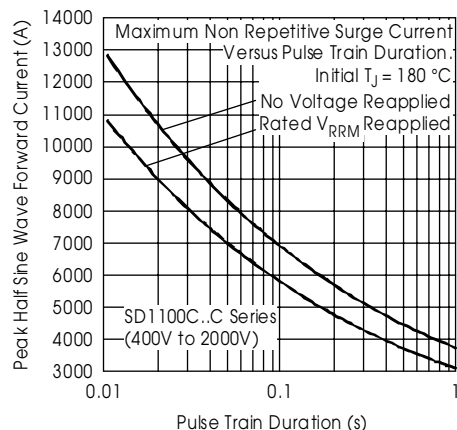

Fig. 14 - Maximum Non-Repetitive Surge Current Single and Double Side Cooled

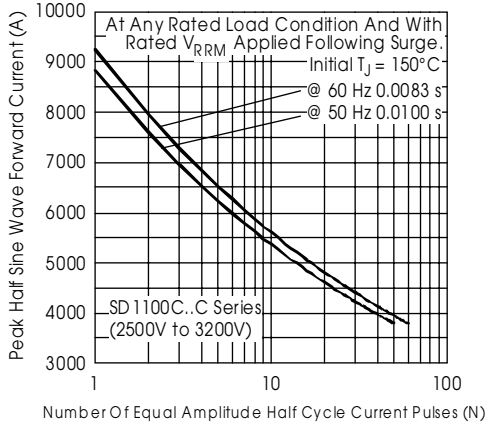

Fig. 15 - Maximum Non-Repetitive Surge Current Single and Double Side Cooled

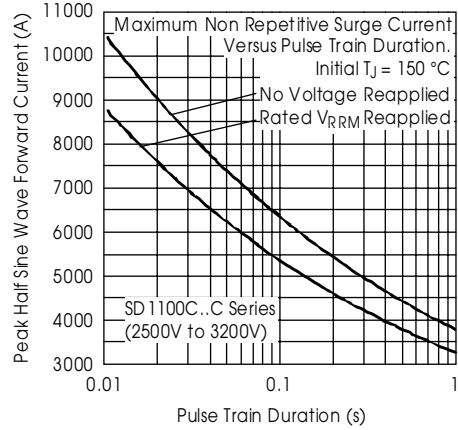

Fig. 16 - Maximum Non-Repetitive Surge Current Single and Double Side Cooled

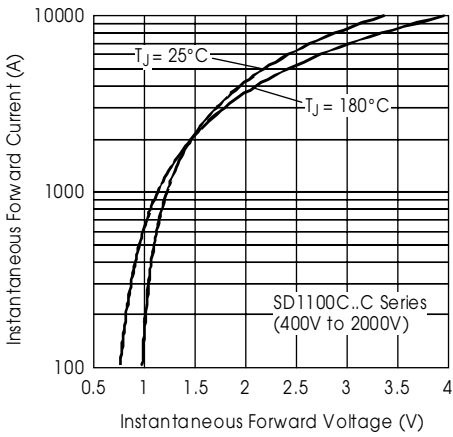

Fig. 17 - Forward Voltage Drop Characteristics

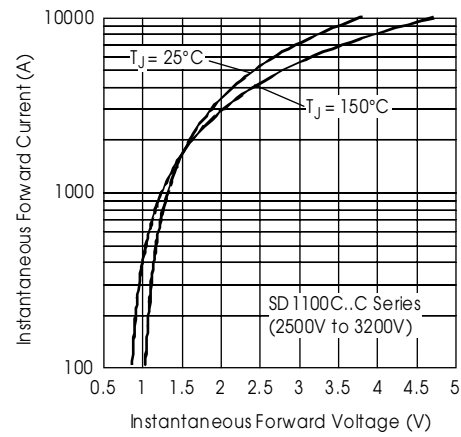

Fig. 18 - Forward Voltage Drop Characteristics

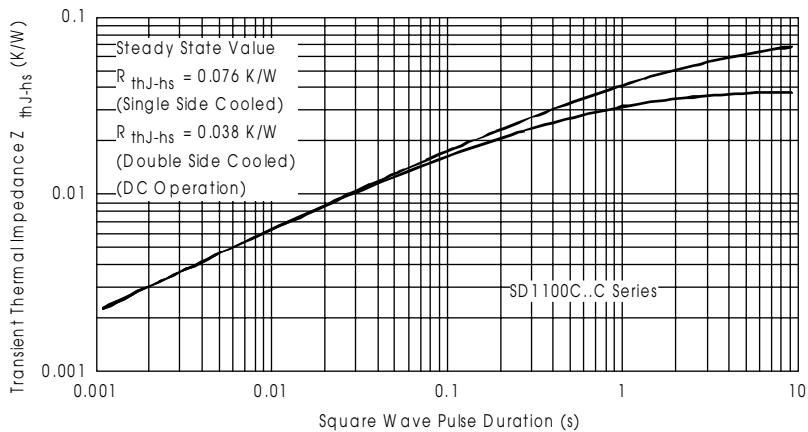

Fig. 19 - Thermal Impedance Z_{thJC} Characteristics