

2SB884/2SD1194

Continued from preceding page.

| Parameter | Symbol | Conditions | Ratings | | | Unit |
|--|---------------|------------------------------|---------|-------|-----|---------|
| | | | min | typ | max | |
| Collector-to-Base Breakdown Voltage | $V_{(BR)CBO}$ | $I_C=(-)5mA, I_E=0$ | (-)110 | | | V |
| Collector-to-Emitter Breakdown Voltage | $V_{(BR)CEO}$ | $I_C=(-)50mA, R_{BE}=\infty$ | (-)100 | | | V |
| Turn-ON Time | t_{on} | See specified Test Circuit | | (0.8) | | μs |
| | | | | 0.7 | | μs |
| Storage Time | t_{stg} | See specified Test Circuit | | (2.4) | | μs |
| | | | | 5.0 | | μs |
| Fall Time | t_f | See specified Test Circuit | | (1.2) | | μs |
| | | | | 1.2 | | μs |

Switching Time Test Circuit

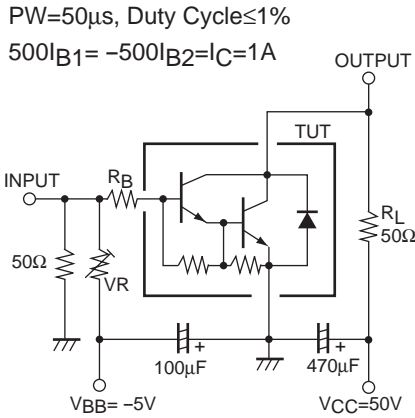

(For PNP, the polarity is reversed.)

Electrical Connection

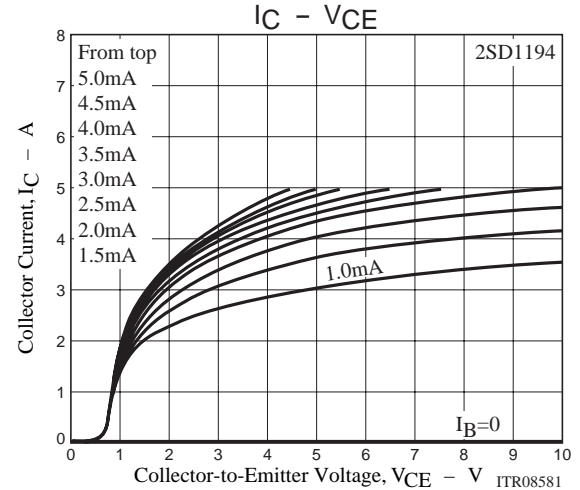
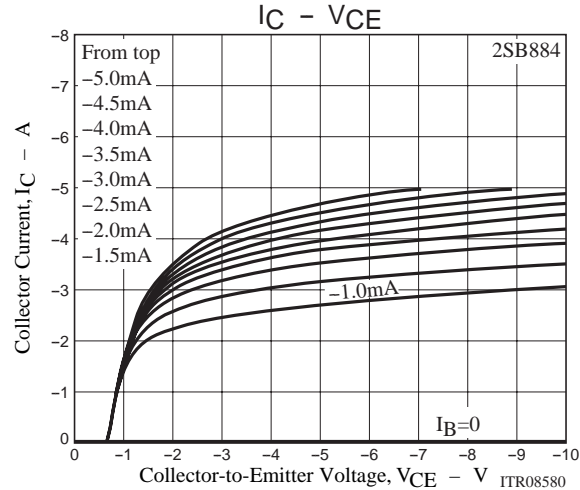
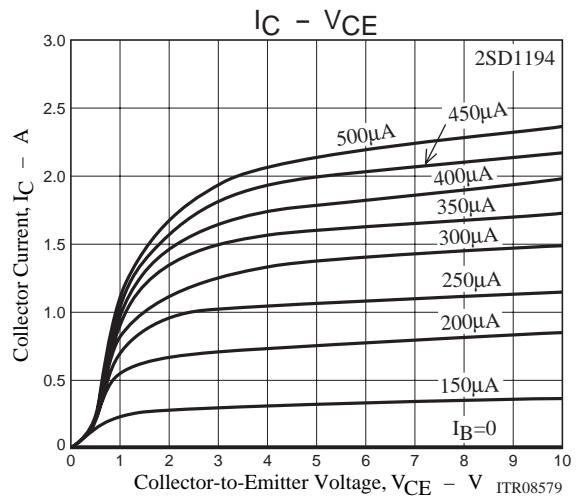
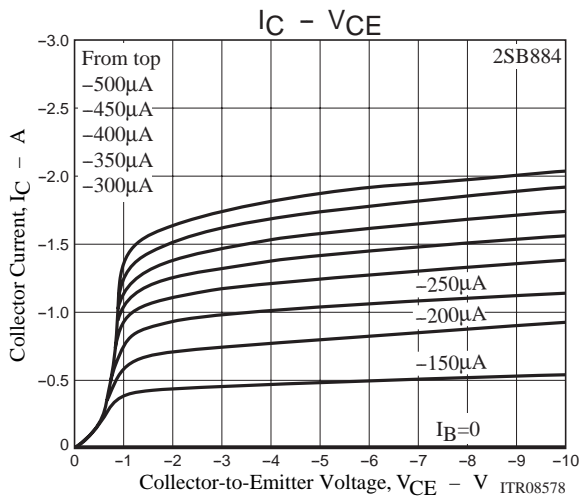
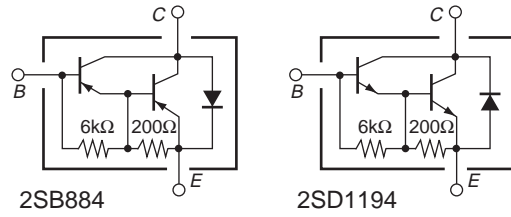

2SB884/2SD1194

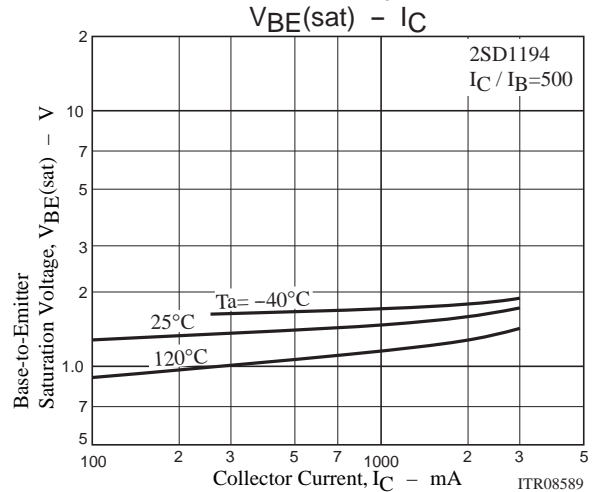
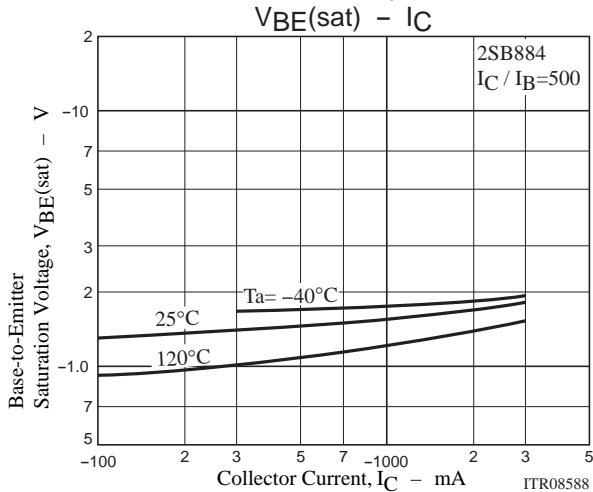
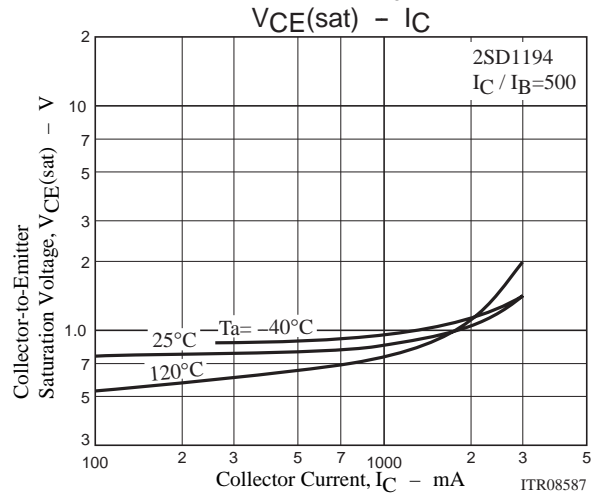
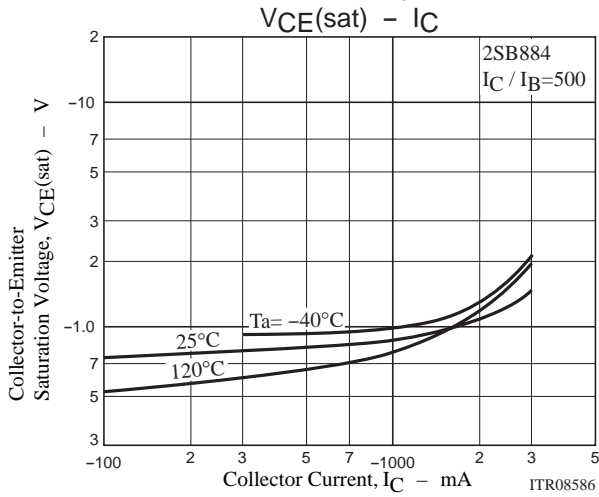
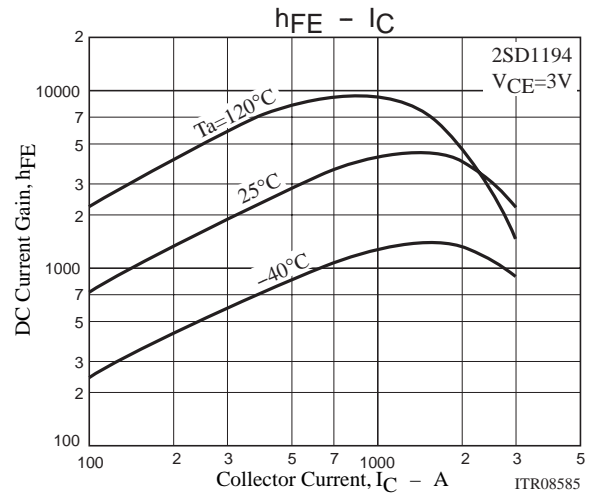
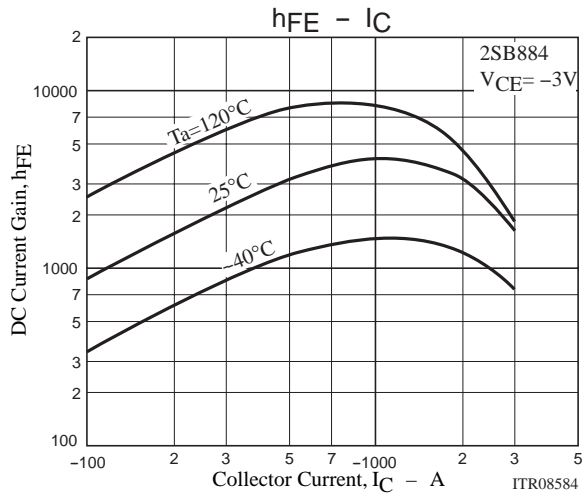
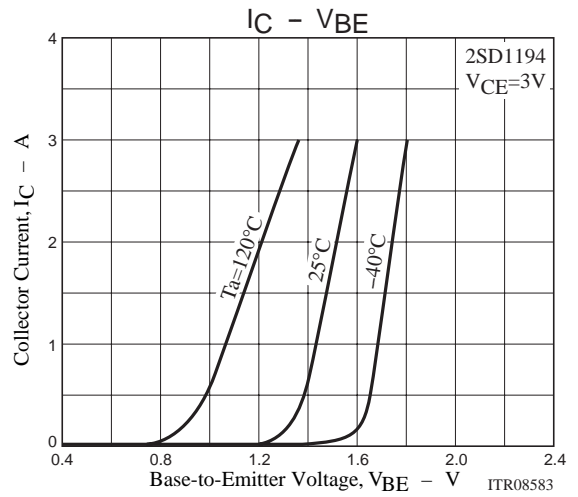
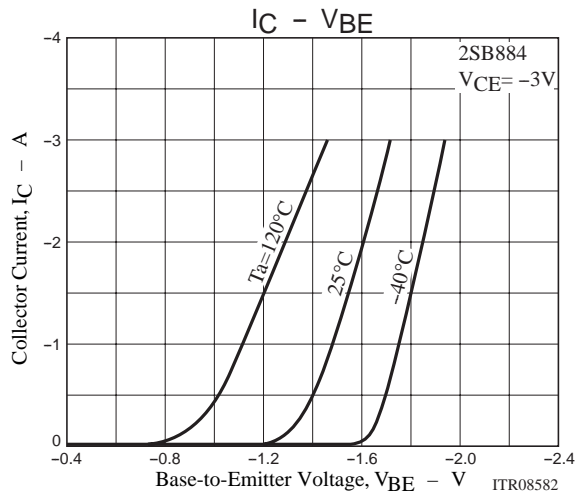

2SB884/2SD1194

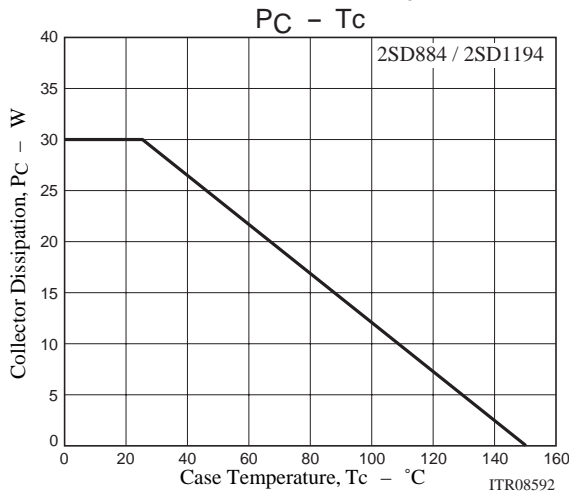
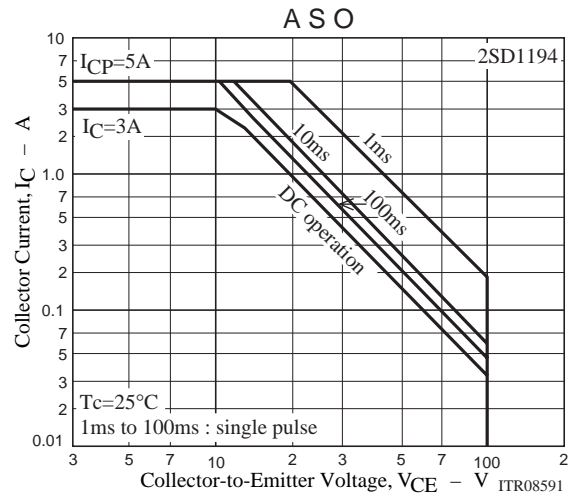
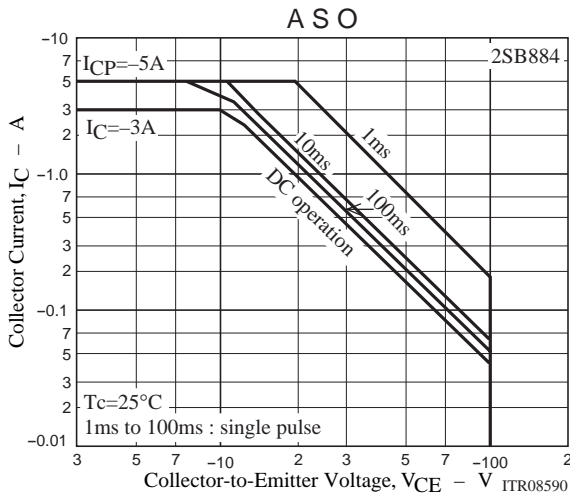

- Specifications of any and all SANYO products described or contained herein stipulate the performance, characteristics, and functions of the described products in the independent state, and are not guarantees of the performance, characteristics, and functions of the described products as mounted in the customer's products or equipment. To verify symptoms and states that cannot be evaluated in an independent device, the customer should always evaluate and test devices mounted in the customer's products or equipment.
- SANYO Electric Co., Ltd. strives to supply high-quality high-reliability products. However, any and all semiconductor products fail with some probability. It is possible that these probabilistic failures could give rise to accidents or events that could endanger human lives, that could give rise to smoke or fire, or that could cause damage to other property. When designing equipment, adopt safety measures so that these kinds of accidents or events cannot occur. Such measures include but are not limited to protective circuits and error prevention circuits for safe design, redundant design, and structural design.
- In the event that any or all SANYO products (including technical data, services) described or contained herein are controlled under any of applicable local export control laws and regulations, such products must not be exported without obtaining the export license from the authorities concerned in accordance with the above law.
- No part of this publication may be reproduced or transmitted in any form or by any means, electronic or mechanical, including photocopying and recording, or any information storage or retrieval system, or otherwise, without the prior written permission of SANYO Electric Co., Ltd.
- Any and all information described or contained herein are subject to change without notice due to product/technology improvement, etc. When designing equipment, refer to the "Delivery Specification" for the SANYO product that you intend to use.
- Information (including circuit diagrams and circuit parameters) herein is for example only; it is not guaranteed for volume production. SANYO believes information herein is accurate and reliable, but no guarantees are made or implied regarding its use or any infringements of intellectual property rights or other rights of third parties.

This catalog provides information as of December, 2002. Specifications and information herein are subject to change without notice.