



AO7403, AO7403L (Green Product)
P-Channel Enhancement Mode Field Effect Transistor

General Description

The AO7403 uses advanced trench technology to provide excellent $R_{DS(ON)}$, low gate charge, and operation with gate voltages as low as 1.8V, in the small SOT323 footprint. It can be used for a wide variety of applications, including load switching, low current inverters and low current DC-DC converters. It is ESD protected to 2KV HBM. AO7403L (Green Product) is offered in a lead-free package.

Features

- V_{DS} (V) = -20V
- I_D = -0.7A
- $R_{DS(ON)} < 470m\Omega$ ($V_{GS} = -4.5V$)
- $R_{DS(ON)} < 625m\Omega$ ($V_{GS} = -2.5V$)
- $R_{DS(ON)} < 900m\Omega$ ($V_{GS} = -1.8V$)

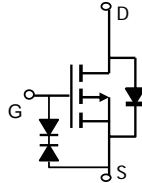
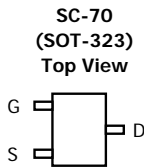

Absolute Maximum Ratings $T_A=25^\circ C$ unless otherwise noted

Parameter	Symbol	Maximum	Units
Drain-Source Voltage	V_{DS}	-20	V
Gate-Source Voltage	V_{GS}	± 8	V
Continuous Drain Current ^A	I_D	$T_A=25^\circ C$	A
		$T_A=70^\circ C$	
Pulsed Drain Current ^B	I_{DM}	-3	
Power Dissipation ^A	P_D	$T_A=25^\circ C$	0.35
		$T_A=70^\circ C$	0.22
Junction and Storage Temperature Range	T_J, T_{STG}	-55 to 150	$^\circ C$

Thermal Characteristics

Parameter	Symbol	Typ	Max	Units
Maximum Junction-to-Ambient ^A	$R_{\theta JA}$	$t \leq 10s$	300	$^\circ C/W$
Maximum Junction-to-Ambient ^A		Steady-State	350	$^\circ C/W$
Maximum Junction-to-Lead ^C	$R_{\theta JL}$	280	320	$^\circ C/W$

Electrical Characteristics (T_J=25°C unless otherwise noted)

Symbol	Parameter	Conditions	Min	Typ	Max	Units
STATIC PARAMETERS						
BV _{DSS}	Drain-Source Breakdown Voltage	I _D =-250μA, V _{GS} =0V	-20			V
I _{DSS}	Zero Gate Voltage Drain Current	V _{DS} =-16V, V _{GS} =0V T _J =55°C			-1 -5	μA
I _{GSS}	Gate-Body leakage current	V _{DS} =0V, V _{GS} =±8V			±10	μA
V _{GS(th)}	Gate Threshold Voltage	V _{DS} =V _{GS} , I _D =-250μA	-0.5	-0.6	-0.9	V
I _{D(ON)}	On state drain current	V _{GS} =-4.5V, V _{DS} =-5V	-3			A
R _{DS(ON)}	Static Drain-Source On-Resistance	V _{GS} =-4.5V, I _D =-0.7A T _J =125°C		388 542	470 660	mΩ
		V _{GS} =-2.5V, I _D =-0.6A		519	625	mΩ
		V _{GS} =-1.8V, I _D =-0.5A		666	900	mΩ
g _{FS}	Forward Transconductance	V _{DS} =-5V, I _D =-0.7A		1.7		S
V _{SD}	Diode Forward Voltage	I _S =-0.5A, V _{GS} =0V		-0.86	-1	V
I _S	Maximum Body-Diode Continuous Current				-0.4	A
DYNAMIC PARAMETERS						
C _{iss}	Input Capacitance	V _{GS} =0V, V _{DS} =-10V, f=1MHz		114		pF
C _{oss}	Output Capacitance			17		pF
C _{rss}	Reverse Transfer Capacitance			14		pF
R _g	Gate resistance	V _{GS} =0V, V _{DS} =0V, f=1MHz		12		Ω
SWITCHING PARAMETERS						
Q _g	Total Gate Charge	V _{GS} =-4.5V, V _{DS} =-10V, I _D =-0.7A		1.44		nC
Q _{gs}	Gate Source Charge			0.14		nC
Q _{gd}	Gate Drain Charge			0.35		nC
t _{D(on)}	Turn-On DelayTime	V _{GS} =-4.5V, V _{DS} =-10V, R _L =14.3Ω, R _{GEN} =3Ω		6.5		ns
t _r	Turn-On Rise Time			6.5		ns
t _{D(off)}	Turn-Off DelayTime			18.2		ns
t _f	Turn-Off Fall Time			5.5		ns
t _{rr}	Body Diode Reverse Recovery Time	I _F =-0.7A, dI/dt=100A/μs		10		ns
Q _{rr}	Body Diode Reverse Recovery Charge	I _F =-0.7A, dI/dt=100A/μs		3		nC

A: The value of R_{θJA} is measured with the device mounted on 1in² FR-4 board with 2oz. Copper, in a still air environment with T_A=25°C. The value in any a given application depends on the user's specific board design. The current rating is based on the t_s ≤ 10s thermal resistance rating.

B: Repetitive rating, pulse width limited by junction temperature.

C: The R_{θJA} is the sum of the thermal impedance from junction to lead R_{θJL} and lead to ambient.

D: The static characteristics in Figures 1 to 6, 12, 14 are obtained using 80μs pulses, duty cycle 0.5% max.

E: These tests are performed with the device mounted on 1 in² FR-4 board with 2oz. Copper, in a still air environment with T_A=25°C. The SOA curve provides a single pulse rating.

THIS PRODUCT HAS BEEN DESIGNED AND QUALIFIED FOR THE CONSUMER MARKET. APPLICATIONS OR USES AS CRITICAL COMPONENTS IN LIFE SUPPORT DEVICES OR SYSTEMS ARE NOT AUTHORIZED. AOS DOES NOT ASSUME ANY LIABILITY ARISING OUT OF SUCH APPLICATIONS OR USES OF ITS PRODUCTS. AOS RESERVES THE RIGHT TO IMPROVE PRODUCT DESIGN, FUNCTIONS AND RELIABILITY WITHOUT NOTICE

TYPICAL ELECTRICAL AND THERMAL CHARACTERISTICS

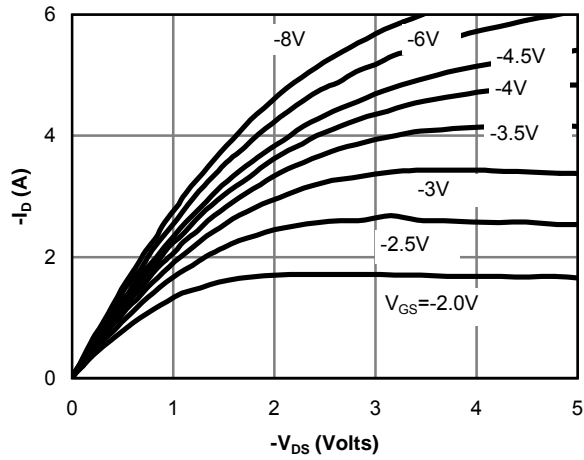

Fig 1: On-Region Characteristics

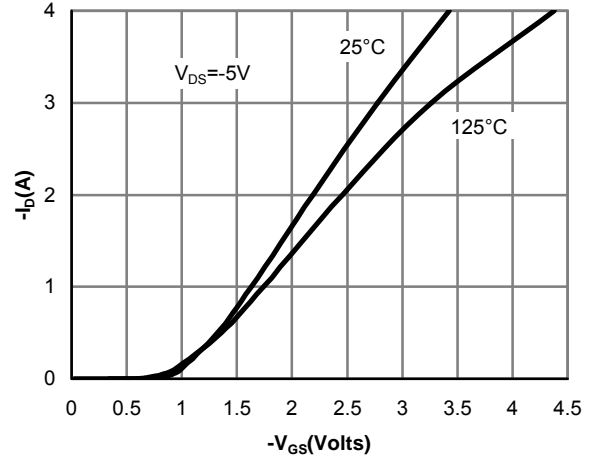

Figure 2: Transfer Characteristics

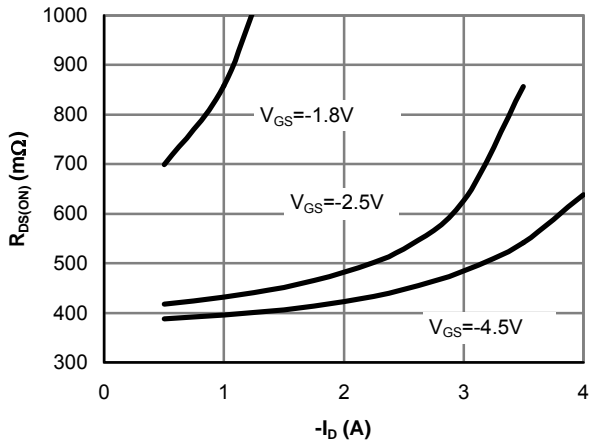

Figure 3: On-Resistance vs. Drain Current and Gate Voltage

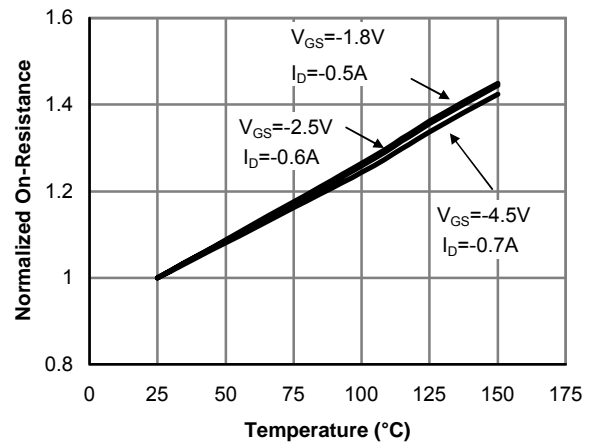

Figure 4: On-Resistance vs. Junction Temperature

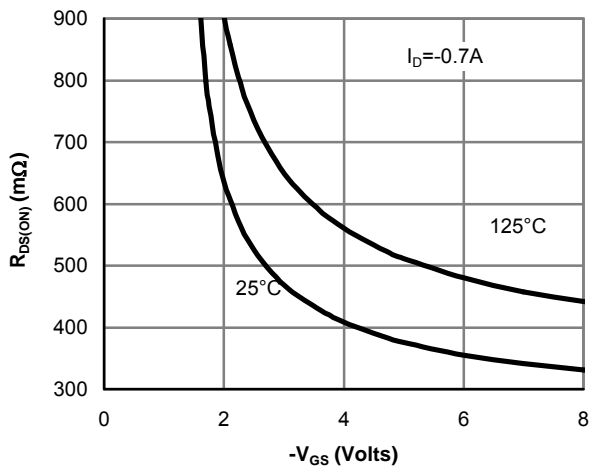

Figure 5: On-Resistance vs. Gate-Source Voltage

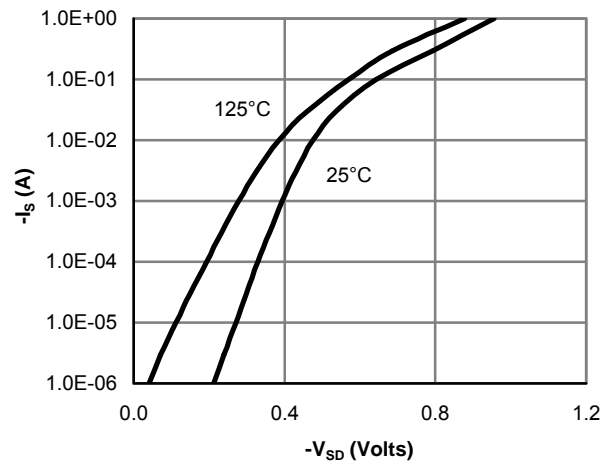

Figure 6: Body-Diode Characteristics

TYPICAL ELECTRICAL AND THERMAL CHARACTERISTICS

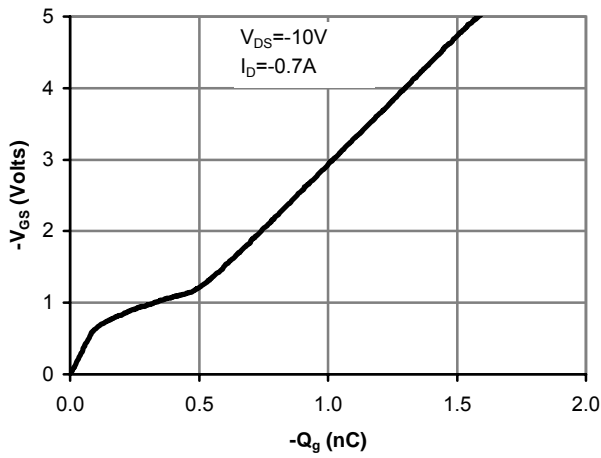

Figure 7: Gate-Charge Characteristics

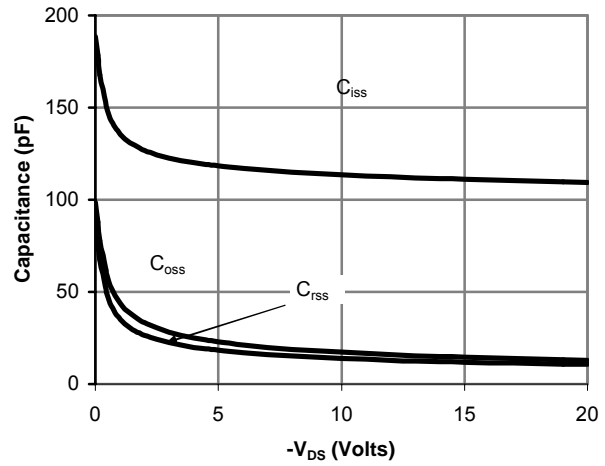

Figure 8: Capacitance Characteristics

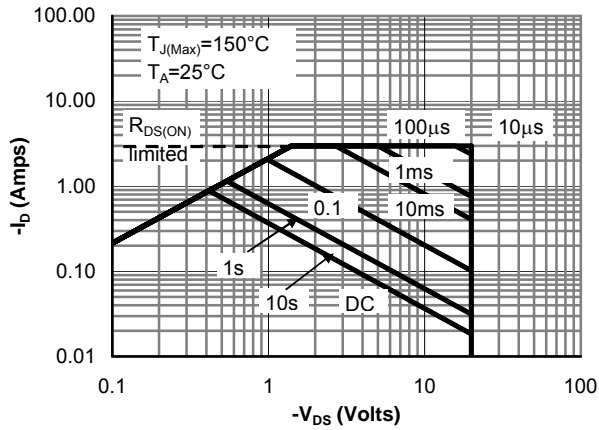

Figure 9: Maximum Forward Biased Safe Operating Area (Note E)

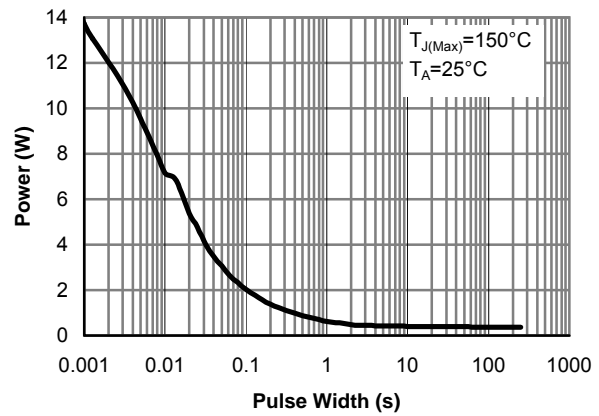

Figure 10: Single Pulse Power Rating Junction-to-Ambient (Note E)

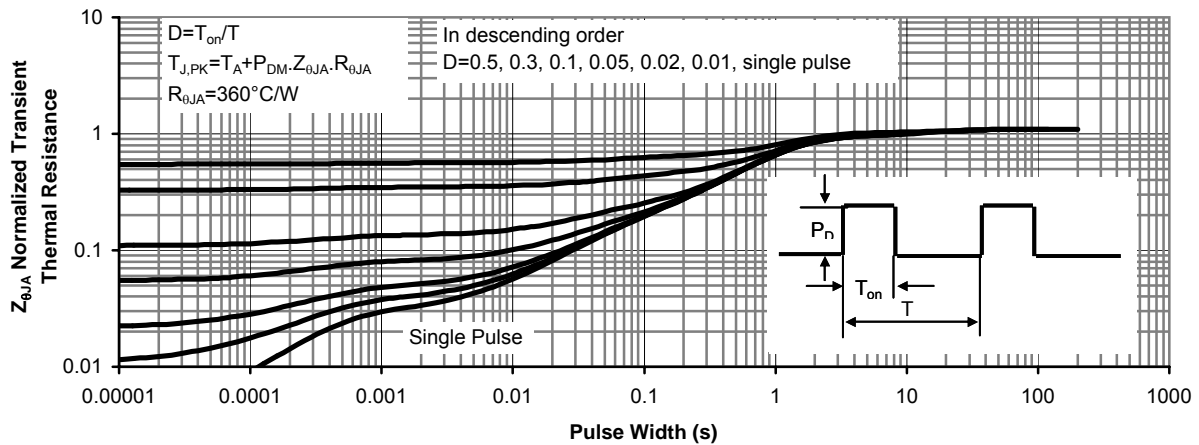

Figure 11: Normalized Maximum Transient Thermal Impedance



ALPHA & OMEGA
SEMICONDUCTOR, LTD.

Document No.	PD-00128
Version	rev C
Title	AO7403 Marking Description

SC-70(3L) PACKAGE MARKING DESCRIPTION

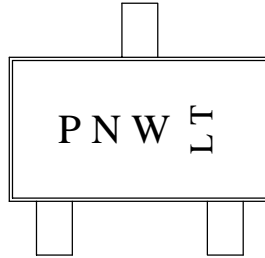

Standard product

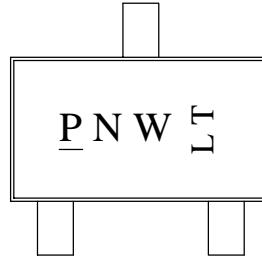

Green product

NOTE:
P - Product number code
N - Assembly&Foundry location code
W - Year and Week code
LT - Assembly lot code.

PART NO.	DESCRIPTION	CODE (P&N)
AO7403	Standard product	3&N
AO7403L	Green product	<u>3</u> &N

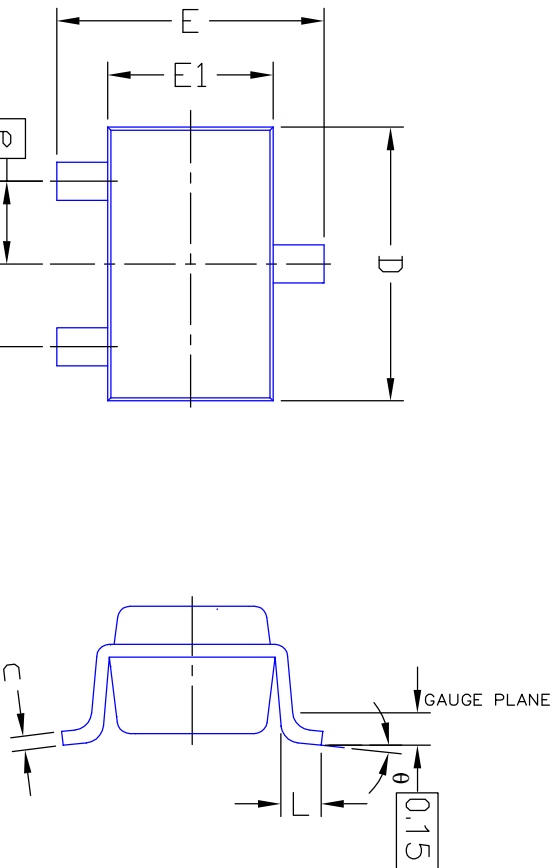

- NOTE**
1. ALL DIMENSIONS ARE IN MILLIMETERS.
 2. DIMENSIONS ARE INCLUSIVE OF PLATING.
 3. PACKAGE BODY SIZES EXCLUDE MOLD FLASH AND GATE BURRS.
 4. DIE IS FACING UP FOR MOLD AND FACING DOWN FOR TRIM/FORM. i.e: REVERSE TRIM/FORM.
 5. DIMENSION L IS MEASURED IN GAUGE PLANE.
 6. CONTROLLING DIMENSION IS MILLIMETER. CONVERTED INCH DIMENSIONS ARE NOT NECESSARILY EXACT.

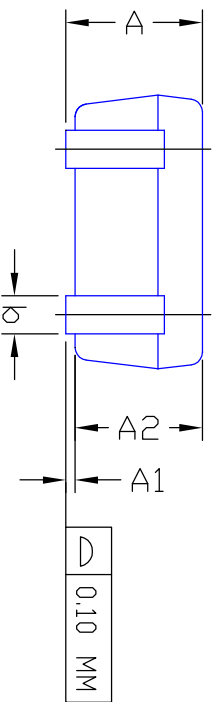

RECOMMENDATION OF LAND PATTERN

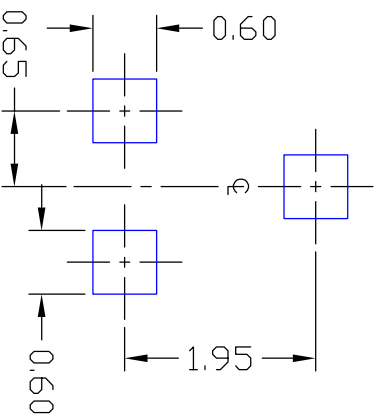

SYMBOLS	DIMENSIONS IN MILLIMETERS			DIMENSIONS IN INCHES		
	MIN	NOM	MAX	MIN	NOM	MAX
A	---	---	1.10	---	---	0.043
A1	0.00	---	0.10	0.00	---	0.004
A2	0.7	0.9	1.00	0.028	0.035	0.039
b	0.15	---	0.30	0.006	---	0.012
c	0.08	---	0.22	0.003	---	0.009
D	1.85	2.10	2.15	0.073	0.083	0.085
E	1.80	2.30	2.40	0.071	0.091	0.094
e	0.65 BSC			0.026 BSC		
e1	1.30 BSC			0.051 BSC		
E1	1.1	1.30	1.4	0.043	0.051	0.055
L	0.26	0.36	0.46	0.010	0.014	0.018
θ	0°	4°	8°	0°	4°	8°

UNIT: mm

UNLESS OTHERWISE SPECIFIED DIMENSIONS ARE IN INCHES DECIMAL XXX ± XXXX ± ANGULAR ±		THIRD ANGLE PROJECTION 			
INTERPRET DIM. AND TOL PER ASME Y14.5M - 1994 PRINTING IS SCALED TO FIT DO NOT SCALE DRAWING		Document No. PD-00012	Version rev C	ALPHA & OMEGA SEMICONDUCTOR, LTD.	
Title		SC-70-3L PACKAGE OUTLINE			



SC-70 3L Carrier Tape

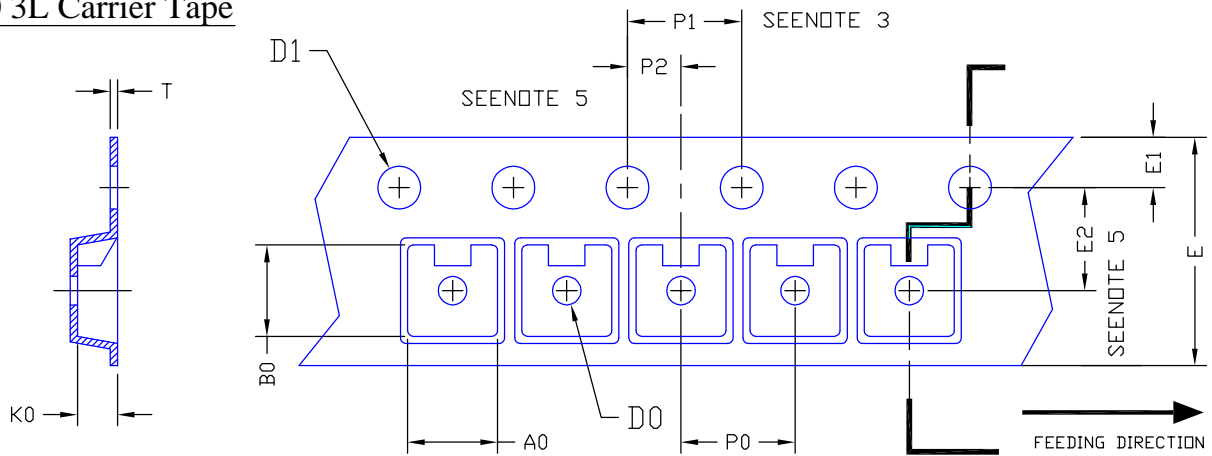

UNIT: MM

PACKAGE	A0	B0	K0	D0	D1	E	E1	E2	P0	P1	P2	T
SOT-23 (8 mm)	2.40 ±0.10	2.40 ±0.10	1.19 ±0.10	1.00 MIN	1.55 ±0.05	8.00 ±0.30	1.75 ±0.10	3.50 ±0.05	4.00 ±0.10	4.00 ±0.10	2.00 ±0.05	0.25 ±0.05

SC-70 3L Reel

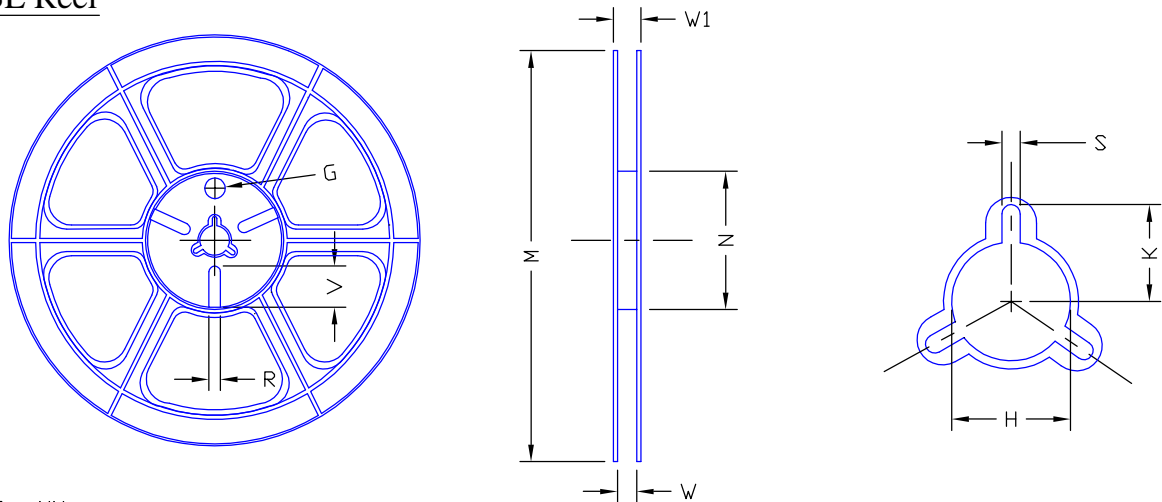

UNIT: MM

TAPE SIZE	REEL SIZE	M	N	W	W1	H	K	S	G	R	V
8 mm	ø180	ø180.00 ±0.50	ø60.50	9.00 ±0.30	11.40 ±1.00	ø13.00 +0.50 -0.20	10.60	2.00 ±0.50	ø9.00	5.00	18.00

SC-70 3L Tape

Leader / Trailer
& Orientation

