

VCR audio signal processing system

BH7779K

The BH7779K is an audio signal processing system IC that includes a peak-noise reduction processor, an FM modulator / demodulator circuit, an input / output switcher, an automatic FM detector circuit, an FM band-pass filter, a normal-audio circuit and a regulator circuit.

●Applications

VHS Video cassette recorders

●Features

- 1) An audio signal processing system IC that (Hi-Fi and normal audio) includes a peak-noise reduction (PNR) processor, an FM modulator / demodulator circuit, an input output switcher, an automatic FM detector circuit, an FM band-pass filter, a normal-audio circuit and a regulator circuit.
- 2) Operates off dual \pm power supply which allows a large reduction in the number of coupling capacitors required. A built-in regulator makes it easy to construct a power supply system.
- 3) A built-in two-line serial control decoder circuit allows serial control of the internal mode settings.
- 4) Four-input switcher (turner, BS, and line 1 and 2). The output switcher switches between STEREO / LEFT / RIGHT and Hi-Fi / MIX / NORMAL, and a BS monitor function is provided.
- 5) The PNR processor and FM modulation / demodulation circuit provide reverse characteristics at recording and playback. Also, carrier frequency adjustment and FM de-emphasis / playback level adjustment have been combined.
- 6) Built-in FM band-pass filter connects directly to the playback amplifier and excels at attenuation of the other channel. The FM recording output circuit has a high-performance high-frequency cutoff filter that produces a sine wave output.
- 7) Switching noise is reduced by a slope-control type differential compensation circuit.
- 8) Built-in envelope detector circuit and noise-detecting automatic FM detector circuit.
- 9) Built-in normal-audio signal processing circuit that allows SP / LP / EP equalizer switching. Control terminal provided for use with the BA7755AF high-voltage head switcher.

● Absolute maximum ratings (Ta=25°C)

Parameter	Symbol	Limits	Unit
Applied voltage	V _{CC}	23, 55pin.....6.0	V
	V _{EE}	59 pin..... - 6.0	V
	V _{IN}	6, 8, 9 pin.....6.5	V
	V _{IN}	Other than the pins above: 6.0V	V
Power dissipation	P _d	800*	mW
Operating temperature	T _{opr}	- 10 ~ + 70	°C
Storage temperature	T _{stg}	- 55 ~ + 125	°C

* When IC is stand alone, reduced by 8.0mW for each increase in Ta of 1°C over 25°C. When mounted on a 90mm × 50mm, t = 1.6mm glass epoxy board, Pd = 1.3W (reduced by - 13.0mW for each increase in Ta of 1°C over 25°C).

● Recommended operating conditions (Ta = 25°C)

Parameter	Symbol	Range	Unit
Power supply voltage	UNREG-V _{CC}	+ 7.0 ~ *	V
Power supply voltage	UNREG-V _{EE}	+ 7.0 ~ *	V

* The built-in regulator in this IC outputs + 5.0V from pin 55, and - 5.0V from pin 59. The power supply voltage given above is the voltage to be applied to UNREG V_{CC} and UNREG V_{EE} pins in the measurement circuit to obtain regulator output. Therefore, the upper limit of the power supply voltage is set by the externally connected transistor that forms the regulator circuit, and not by the IC itself. Note, also, that the lower limit will change depending on the value of the resistor connected between the collector and base of the transistor.

●Block diagram

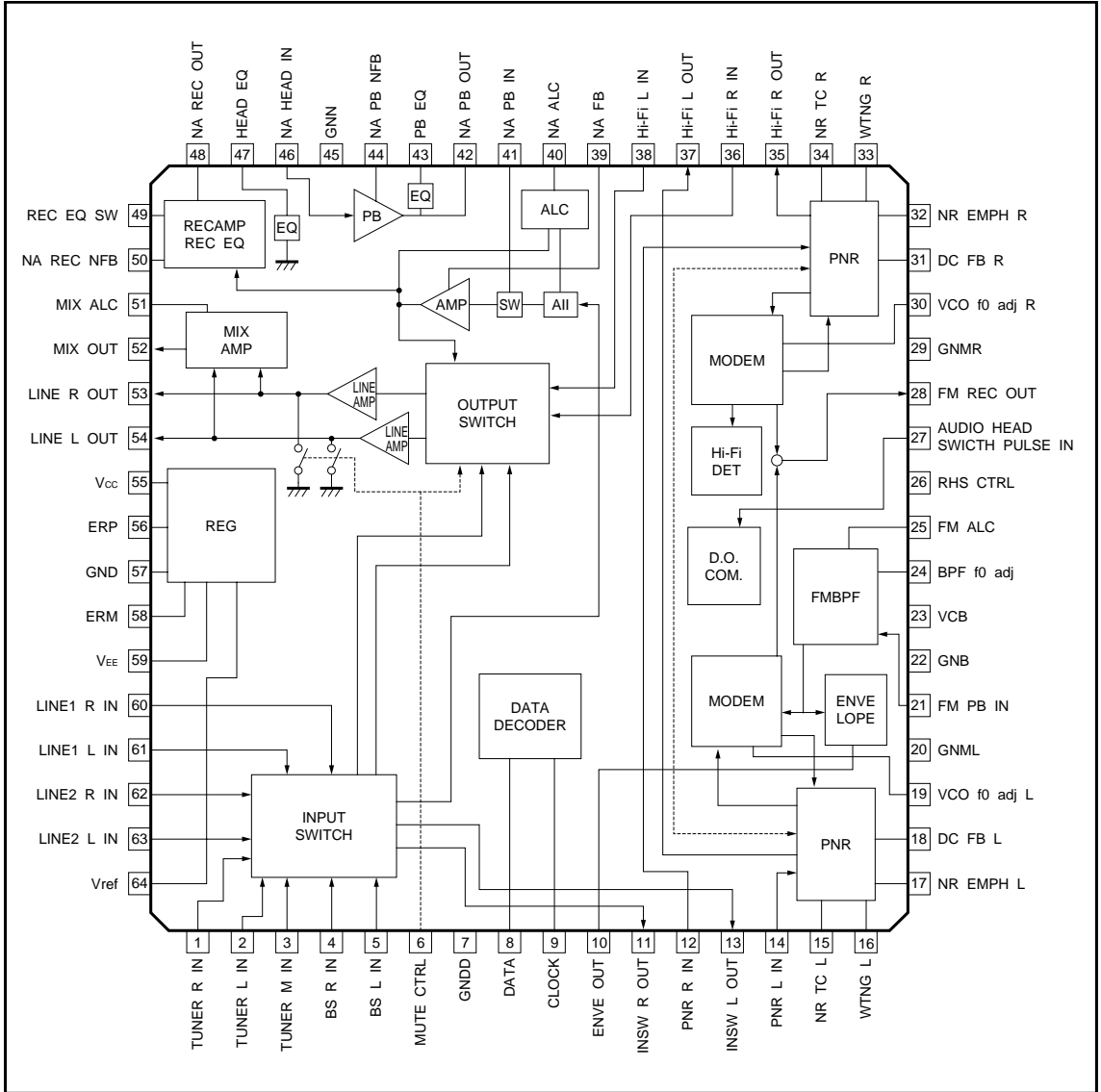

●Pin descriptions

Pin function - 1 / 3

Pin No.	Pin name	Function	Pin voltage	I / O circuit
2, 1, 3	TUNER IN L, R, M	TUNER input (L, R, and M).	0.0V	32.7kΩ
5, 4	BS IN L, R	BS input (L and R).	0.0V	93.5kΩ
6	MUTE CTRL	Line output mute control input.	—	3kΩ (more 2.5V)
7	GNDD	Serial control GND.	—	—
8	DATA IN	Serial control data input.	—	B (PNP)
9	CLOCK IN	Serial control clock input.	—	B (PNP)
10	ENVE OUT	FM input Lch signal component envelope output.	EE: 0.8V PB: 1.0V	EE: 50kΩ PB: EF (NPN)
13, 11	INPUTSWOUT L, R	Input SW output.	0.0V	EF: (P - P)
14, 12	PNR IN L, R	PNR audio input.	0.0V	50kΩ
15, 34	NR TC L, R	PNR attack and recovery time setting. Attack R: 530Ω, recovery R: 6.5kΩ.	-5.0V	—
16, 33	WTNG L, G	Waiting characteristic high-frequency time constant setting.	0.0V	—
17, 32	NR EMPH L, R	NR emphasis time constant setting. (external C = 0.01μF, R = 18kΩ, 5.6kΩ)	0.0V	—
18, 31	DC FB L, R	PNR operating reference potential.	0.0V	11.5kΩ
19, 30	VCO f ₀ ADJ L, R	VCO control current setting terminal.	2.5V	EF(NPN)
20, 29	GND (GNM) L, R	PNR and MODEM GND. Both L and R unconnected.	0.0V	—
21	FM PB IN	Playback FM input. 660mV _{P-P} Typ. No input coupling capacitor (GND to V _{CC}).	0.0V	33kΩ
22	GND (GNB)	FM BPF GND.	0.0V	—

* I / O circuit; EF: emitter follower, P-P: push pull, B: base, and C: collector.
All numerical values are standardized values.

Pin function - 2 / 3

Pin No.	Pin name	Function	Pin voltage	I / O circuit
23	VCB	MODEM and BPF V _{cc} .	5.0V	—
24	BPF f ₀ ADJ	BPF center frequency adjustment.	1.9V	EF (NPN) ~ 200Ω
25	FM ALC	FM ALC time constant setting.	0.0V	EF (NPN) ~ 2.5kΩ
26	REC HSW CTRL	High-voltage head switch control (BA7755).	—	C (NPN)
27	AHSWP IN	Audio head switching pulse input.	—	B (PNP)
28	FM REC OUT	EE: recording FM output. Sine wave output. PB: BPF output monitor.	EE: 3.3V PB: 3.3V	EF (NPN) ~ 200Ω
37, 35	Hi-Fi OUT L, R	PNR audio output.	0.0V	EF: (P - P)
38, 36	Hi-Fi IN L, R	Hi - Fi input for output switcher.	0.0V	47kΩ
39	NA FB	Normal line amplifier feedback.	0.0V	800Ω
40	NA ALC	Normal line amplifier ALC time constant setting. Attack and recovery time setting.	0.0V	EF (NPN) ~ 500Ω
41	NA PB IN	Normal line amplifier playback input.	0.0V	100kΩ
42	NA PB OUT	Normal PB amplifier output.	0.0V	EF (P - P) ~ 50Ω
43	PB EQ	Normal PB amplifier equalizer switch.	0.0V	OPEN / 22Ω
44	NA PB NFB	Normal PB amplifier feedback.	0.0V	B (NPN)
45	GNN	Normal audio GND.	0.0V	—

* I / O circuit; EF: emitter follower, P-P: push pull, B: base, and C: collector.
All numerical values are standardized values.

Pin function - 3 / 3

Pin No.	Pin name	Function	Pin voltage	I / O circuit
46	NA HEAD IN	Normal audio playback input.	0.0V	REC: B (NPN) REC: EF (PNP)
47	HEAD EQ	Head resonance equalizer switch.	0.0V	300kΩ / 28Ω
48	NA REC OUT	Normal REC amplifier output.	0.0V	EF: (P - P)
49	REC EQ	Recording equalizer switch.	0.0V	100kΩ / 22Ω
50	NA REC FB	Normal REC amplifier feedback.	0.0V	B (NPN)
51	MIX ALC	ALC time constant setting for mixer amplifier Attack and recovery time setting.	- 5.0V	EF (NPN) ~ 500Ω
52	MIX OUT	Mixer amplifier output for RF converter.	0.0V	EF (NPN)
54, 53	LINE OUT L, R	Line output	0.0V	330Ω
55	V _{cc}	V _{cc} regulator.	5.0V	—
56	ERP	V _{cc} regulator error output.	5.0V	C (NPN)
57	GND	Input / output switch GND.	0.0V	—
58	ERM	V _{EE} regulator error output.	- 5.0V	C (PNP)
59	V _{EE}	V _{EE} regulator.	- 5.0V	—
61, 60	LINE1 IN L, R	LINE 1 input (L and R).	0.0V	93.5kΩ
63, 62	LINE2 IN L, R	LINE 2 input (L and R).	0.0V	93.5kΩ
64	VREFP	V _{cc} / 2 reference voltage. With power on detect and precharge function.	2.5V	10kΩ

* I / O circuit; EF: emitter follower, P-P: push pull, B: base, and C: collector.
All numerical values are standardized values.

●Input / Output circuits

Equivalent circuits for the control and input / output circuits - (1)

TUNER L, R, M (2, 1, 3pin)

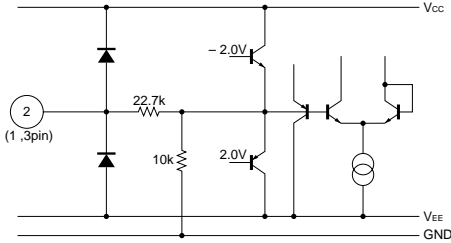

LINE1 L / R, LINE2 L / R, BS L / R (61, 60, 63, 62, 5, 4pin)

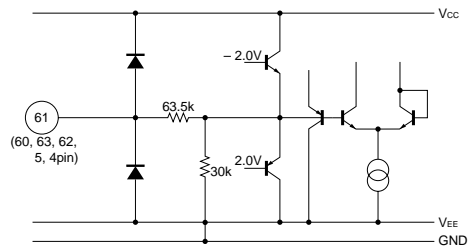

LINE OUT L, R (54, 53pin)

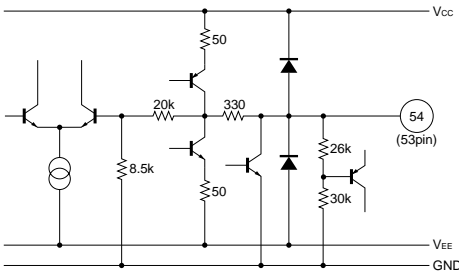

MIX OUT (52pin)

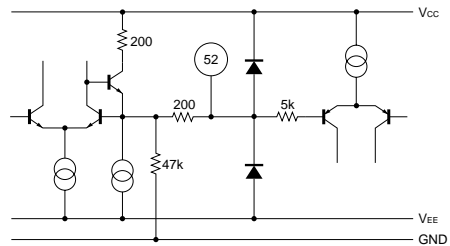

FM REC OUT (28pin)

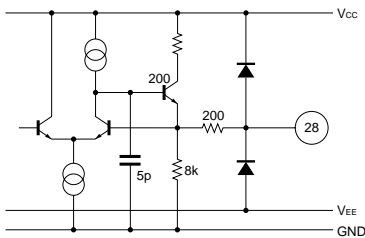

FM BP IN (21pin)

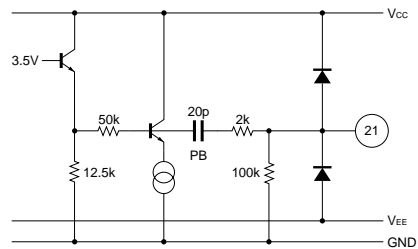

Equivalent circuits for the control and input / output circuits - (2)

NA PB IN (41pin)

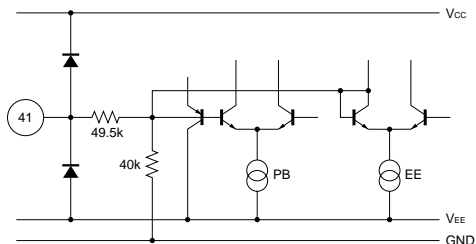

NA PB OUT (42pin)

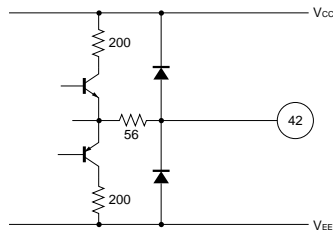

NA PB NFB (44pin) ,NA HEAD IN (46pin)

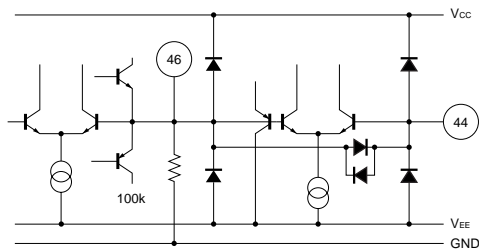

NA REC OUT (48pin) ,NA REC NFB (50pin)

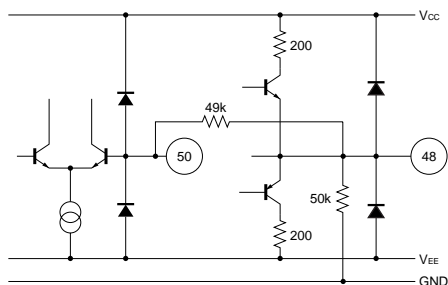

Equivalent circuits for the control and input / output circuits - (3)

AUDIO HEAD SWITCH PULSE IN (27pin)

ENVELOPE / Hi - Fi DET OUT (10pin)

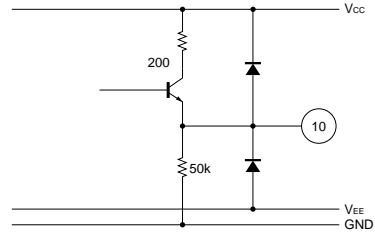
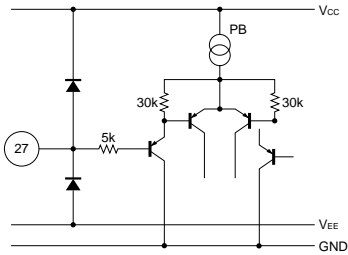

RHS CTRL (26pin)

MUTE CTRL (6pin)

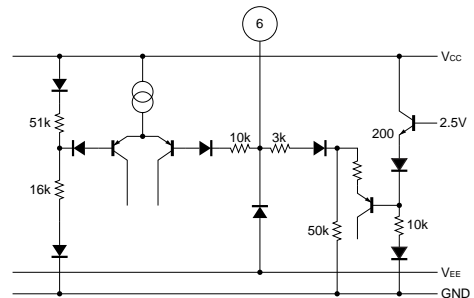
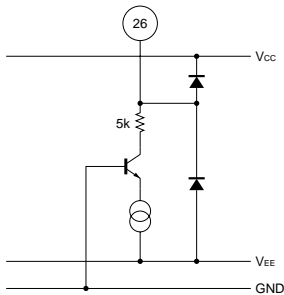

DATA (8pin) , CLOCK (9pin)

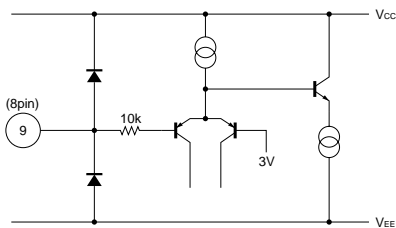

●Electrical characteristics

- Unless otherwise noted, the following measurement conditions apply:

UNREG – $V_{CC} = +10V$

UNREG – $V_{EE} = -10V$

$T_a = 25^{\circ}C$

*With regard to the control voltages, refer to the mode holding voltage range given in p. 185.

- Output switch control (W1D2, W1D3 and W1D4) : STEREO
- BS through control (W3D7) : OFF
- LINE AMP gain (W2D1 and W2D2) : Standard (+ 10.3dB)
- FM output control (W4D1) : FM output on
- FM OUT switch control (W4D2, W4D3 and W4D4) : FM REC output MIX ratio (– 13.5dB)
- NTSC / PAL control (W2D6) : NTSC
- Recording mute (W1D6) : recording \overline{MUTE}
- SP / EP control (W1D7) : SP
- FM detector level control (W2D3, W2D4) : standard
- ENVE characteristic control (W2D5) : FNORM detector, no ENVE output
- FM TEST control (W4D5) : OFF
- FM ALC control (W4D6) : ALC ON
- MUTE CTRL (pin 6) : L (\overline{MUTE})

Signal frequency $f = 1kHz$

MODEM carrier frequency NTSC Lch 1.30MHz

MODEM carrier frequency NTSC Rch 1.70MHz

MODEM carrier frequency PAL Lch 1.4MHz

MODEM carrier frequency PAL Rch 1.8MHz

*1 B.W. = 0.4 to 30kHz

*2 DIN AUDIO

* Refer to Fig. 1 for the measurement circuit.

Parameter	Symbol	Min.	Typ.	Max.	Unit	Conditions
<REGULATOR>						
Quiescent current (positive supply) EE	$I_{qp EE}$	26.0	34.7	46.3	mA	EE mode, no input, standard carrier adjustment resistor.
Quiescent current (positive supply) PB	$I_{qp PB}$	36.4	48.6	64.8	mA	PB mode, no input, FNORM, BPE, standard carrier adjustment resistor.
Quiescent current (negative supply) EE	$I_{qm EE}$	-20.1	-15.1	-11.3	mA	EE mode, no input, standard carrier adjustment resistor.
Quiescent current (negative supply) PB	$I_{qm PB}$	-21.6	-16.2	-12.1	mA	PB mode, no input, FNORM, BPE, standard carrier adjustment resistor.
Regulator input voltage (+)	V_{CC}	4.69	5.04	5.39	V	—
Regulator input voltage (-)	V_{EE}	-5.37	-5.02	-4.67	V	—

Parameter	Symbol	Min.	Typ.	Max.	Unit	Conditions
〈Hi-Fi EE THROUGH〉 (INPUT: TU IN L / R, LINE1 IN L / R, LINE2 IN L / R, BS IN L / R OUTPUT: LINE OUT L / R)						
〈MANUAL MODE〉						
Line output level	V _{OEE}	-11.0	-9.8	-8.6	dBV	V _{IN} = -9.7dBV
Channel balance (L / R)	CR _{EE}	-0.8	0.0	0.8	dB	V _{IN} = -9.7dBV
Distortion	THD _{EE}	—	0.017	0.10	%	V _{IN} = -9.7dBV,*1
Maximum output level	V _{OMEE}	8.3	10.7	—	dBV	THD = 1%,*1
Output residual noise	V _{ONEE}	—	-94.0	-85.0	dBV	Connect the pertinent input to GND.*2
Crosstalk	CT _{EE}	—	-93.0	-78.0	dBV	V _{IN} = 0.0dBV for the non-relevant terminal, relevant terminal shorted to GND.*2
Muting level	MT _{EE}	—	-105	-95	dBV	V _{IN} = 0.0dBV,*2
Switching DC offset	ΔV _{MODE}	—	8.0	30	mV	(LINE OUT) ST / L / R / N, MIX ON / OFF Mode switching operating point voltage difference.
〈BS THROUGH〉 (INPUT: BS IN L / R OUTPUT: LINE OUT L / R)						
Output level	V _{OBS}	-10.9	-9.7	-8.5	dBV	V _{IN} = -9.7dBV
Distortion	THD _{BS}	—	0.005	0.08	%	V _{IN} = -9.7dBV,*1
Output residual noise	V _{ONBS}	—	-99.0	-87.0	dBV	Connect BS IN to GND.*2
〈LINE AMP〉 (INPUT: HI-FI IN L / R OUTPUT: LINE OUT L / R)						
Line amplifier gain 1	V _{LINE1}	+9.3	+10.3	+11.3	dB	V _{IN} = -20.0dBV
〈MIX AMP〉 (INPUT: TU IN L / R, LINE1 IN L / R, LINE2 IN L / R, BS IN L / R OUTPUT: MIX OUT)						
Output level	V _{OMIX}	-11.7	-9.7	-7.7	dBV	V _{IN} = -9.7dBV, simultaneous L & R input
Distortion	THD _{MIX}	—	0.08	0.50	%	V _{IN} = -9.7dBV, simultaneous L & R input*1
MIX ALC level	V _{ALCMIX}	-4.9	-2.9	-0.9	dBV	V _{IN} = 0.0dBV, simultaneous L & R input
〈NORMAL EE THROUGH〉 (INPUT: TU IN M, TU IN L / R, LINE1 IN L / R, LINE2 IN L / R, BS IN L / R OUTPUT: LINE OUT L / R)						
Output voltage level	V _{OEE}	-11.3	-10.1	-8.9	dBV	V _{IN} = -9.7dBV
Distortion	THD _{EEEN}	—	0.045	0.10	%	V _{IN} = -9.7dBV,*1
Output residual noise	V _{ONEEN}	—	-80.0	-70.0	dBV	R _g = 1kΩ,*2
ALC level 1	V _{ALCN1}	-8.5	-7.0	-5.5	dBV	V _{IN} = -5.0dBV
ALC distortion	THD _{ALCN}	—	0.040	0.15	%	V _{IN} = -5.0dBV,*1
〈NORMAL REC AMP〉 (INPUT: TU IN M, TU IN L / R, LINE1 IN L / R, LINE2 IN L / R, BS IN L / R OUTPUT: NA REC OUT)						
Output voltage level	V _{ORECN}	-11.4	-10.2	-9.0	dBV	V _{IN} = -9.7dBV
Distortion	THD _{RECN}	—	0.067	0.20	%	V _{IN} = -9.7dBV,*1
Maximum output level	V _{OMRECN}	7.0	9.3	—	dBV	THD = 1%,*1, ALC OFF
Output level for EE	MT _{RECN}	—	-99.0	-70.0	dBV	V _{IN} = 0.0dBV,*2, EE MODE ALC OFF

Parameter	Symbol	Min.	Typ.	Max.	Unit	Conditions	
〈NORMAL PB AMP〉 (INPUT: NA HEAD IN, OUTPUT: LINE OUT)							
Output voltage level	V _{OPBN}	-11.9	-10.1	-8.3	dB	V _{IN} = -70dBV	
Distortion	THD _{PBN}	—	0.15	0.40	%	V _{IN} = -70dBV,*1	
Output residual noise	V _{ONPBN}	—	-61.5	-53.0	dBV	R _g = 1k Ω ,*2	
Open loop gain (PB PRE AMP)	G _{V_{PBNOR}}	58.0	65.5	—	dB	V _{IN} = -70dBV OUTPUT: NA PB OUT	
〈EQ SWITCH〉							
REC EQ SW impedance	R _{EQ REC}	—	22	40	Ω	SP MODE	
PB EQ SW impedance	R _{EQ PB}	—	25	50	Ω	SP MODE	
HEAD EQ SW impedance	R _{EQ HEAD}	—	29	50	Ω	EP MODE	
〈RHS CONTROL〉							
RHS control current	I _{IN RHS}	98	118	140	μ A	—	
RHS control leakage current	I _{L RHS}	—	—	1	μ A	—	
〈PNR ENCODE MODE〉							
Compression characteristic	CMP	—	-24.6	—	dB	Input V _{IN} = -9.7dBV \rightarrow -59.7dBV output level difference.	
Encode distortion	THD _{END}	—	0.17	—	%	V _{IN} = -9.7dBV,*1	
Output residual noise	V _{ONENC}	—	-56.5	—	dBV	Connect the pertinent input to GND.*2	
〈PNR DECODE MODE〉							
Expansion characteristic	EXP	—	-50.3	—	dB	V _{IN} = -15.5dBV \rightarrow -40.5dBV output level difference.	
Time constant setting resistance value	R _{DET}	5.10	6.15	7.20	k Ω	Resistance value connected between pins 15 and 34 and V _{EE} . (when V _{CCS} and V _{EES} applied)	
〈MODEM REC MODE〉 (INPUT: TUNER IN L / R, LINE1 IN L / R, LINE2 IN L / R, BS IN L / R, OUTPUT: FM REC OUT L / R)							
Carrier setting resistance value	Lch	R _{OL}	12.5	15.0	17.5	k Ω	No input
	Rch	R _{OR}	9.5	11.5	13.5	k Ω	
Frequency deviation	Lch	DEV _L	46.2	52.2	58.2	\pm kHz	V _{IN} = -9.7dBV
	Rch	DEV _R	46.6	52.6	58.6	\pm kHz	
Maximum frequency deviation	Lch	DEV _{Max.L}	125	147	169	\pm kHz	V _{IN} = +5.0dBV (f = 10kHz)
	Rch	DEV _{Max.R}	125	147	169	\pm kHz	
FM output level	Lch	V _{OFML}	325	370	425	mV _{P-P}	FM OUT SW: FM L mode
	Rch	V _{OFMR}	335	380	435	mV _{P-P}	FM OUT SW: FM R mode
Carrier 2nd harmonic	Lch	f _{2L}	—	-53.0	-40.0	dB	2nd stage harmonics and fundamental harmonics spectrum ratio Lch: FM L mode, Rch: FM R mode
	Rch	f _{2R}	—	-48.0	-40.0	dB	
Carrier 3rd harmonic	Lch	f _{3L}	—	-52.0	-40.0	dB	3rd stage harmonics and fundamental harmonics spectrum ratio Lch: FM L mode, Rch: FM R mode
	Rch	f _{3R}	—	-55.0	-42.0	dB	
FM MIX ratio (FM MIX1 mode)	f _{LR}	-15.7	-13.7	-11.7	dB	1.3MHz / 1.7MHz spectrum ratio.	

Parameter	Symbol	Min.	Typ.	Max.	Unit	Conditions	
(MODEM PB MODE) (INPUT: FM PB IN, OUTPUT: LINE OUT L / R)							
Carrier setting resistance, after BPF f_0 adjustment, $V_{IN} = 660mV_{P-P}$, 1.30MHz, 1.70MHz MIX IN							
Demodulation output level	Lch	V_{ODL}	-12.7	-10.7	-8.7	dBV	$DEV_L = \pm 50.0kHz$, $f = 1kHz$
	Rch	V_{ODR}	-12.7	-10.7	-8.7	dBV	$DEV_R = \pm 50.0kHz$, $f = 1kHz$
Demodulation output level 2	Lch	V_{ODL2}	V_{ODL} -9.6	V_{ODL} -7.4	V_{ODL} -5.2	dBV	$DEV_L = \pm 50.0kHz$, $f = 10kHz$
	Rch	V_{ODR2}	V_{ODR} -9.6	V_{ODR} -7.4	V_{ODR} -5.2	dBV	$DEV_R = \pm 50.0kHz$, $f = 10kHz$
Demodulation distortion	Lch	THD_{DL}	—	0.12	0.35	%	$DEV_L = \pm 50.0kHz$, $f = 1kHz$, *1
	Rch	THD_{DR}	—	0.13	0.35	%	$DEV_R = \pm 50.0kHz$, $f = 1kHz$, *1
Demodulation SW noise	Lch	V_{ODSWL}	—	—	—	dBV	$f = 10kHz$, AUDIO H. SW. $P = 30Hz$, $5V_{P-P}$ rectangular-waveform input. After 10kHz TRAP passes $DEV. = \pm 25.0kHz$ *2
	Rch	V_{ODSWR}	—	—	—	dBV	
Demodulation noise level	Lch	V_{ONDL}	—	-98.0	-88.0	dBV	Unmodulated
	Rch	V_{ONDR}	—	-98.0	-88.0	dBV	*2
(Recording→playback total characteristics) (EE---INPUT: LINE IN L / R, OUTPUT: LINE OUT L / R) (PB---INPUT: FM PB IN, OUTPUT: LINE OUT L / R)							
Line output recording / playback level difference	Lch	V_{RPL}	-1.2	0.0	+1.2	dB	EE mode: $V_{IN} = -9.7dBV$, R_0 adjusted. PB mode: Input FM PB IN = $660mV_{P-P}$, $f = 1.30MHz / 1.70MHz$ 1:1 MIX. Input $DEV = DEV_{L,R}$ (frequency deviation given above). EE / PB line out level difference.
	Rch	V_{RPR}	-1.2	0.0	+1.2	dB	
(FM BPF) (INPUT: FMPB IN, OUTPUT: BPF MONITOR L / R)							
BPF center frequency setting resistance value	R_{OBPF}	19.6	25.2	30.7	$k\Omega$	NTSC $f = 1.505MHz$, $V_{IN} = 200mV_{P-P}$ When BPF L and R output levels same.	
Lch, Rch mix input signal level, $660mV_{P-P}$ (RATIO 1:1)							
NTSC Lch							
1.30MHz insertion loss	ATT_{NLC}	-14.1	-11.1	-8.1	dB	1.30MHz + 1.70MHz When FM ALC is ON	
1.15MHz attenuation	ATT_{NL} 1.15	ATT_{NLC} -9.8	ATT_{NLC} -5.3	ATT_{NLC} -2.3	dB	1.15MHz + 1.70MHz	
1.45MHz attenuation	ATT_{NL} 1.45	ATT_{NLC} -8.1	ATT_{NLC} -5.0	ATT_{NLC} -2.5	dB	1.45MHz + 1.70MHz	
1.70MHz attenuation	ATT_{NL} 1.70	—	—	ATT_{NLC}	dB	1.30MHz + 1.70MHz	

Parameter	Symbol	Min.	Typ.	Max.	Unit	Conditions
NTSC Rch						
1.70MHz insertion loss	ATT _{NRC}	-15.3	-12.3	-9.3	dB	1.30MHz + 1.70MHz When FM ALC is ON
1.55MHz attenuation	ATT _{NR} 1.55	ATT _{NRC} -8.8	ATT _{NRC} -5.7	ATT _{NRC} -3.4	dB	1.55MHz + 1.30MHz
1.85MHz attenuation	ATT _{NR} 1.85	ATT _{NRC} -9.5	ATT _{NRC} -4.7	ATT _{NRC} -1.4	dB	1.85MHz + 1.30MHz
1.30MHz attenuation	ATT _{NR} 1.30	—	—	ATT _{NRC} -30.0	dB	1.30MHz + 1.70MHz
PAL Lch						
1.40MHz insertion loss	ATT _{PLC}	-12.9	-9.9	-6.9	dB	1.40MHz + 1.80MHz
1.80MHz attenuation	ATT _{PL} 1.80	—	—	ATT _{PLC} -30.0	dB	1.40MHz + 1.80MHz
PAL Rch						
1.80MHz insertion loss	ATT _{PRC}	-14.3	-11.3	-8.3	dB	1.40MHz + 1.80MHz
1.40MHz attenuation	ATT _{PR} 1.40	—	—	ATT _{PLC} -30.0	dB	1.40MHz + 1.80MHz
<DO detect circuit>						
DO detector level	V _{DDO}	—	83.0	—	dB μ	Input level to give DO due to attenuation.
<FNORM to Hi-Fi return delay circuit>						
Return delay time	τ_{FNPLY}	110	125	140	ms	FM PB IN (1.3MHz, 1.7MHz, 1:1 MIX) time from 660mV _{P-P} input to ENVE OUT rise. Audio head pulse in: f = 30Hz, 5V _{P-P} rectangular waveform.
<Envelope detect circuit> (INPUT: FM PB IN, OUTPUT: ENVE OUT) 0dB = 660mV _{P-P} , 1.3MHz & 1.7MHz MIX input						
Envelope output level SP0	V _{ENVSP0}	—	0	100	mV	No signal, SP MODE
Envelope output level SP1	V _{ENVSP1}	2.08	2.58	3.08	V	V _{IN} = 0dB, SP MODE
Envelope output level SP2	V _{ENVSP2}	3.70	3.95	4.20	V	V _{IN} = + 10dB, SP MODE
Envelope output level EP1	V _{ENVEP1}	1.96	2.46	2.96	V	V _{IN} = - 4dB, EP MODE
<Hold pulse circuit>						
Audio head switch pulse threshold voltage	V _{THHOLD}	1.5	2.9	3.9	V	Hysteresis (0.5V)
Hold pulse width	Δ _T HOLD	—	7.77	—	μ s	—
<Control system mode holding voltages>						
CLOCK IN						
L mode holding voltage	V _{H9L}	0.0	—	0.5	V	—
H mode holding voltage	V _{H9H}	2.5	—	V _{CC}	V	—
DATA IN						
L mode holding voltage	V _{H8L}	0.0	—	0.5	V	—
H mode holding voltage	V _{H8H}	2.5	—	V _{CC}	V	—
MUTE CTRL						
MUTE holding voltage	V _{H6L}	0.0	—	1.0	V	—
DC MUTE holding voltage	V _{H6H}	3.9	—	V _{CC}	V	—

● Application circuit example

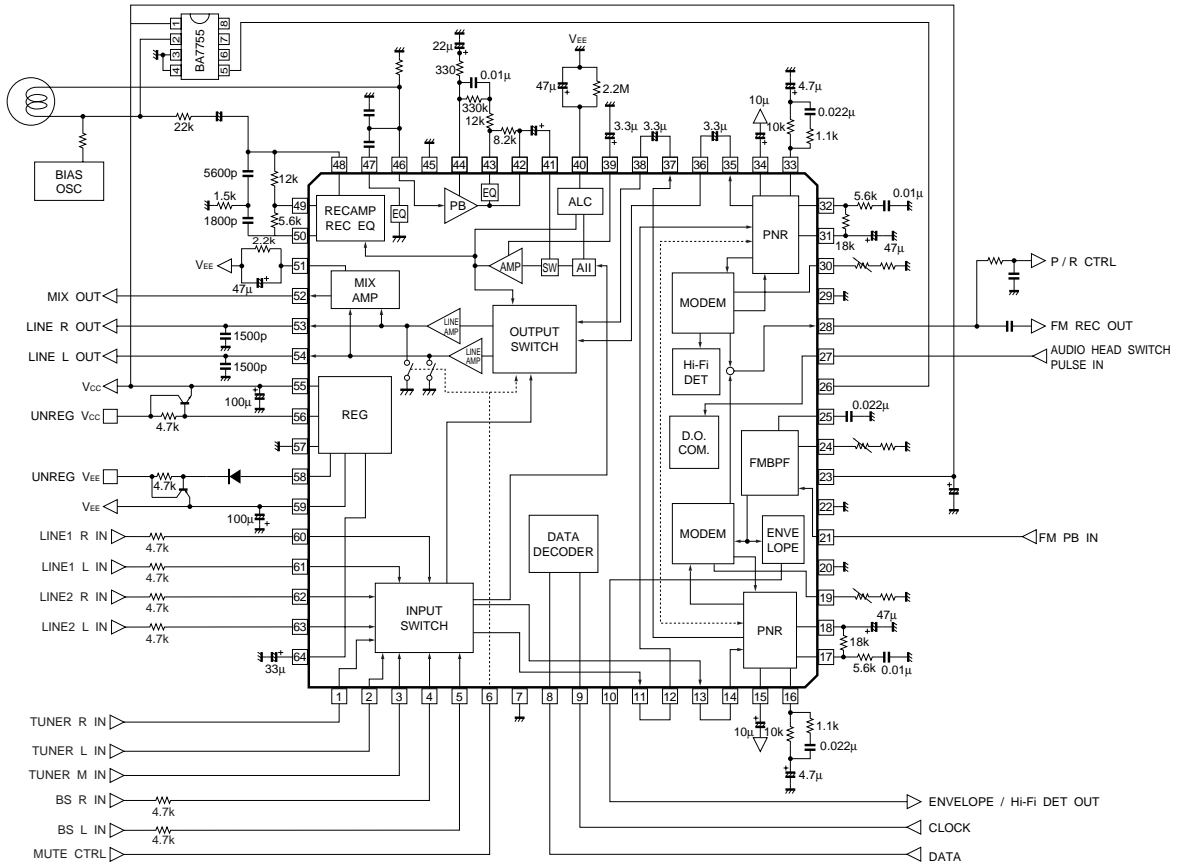

Fig.2

●Electrical characteristic curve

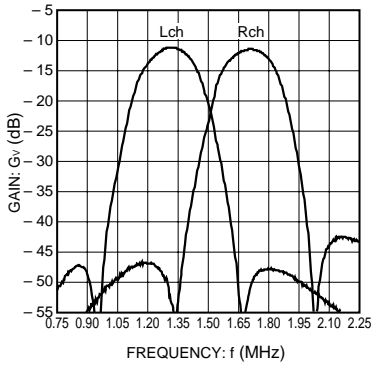

Fig. 3 FM BPF frequency characteristics (NTSC)

●External dimensions (Units: mm)

