

BIDI™ Transceiver Optical Module 1550 nm Emitting-/1300 nm Receiving Function, Low Power

SBL 81314X

Preliminary Data

- Designed for application in passive-optical networks
- Integrated Wavelength Division Multiplexer
- Bidirectional Transmission in 2nd and 3rd optical window
- Laser diode with Multi-Quantum Well structure
- Suitable for bit rates up to 1 Gbit/s
- Ternary Photodiode at rear mirror for monitoring and control of radiant power
- Low noise/high bandwidth PIN diode
- Hermetically sealed subcomponents, similar to TO 18
- With singlemode fiber pigtail



Type	Ordering Code	Connector
SBL 81314A	Q62702-P3047	DIN
SBL 81314G	Q62702-Pxxxx	FC / PC

Component with other connector types on request.

Maximum Ratings

Output power ratings refer to the optical port. The operating temperature of the submount is identical to the case temperature.

Parameter	Symbol	Values	Unit
-----------	--------	--------	------

Module

Operating temperature range at case	T_C	- 40 ... + 85	°C
Storage temperature range	T_{stg}	- 40 ... + 85	°C
Soldering temperature $t_{max} = 30$ s, 2 mm distance from bottom edge of case	T_S	260	°C

Laser Diode

Forward current	$I_{F\ max}$	150	mA
Radiant power CW	Φ_e	1	mW
Reverse voltage	$V_{R\ max}$	2	V

Maximum Ratings (cont'd)

Parameter	Symbol	Values	Unit
-----------	--------	--------	------

Monitor Diode

Forward current	$I_{F \max}$	2	mA
Reverse voltage	$V_{R \max}$	10	V

PIN Photodiode

Forward current	$I_{F \max}$	2	mA
Reverse voltage	V_{BR}	10	V
Maximum optical power into the optical port	$\Phi_{\text{port max}}$	1.5	mW

Characteristics

All optical data refer to the optical port, $T_C = 25 \text{ }^\circ\text{C}$.

Parameter	Symbol	Values	Unit
-----------	--------	--------	------

Laser Diode

Optical output power	Φ_e	> 0.4	mW
Emission wavelength center of range $\Phi_e = 0.2 \text{ mW}$	λ	1510 ... 1590	nm
Spectral bandwidth $\Phi_e = 0.2 \text{ mW}$ (RMS)	$\Delta\lambda$	5	nm
Threshold current (– 40 ... + 85 °C)	I_{th}	8 ... 60	mA
Forward voltage $\Phi_e = 0.2 \text{ mW}$	V_F	< 1.5	V
Radiant power at I_{th}	Φ_{eth}	< 20	μW
Current above threshold at 25 °C, $\Phi_e = 0.4 \text{ mW}$	ΔI_F	10 ... 35	mA
Current above threshold, $\Phi_e = 0.4 \text{ mW}$	ΔI_F	7 ... 50	mA
Variation of 1st derivative of P/I (0.05 ... 0.4 mW)	dP/dI	– 30 ... 30	%
Differential series resistance	r_S	< 8	Ω
Rise and fall time (10 % - 90 %)	t_r, t_f	< 1	ns
Temperature coefficient of wavelength	TC_λ	< 0.5	nm / K

Characteristics (cont'd)

Parameter	Symbol	Values	Unit
Monitor Diode			
Dark current, $V_R = 2 \text{ V}$, $\Phi_e = 0$, $T_C = 85 \text{ °C}$	I_R	200	nA
Photocurrent, $V_R = 2 \text{ V}$, $\Phi_e = 0.2 \text{ mW}$	I_P	100 ... 1000	μA
Capacitance, $V_R = 2 \text{ V}$, $f = 1 \text{ MHz}$	C_2	< 10	pF
Tracking error, $V_R = 2 \text{ V}$ (see note 1)	TE	- 1 ... 1	dB
Detector			
Dark current, $V_R = 2 \text{ V}$, $\Phi_e = 0$, $T_C = 85 \text{ °C}$	I_R	< 50	nA
Spectral sensitivity, $V_R = 2 \text{ V}$, $\lambda = 1300 \text{ nm}$,	S_λ	> 0.65	A / W
Capacitance, $V_R = 2 \text{ V}$, $f = 1 \text{ MHz}$	C_2	< 1.5	pF
Rise and fall time, $V_R = 2 \text{ V}$, 10 % - 90 %	t_r, t_f	< 1	ns
Module			
Optical crosstalk (see note 2)	CRT	< - 47	dB

Note 1: The tracking error TE is the variation rate of Φ_e at constant current I_{mon} over a specified temperature range and relative to the reference point: $I_{\text{mon,ref}} = I_{\text{mon}}$ ($T = 25 \text{ °C}$, $\Phi_e = 0.2 \text{ mW}$). Thus, TE is given by:

$$TE[\text{dB}] = 10 \times \log \frac{\Phi_e[T_C] - \Phi_e[25 \text{ °C}]}{\Phi_e[25 \text{ °C}]}$$

Note 2: Optical Crosstalk is defined as $CRT = 10 \times \log(I_{\text{Det},0}/I_{\text{Det},1})$ with: $I_{\text{Det},0}$ the photocurrent with $\Phi_e = 0.2 \text{ mW}$ CW laser operation, $V_R = 2 \text{ V}$ and $I_{\text{Det},1}$ the photocurrent without Φ_e , but 0.2 mW optical input power, $\lambda = 1300 \text{ nm}$.

Accompanying Information

$T = 25\text{ °C}$: Threshold current, current above threshold for 0.4 mW output power, monitor current for 0.2 mW output power, peak wavelength.

$T = 85\text{ °C}$: Threshold current, current above threshold for 0.4 mW output power, monitor current for 0.2 mW output power.

End of Life Values

Parameter	Symbol	Values	Unit
Threshold current at $T = 85\text{ °C}$	I_{th}	< 80	mA
Current above threshold, over full temperature range, at $I_{mon,ref} = I_{mon}$ ($T = 25\text{ °C}$, $\Phi_e = 0.4\text{ mW}$, BOL)	ΔI_F	7 ... 70	mA
Tracking error (see note 1)	TE	- 1.5 ... 1.5	dB
Detector dark current, $V_R = 2\text{ V}$, $T = 85\text{ °C}$	I_R	< 400	nA
Monitor dark current, $V_R = 2\text{ V}$, $T = 85\text{ °C}$	I_R	< 1	μA

Fiber Pigtail

Type: single mode, silica

Parameter	Values	Unit
Mode field diameter	9 ± 1	μm
Cladding diameter	125 ± 2	μm
Mode field/cladding concentricity error	< 1	μm
Cladding non-circularity	< 2	%
Mode field non-circularity	< 6	%
Cut-off wavelength	> 1270	nm
Jacket diameter	0.9 ± 0.1	mm
Bending radius	> 30	mm
Tensile strength fiber/case	> 5	N
Length	1 ± 0.2	m

Laser Diode
Radiant Power in Singlemode Fiber

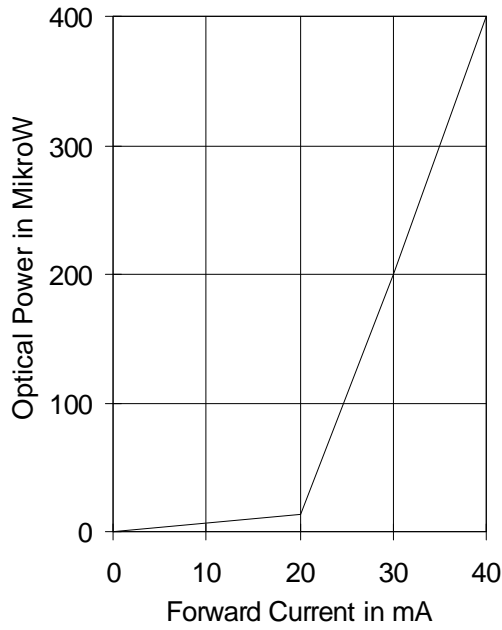

Relative Radiant Power
 $\Phi_e = f(\lambda)$

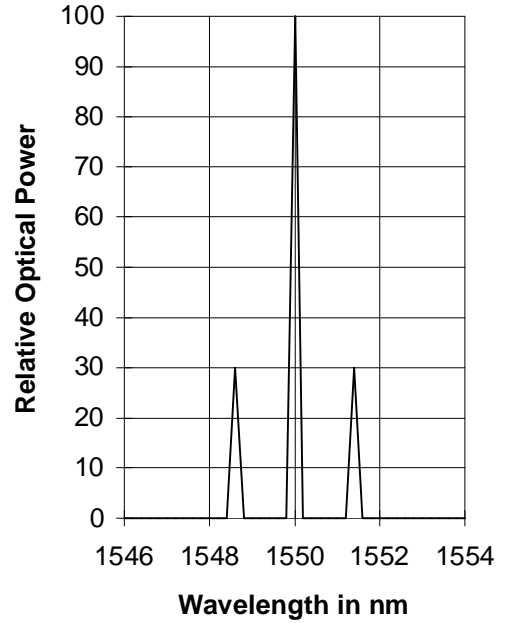

Laser Forward Current
 $I_F = f(V_F)$

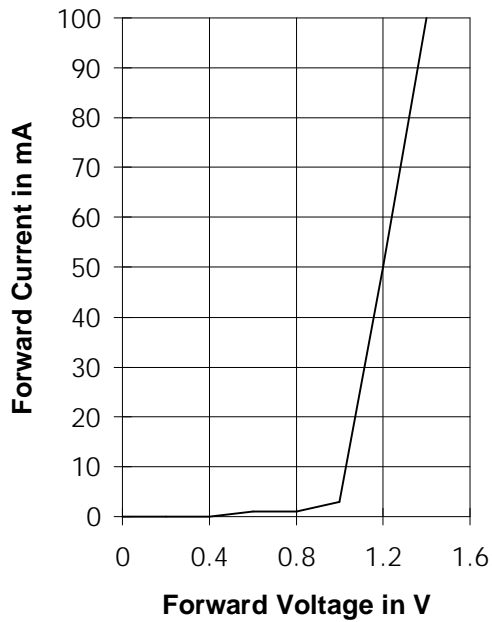

Monitor Diode Dark Current $I_R = f(T_A)$
 $\Phi_{port} = 0, V_R = 5 V$

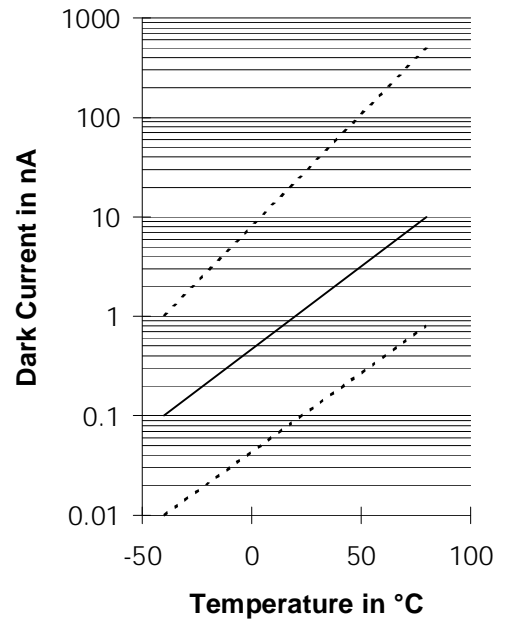

Capacitance of PIN Diode $C = f(V_R)$
 $\Phi_{port} = 0, f = 1 \text{ MHz}$

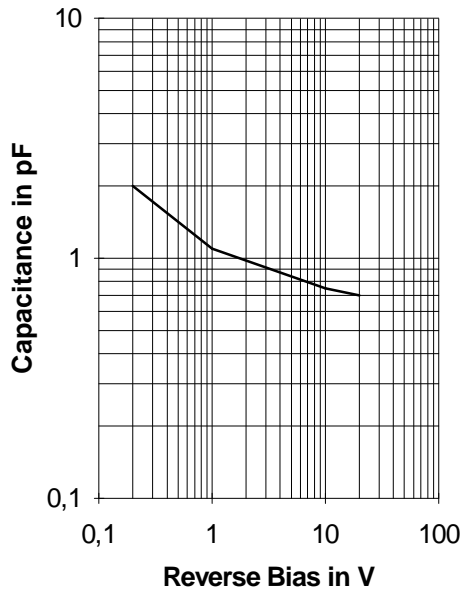

Rel. Spectral Sensitivity of PIN Diode
 $V_R = 5 \text{ V}$

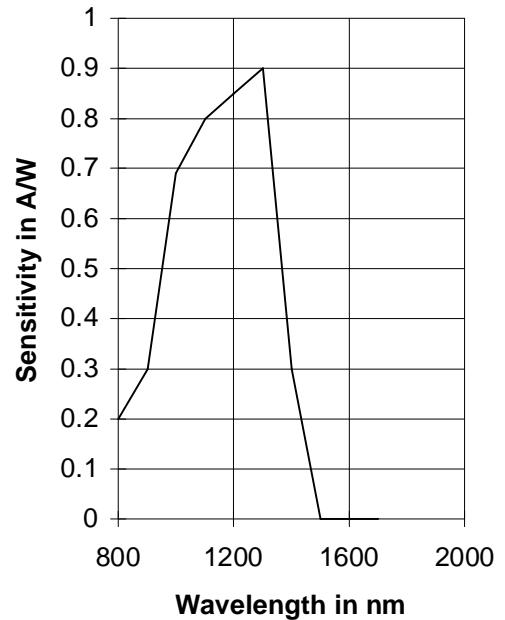

Dark Current of PIN Diode $I_R = f(V_R)$
 $I_F = f(V_F)$

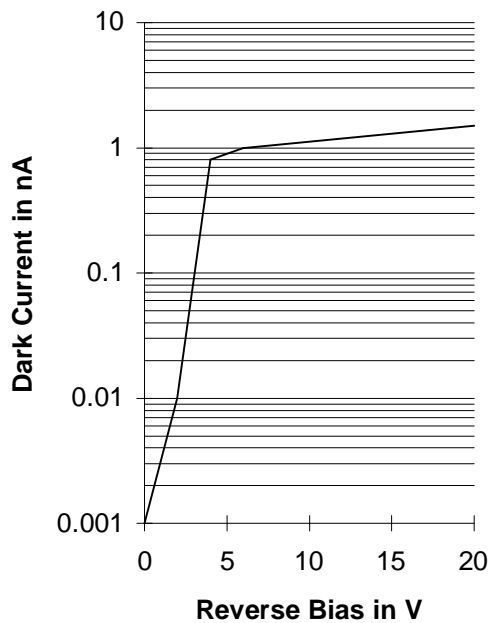

Dark Current of PIN Diode $I_R = f(T_A)$
 $\Phi_{port} = 0, V_R = 5 \text{ V}$

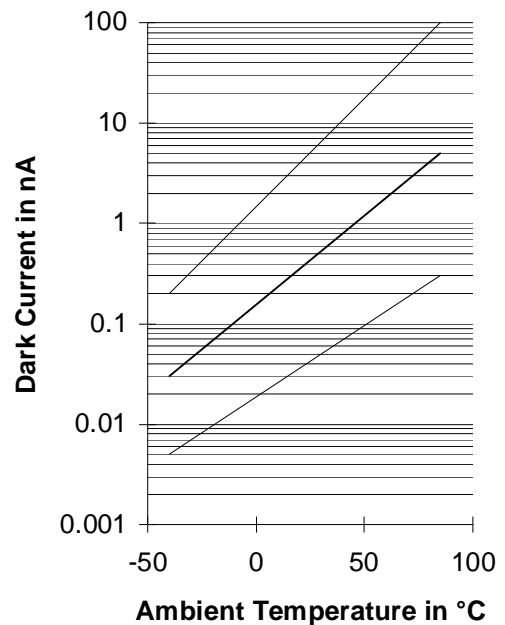

Package Outlines (Dimensions in mm)

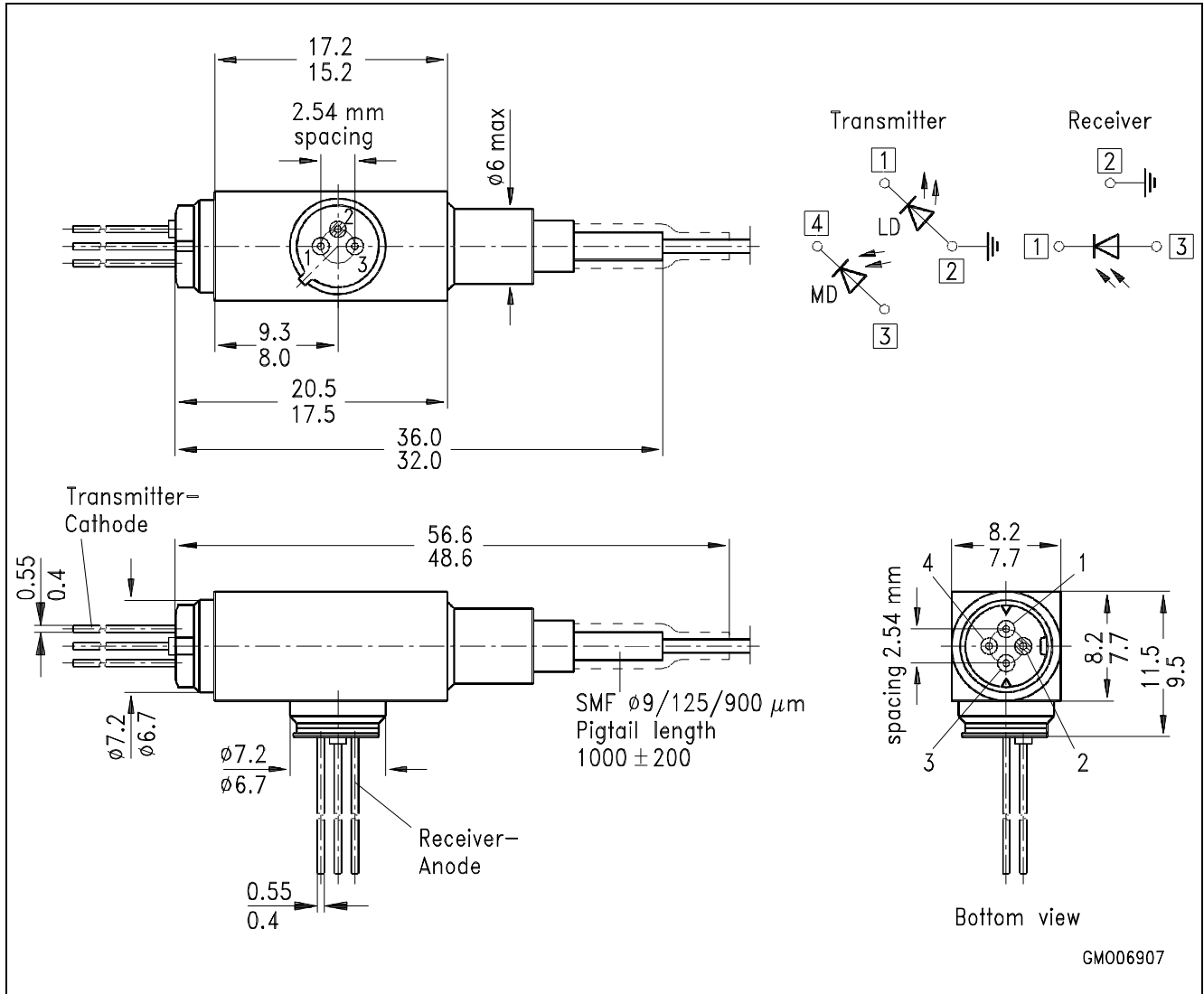

SBL 81314X