

DATA SHEET

SA1920

Dual-band RF front-end

Product specification
Supersedes data of 1998 Apr 07
IC17 Data Handbook

1999 Mar 02

Dual-band RF front-end

SA1920

DESCRIPTION

The SA1920 is an integrated dual-band RF front-end that operates at both cellular (AMPS, GSM and TDMA) and PCS/DCS (TDMA and GSM) frequencies, and is designed in a 13 GHz f_T BiCMOS process—QUBiC1. The low-band is a combined low-noise amplifier (LNA) and mixer. The LNA has a 1.7 dB noise figure at 881 MHz with 17.5 dB of gain and an IIP3 of -5 dBm. The wide-dynamic range mixer has a 10 dB noise figure at 881 MHz with 9.5 dB of gain and an IIP3 of +5 dBm.

The high-band contains a receiver front-end, doubler and a high frequency transmit mixer intended for closed loop transmitters. One advantage of the high-band architecture is an image-rejection mixer with over 30 dB of image rejection; thus, eliminating external filter cost while saving board space. The system noise figure is 4.2 dB at 1960 MHz with a power gain of 23.5 dB and an IIP3 of -12.5 dB.

FEATURES

- Low current consumption
- Outstanding low- and high-band noise figure
- Excellent gain stability versus temperature and supply
- Image reject high-band mixer with over 30 dB of rejection
- Increased low-band LNA gain compression during analog transmission
- LO input and output buffers
- Frequency doubler
- On chip logic for network selection and power down
- Very small outline package

APPLICATIONS

- 800 to 1000 MHz analog and digital receivers
- 1800 to 2000 MHz digital receivers
- Portable radios
- Digital mobile communications equipment

PIN CONFIGURATION

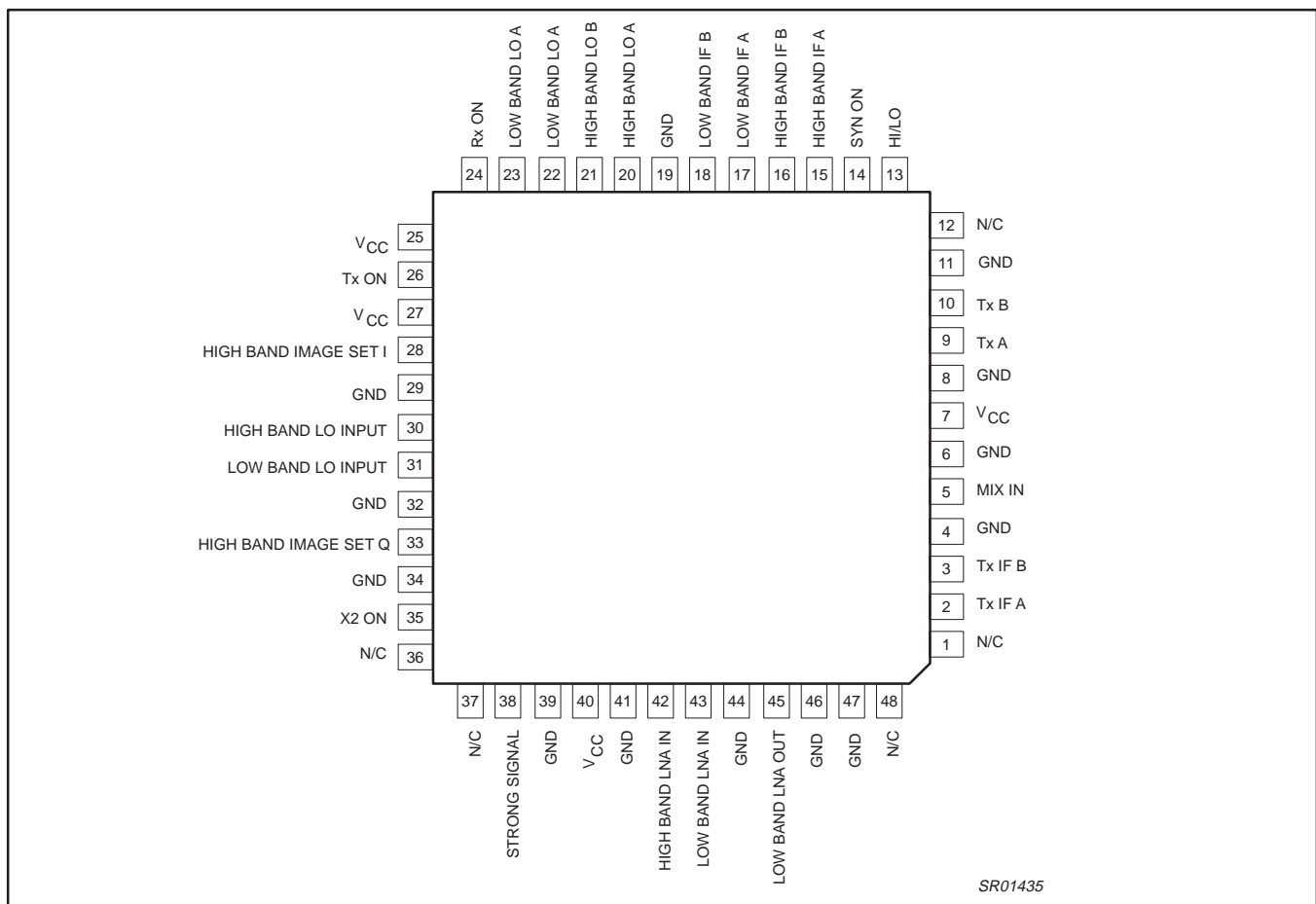

Figure 1. Pin Configuration

ORDERING INFORMATION

TYPE NUMBER	PACKAGE		
	NAME	DESCRIPTION	VERSION
SA1920	LQFP48	Plastic low profile quad flat package; 48 leads; body 7x7x1.4 mm	SOT313-2

Dual-band RF front-end

SA1920

PIN DESCRIPTIONS

PIN NO.	PIN NAME	DESCRIPTION
1	N/C	No Connection
2	Tx IF A	Transmit IF A
3	Tx IF B	Transmit IF B
4	GND	Ground
5	MIX IN	Low Band Mixer Input
6	GND	Ground
7	V _{CC}	V _{CC}
8	GND	Ground
9	Tx A	Transmit Signal A
10	Tx B	Transmit Signal B
11	GND	Ground
12	N/C	No Connection
13	HI/LO	High Band/Low Band Control
14	SYN ON	LO Buffer Power Control
15	HIGH BAND IF A	High Band IF A
16	HIGH BAND IF B	High Band IF B
17	LOW BAND IF A	Low Band IF A
18	LOW BAND IF B	Low Band IF B
19	GND	Ground
20	HIGH BAND LO A	High Band LO Output
21	HIGH BAND LO B	High Band LO Output
22	LOW BAND LO A	Low Band LO Output
23	LOW BAND LO B	Low Band LO Output
24	Rx ON	LNA/Mixer Power Control
25	V _{CC}	V _{CC}
26	Tx ON	Tx Mixer/Driver Power
27	V _{CC}	V _{CC}
28	HIGH BAND IMAGE SET I	High Band Image Set I
29	GND	Ground
30	HIGH BAND LO INPUT	High Band LO Connection
31	LOW BAND LO INPUT	Low Band LO Connection
32	GND	Ground
33	HIGH BAND IMAGE SET Q	High Band Image Set Q
34	GND	Ground
35	X2 ON	Freq. Doubler Power Control
36	N/C	No Connection
37	N/C	No Connection
38	STRONG SIGNAL	Strong Signal Detection
39	GND	Ground
40	V _{CC}	V _{CC}
41	GND	Ground
42	HIGH BAND LNA IN	High Band LNA Input
43	LOW BAND LNA IN	Low Band LNA Input
44	GND	Ground
45	LOW BAND LNA OUT	Low Band LNA Output
46	GND	Ground
47	GND	Ground
48	N/C	No Connection

Dual-band RF front-end

SA1920

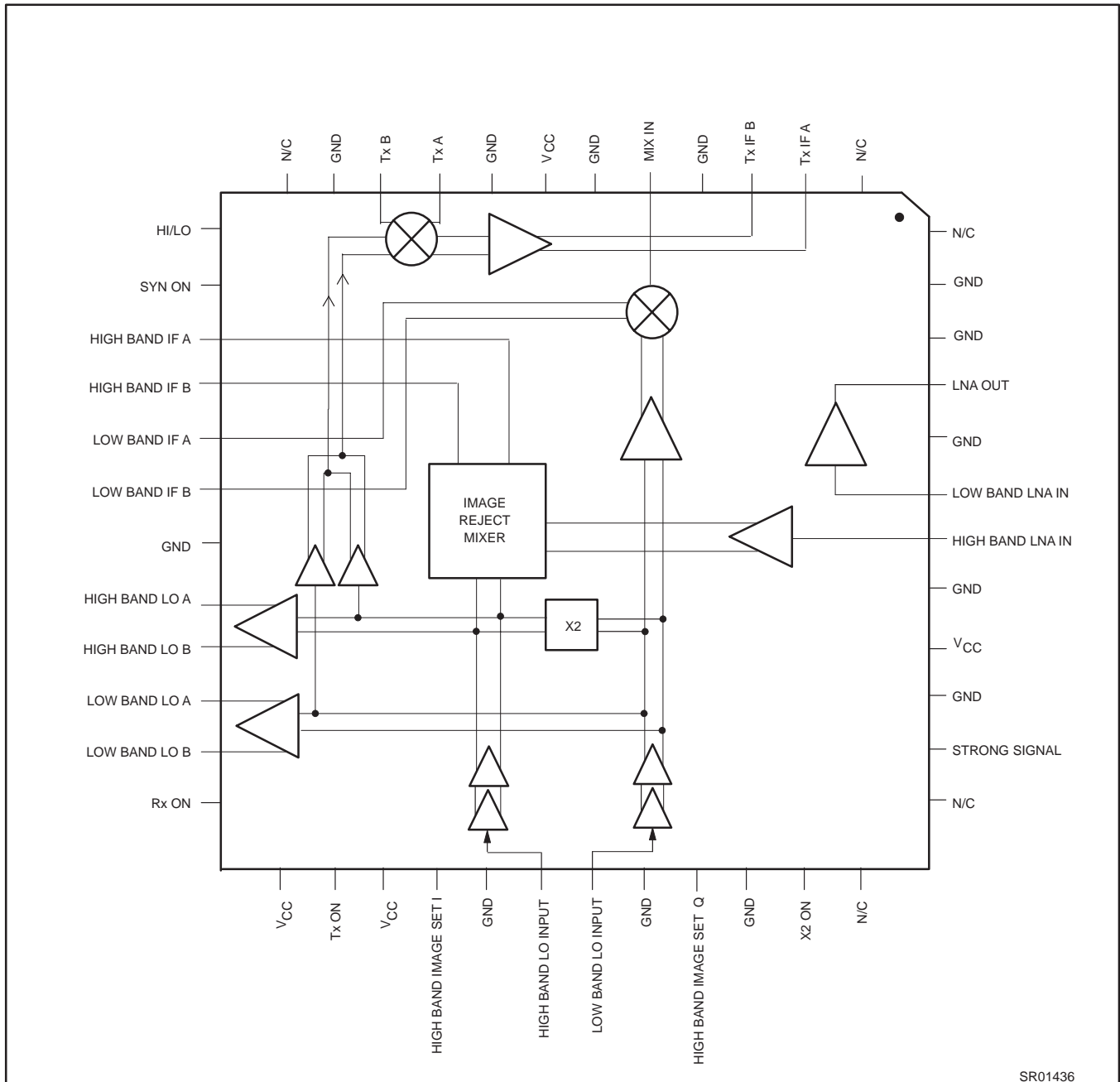

SR01436

Figure 2. Block Diagram

Dual-band RF front-end

SA1920

Table 1. POWER DOWN CONTROL

For Applications Not Using a Frequency Doubler, each state is defined as follows:

		DOUBLER	LO BUFFER		LNA		MIXER		T _X MIXER DRIVER	
Control State (Hi/Lo, Syn On, Rx On, Tx On, Strong Signal, X2 ON)			High Band	Low Band	High Band	Low Band	High Band	Low Band	High Band	Low Band
x000xx	Sleep	Off	Off	Off	Off	Off	Off	Off	Off	Off
010000	Low-Band LO Buffer on	Off	Off	On	Off	Off	Off	Off	Off	Off
011000	Low-Band Receive Normal	Off	Off	On	Off	On	Off	On	Off	Off
011010	Low-Band receive Strong Signal	Off	Off	On	Off	Off	Off	On	Off	Off
011100	Low-Band Transmit (Analog only)	Off	Off	On	Off	On High Bias	Off	On	Off	On
010100	N/A	Off	Off	On	Off	Off	Off	Off	Off	On
110000	High-Band LO Buffer On	Off	On	Off	Off	Off	Off	Off	Off	Off
111000	High-Band Receive Normal	Off	On	Off	On	Off	On	Off	Off	Off
111010	High-Band Receive Strong Signal	Off	On	Off	Off	Off	On	Off	Off	Off
110100	N/A	Off	On	Off	Off	Off	Off	Off	On	Off

For Applications Using a Frequency Doubler, each state is defined as follows:

		DOUBLER	LO BUFFER		LNA		MIXER		T _X MIXER DRIVER	
Control State (Hi/Lo, Syn On, Rx On, Tx On, Strong Signal, X2 ON)			High Band	Low Band	High Band	Low Band	High Band	Low Band	High Band	Low Band
x000xx	Sleep	Off	Off	Off	Off	Off	Off	Off	Off	Off
010000	Transmit (Low and High Band)	Off	Off	On	Off	Off	Off	Off	Off	Off
011000	Low-Band Receive Normal	Off	Off	On	Off	On	Off	On	Off	Off
011010	Low-Band Receive Strong Signal	Off	Off	On	Off	Off	Off	On	Off	Off
011110	Low-Band Transmit (Analog only)	Off	Off	On	Off	On High Bias	Off	On	Off	Off
010100	Low-Band Transmit (GSM)	Off	Off	On	Off	Off	Off	Off	Off	On
010001	Transmit (Low and High Band)	On	Off	On	Off	Off	Off	Off	Off	Off
011001	Low-Band Receive Normal	On	Off	On	Off	On	Off	On	Off	Off
011011	Low-Band Receive Strong Signal	On	Off	On	Off	Off	Off	On	Off	Off
011111	Low-Band Transmit(Analog only)	On	Off	On	Off	On High Bias	Off	On	Off	Off
111001	High-Band Receive Normal	On	On	On	On	Off	On	Off	Off	Off
111011	High-Band Receive Strong Signal	On	On	On	Off	Off	On	Off	Off	Off
110101	High-Band Transmit (GSM)	On	On	On	Off	Off	Off	Off	On	Off

NOTE:

“0” is low logic state; “1” is high logic state.

Dual-band RF front-end

SA1920

OPERATION

The low-band contains both an LNA and mixer that is designed to operate in the 800 to 1000 MHz frequency range. The high-band contains an LNA and image-rejection mixer that is designed to operate in the 1800 to 2000 MHz frequency range with over 30 dB of rejection over an intermediate frequency (IF) range from 100 to 125 MHz.

Image rejection is achieved in the internal architecture by two RF mixers in quadrature and two all-pass filters in the I and Q IF channels that phase shift the IF by 45° and 135° , respectively. The two phase shifted IFs are recombined and buffered to produce the IF output signal.

The LO section consists of an internal all-pass type phase shifter to provide quadrature LO signals to the receive mixers. The all-pass filters outputs are buffered before being fed to the receive mixers. The transmit mixer section consists of a low-noise amplifier, and a down-convert mixer. In the transmit mode, an internal LO buffer is used to drive the transmit IF down-convert mixer.

Low-Band Receive Section

The circuit contains a LNA followed by a wide-band mixer. In a typical application circuit, the LNA output uses an external pull-up inductor to V_{CC} and is AC coupled. The mixer IF outputs are differential. A typical application will load the output buffer with an inductor across the IF outputs, a pull-up inductor to V_{CC} and an AC coupled capacitor to the matching network.

Low-Band Receive Section (Analog Transmit Mode)

The bias current of the low-band LNA will increase during analog transmission, which increases its gain compression point and makes the receiver less sensitive to PA leakage power for an AMPS application.

High-Band Receive Section

The circuit contains an LNA followed by two high dynamic range mixers. These are Gilbert cell mixers; the internal architecture is fully differential. The LO is shifted in phase by 45° and 135° and mixes the amplified RF signal to create I and Q channels. The two I and Q channels are buffered, phase shifted by 45° and 135° , respectively, amplified and recombined internally to realize the image rejection.

The IF output is differential and of the open-collector type. A typical application will load the output buffer with an inductor across the IF outputs, a pull-up inductor to V_{CC} and an AC coupled capacitor to the matching network.

Control Logic Section

Pins HI/LO, SYN ON, Rx On, Tx On, Strong Signal, X2 (doubler) On, control the logic functions. The HI/LO mode selects between low-band and high-band operation. The SYN ON mode enables the LO buffers independent of the other circuitry. When SYN ON is high, all internal buffers in the LO path of the circuit are turned on, thus minimizing LO pulling when the remainder of the receive or transmit chain is powered-up.

The Rx ON mode enables the LO buffers when the device is in the low-band receive normal, receive strong signal and transmit modes; the Rx ON mode enables the LO buffers, also, when the device is in the high-band receive normal, and receive strong signal modes.

The Tx ON mode enables the transmit mixer. The strong signal mode, when disabled, allows the low- and high-band LNAs to function normally; and when the strong signal mode is enabled, it turns-off the low- and high-band LNAs. This is needed when the input signal is large and needs to be attenuated.

The doubler (X2) on mode enables the doubler. When the doubler is on, the input signal from the LO buffers is doubled in frequency. The signal can be used to drive the image-rejection mixer and the output LO high-band ports. When the doubler mode is on, all other control logic (see table 1) functions the same.

Local Oscillator (LO) Section

The LO input directly drives the two internal all-pass networks to provide quadrature LO to the receive mixers. A synthesizer-on (SYN ON) mode is used to power-up all LO input buffers, thus minimizing the pulling effect on the external VCO when entering receive or transmit mode.

Transmit Mixer Section

The transmit mixer is used for down-conversion to the transmit IF. Its inputs are coupled to the transmit RF which is down-converted to a modulated transmit IF frequency, and phase-locked with the baseband modulation.

The IF outputs are HIGH impedance (open-collector type). A typical application will load the output buffer with an inductor across the IF outputs, a pull-up inductor to V_{CC} and AC coupled capacitors to the matching network.

Dual-band RF front-end

SA1920

ABSOLUTE MAXIMUM RATINGS

QUANTITY	SYMBOL	VALUE	UNIT
Input supply voltage at pins: 7, 25, 27, 40	V_{CC}	4.75	V
Power dissipation	P_D	150	mW
Input power at all ports	P_{IN}	+20	dBm
Operating temperature range (pin temp)	T_O	-40 to+85	°C
Storage temperature range	T_{srg}	-65 to +125	°C

DC ELECTRICAL CHARACTERISTICS

Unless otherwise specified, all Input/Output ports are single-ended.

DC PARAMETERS

$V_{CC} = +3.75$ V, $T_A = -40$ to $+85$ °C unless otherwise noted

QUANTITY	CONDITION	SYMBOL	MIN.	TYP.	MAX.	UNIT
DC Supply voltage		V_{CC}	3.6	3.75	3.9	V
Current Consumption: Sleep Mode	X000XX	I_{CC}		1	100	μA
Low Band Receive Normal	011000	I_{CC}	10.1	12.5	15.2	mA
Low Band Receive Strong	011010	I_{CC}		8.8		mA
Low Band Transmit (Analog)	011110	I_{CC}		18.0		mA
Low Band Transmit (GSM)	010100	I_{CC}		16.0		mA
High Band Receive Normal	111000	I_{CC}	35.0	42.0	53.0	mA
High Band Receive Strong	111010	I_{CC}		38.0		mA
High Band Transmit (GSM)	110100	I_{CC}		21.5		mA
Frequency Doubler				8.8		mA
Logic Low Input			0		0.5	V
Logic High Input			1.9		4.0	V

Dual-band RF front-end

SA1920

AC ELECTRICAL CHARACTERISTICS**Low-Band, Dual Mode of Operation** $V_{CC} = +3.75\text{ V}$, $F_{req_{RF}} = 881\text{ MHz}$, $F_{req_{LO}} = 991.52\text{ MHz}$, $P_{in} = -3\text{ dBm}$, $T_A = +25^\circ\text{C}$; unless otherwise stated

PARAMETERS	Min	-3 σ	TYP	+3 σ	Max	UNITS	NOTES
System							
RF Input Frequency Range	869		881		960	MHz	
IF Frequency			110.52			MHz	
LO Frequency			991.52			MHz	
Cascaded Power Gain; includes 3dB filter loss	22.5		24		25.5	dB	
Power Gain Reduction (Strong Signal Mode—LNA Off)	29		35		41	dB	
Cascaded Noise Figure; includes 3dB filter loss			2.6			dB	
LNA							
LNA Gain		17	17.5	18		dB	
LNA IIP3		-6	-5	-4		dBm	
LNA Noise Figure		1.6	1.7	1.8		dB	
Mixer							
Mixer Gain		9	9.5	10		dB	
Mixer IIP3		4	5	6		dBm	
Mixer Noise Figure		9	10	11		dB	
Other							
Input Impedance, RF Port			50			Ω	
Return Loss at LNA Inputs and Output					-10	dB	1
Return Loss at Mixer Input and Outputs					-10	dB	1
LO leakage at RF Port			-42			dBm	
LO Input Power	-5		-3		-1	dBm	
Turn ON/OFF Time			100			μsec	

Low-Band LO Buffer

PARAMETERS	Min	-3 σ	TYP.	+3 σ	Max	UNITS	NOTES
LO Frequency			991.52			MHz	
Differential Output Power			-7			dBm	
Differential Output Impedance			100			Ω	
Harmonic Content			-20			dBc	
Input Power	-5		-3		-1	dBm	
Input Impedance			50			Ω	1
Turn On/Off Time			30			μsec	

Dual-band RF front-end

SA1920

AC ELECTRICAL CHARACTERISTICS

High-Band, Single Mode of Operation
LNA and Image Reject Mixer $V_{CC} = +3.75$ V, $Freq_{RF} = 1960$ MHz, $Freq_{LO} = 2070.52$ MHz, $P_{in} = -3$ dBm, $T_A = +25^\circ$ C; unless otherwise stated

PARAMETERS	MIN	-3σ	TYP.	$+3\sigma$	MAX	UNITS	NOTES
RF Input Frequency Range	1805				1990	MHz	
IF Frequency	100		110.52		125	MHz	
LO Frequency	1905				2115	MHz	
Power Gain	21		23.5		25	dB	
Power Gain Reduction (Strong Signal Mode—LNA Off)	40		47		54	dB	
Noise Figure		4.0	4.2	4.4		dB	
Input Impedance, RF Port			50			Ω	
Return Loss at Inputs					-10	dB	1
LO leakage at RF Port			-48			dBm	
1 dB RF Input Compression Point			-24			dBm	
IP3 (3 RD Order Intermodulation Product) Referred to the RF Input Port		-15	-12.5	-10		dBm	
(2 x LO) – (2 x RF) Spur Performance -50 dBm IN Referred to RF Input Port Measure at LO = 2040 MHz and RF = 1985 MHz			-65			dBc	
(3 x LO) – (3 x RF) Spur Performance. -50 dBm IN Referred to RF Input Port. Measure at LO = 2040 MHz and RF = 2003 MHz.			-62.5			dBc	
Image rejection, $f_{RX}+2f_{IF}$ or $f_{RX}-2f_{IF}$ Referred to the RF Input Port	30		35			dB	
LO Input Power	-5		-3		-1	dBm	
Turn ON/OFF Time			30			μ sec	

High-Band LO Buffer

PARAMETERS	MIN	-3σ	TYP.	$+3\sigma$	MAX	UNITS	NOTES
LO Frequency Range	1905				2115	MHz	
Differential Output Power			-9			dBm	
Differential Output Impedance			100			Ω	
Harmonic Content					-20	dBc	
Input Power	-5		-3		-1	dBm	
Input Impedance			50			Ω	1
Turn On/Off Time			30			μ sec	

Dual-band RF front-end

SA1920

Frequency Doubler

PARAMETERS	MIN	-3 σ	TYP.	+3 σ	MAX	UNITS	NOTES
Output Frequency Range	1905				2115	MHz	
Output Power			-9			dBm	
Differential Output Impedance			100			Ω	
Harmonic Content (3F, 4F, etc.)			-20			dBc	
Subharmonic Content (F_i)			-20			dBc	
Non-Harmonic Content			80			dBc	
Turn On/Off Time			30			μ sec	
Phase Noise Degradation, $\Delta f = 30$ kHz			6			dB	

Transmit Mixer

PARAMETERS	MIN	-3 σ	TYP.	+3 σ	MAX	UNITS	NOTES
T _X Mixer Input Frequency	824				1910	MHz	
T _X RF Input Impedance, Balanced			200			Ω	
T _X Mixer Output Frequency	70				200	MHz	
T _X IF Load Impedance			1000			Ω	
Maximum T _X IF Load Capacitance					2	pF	
Conversion Power Gain		15	16	17		dB	2
1 dB Input Compression Point			-17			dBm	
IIP2			20			dBm	
IIP3		-9	-7	-5		dBm	
Noise Figure (double sideband)			7.5			dB	
Reverse Isolation T _{XIN} -L _{OIN}	40					dB	
Isolation L _{OIN} -T _{XIN}	40					dB	

NOTES:

- External matching network is required.
- From 200 Ω input to a 1k Ω output.

Dual-band RF front-end

SA1920

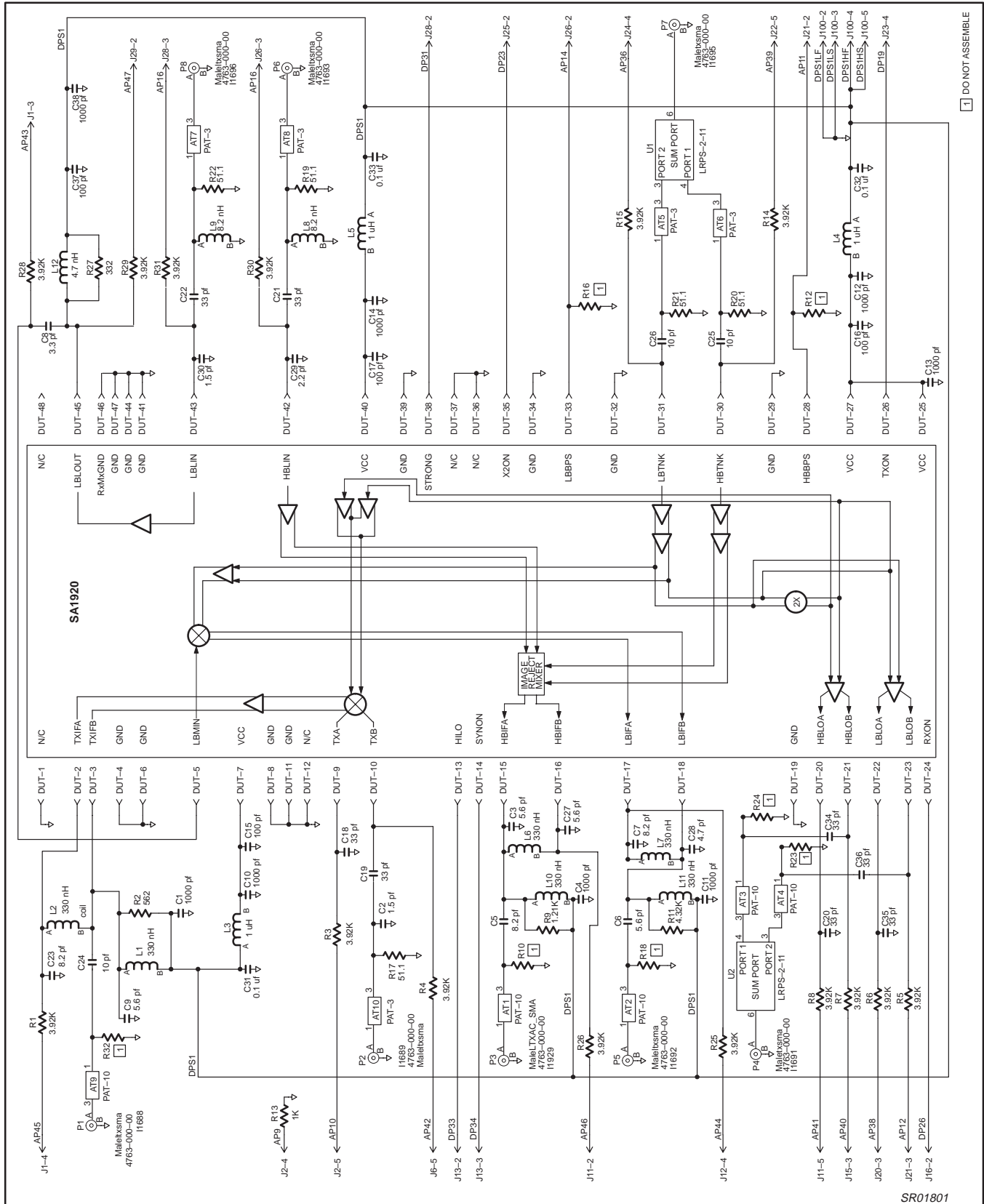

Figure 3. SA1920 Dual-Band Test Circuit

Dual-band RF front-end

SA1920

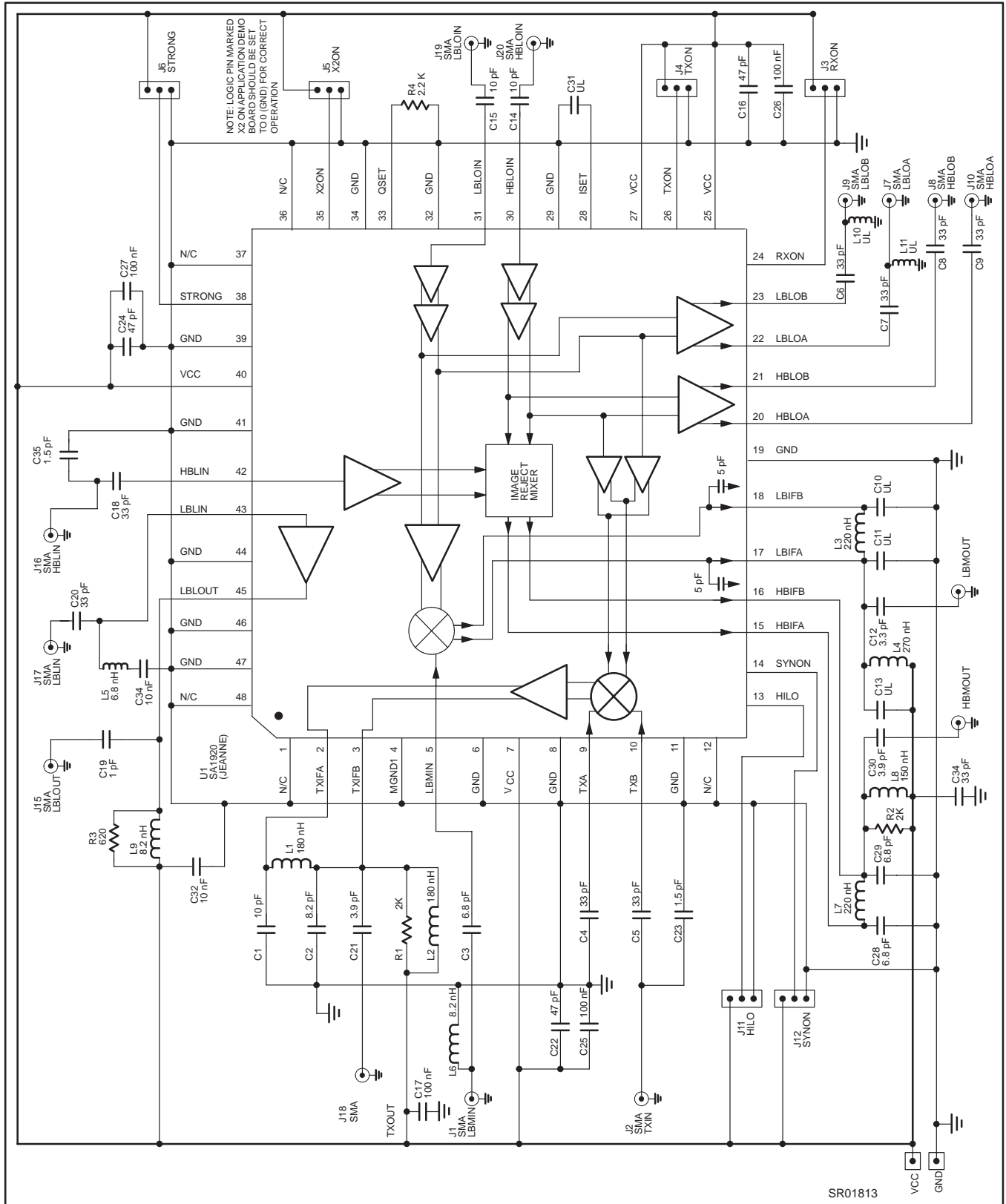

Figure 4. SA1920 Dual-Band Application Circuit

Dual-band RF front-end

SA1920

PERFORMANCE CHARACTERISTICS

$V_{CC} = +3.75$ V, $Freq_{RF} = 1960$ MHz, $Freq_{LO} = 2070.52$ MHz, $P_{in} = -5$ dBm, $T_A = +25^\circ\text{C}$; unless otherwise stated

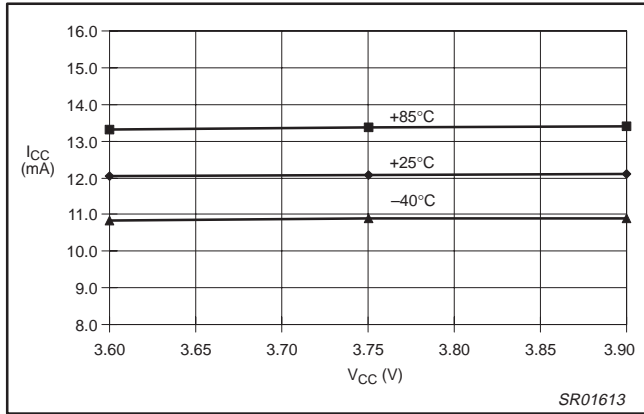

Figure 5. Low Band Receive Normal ICC

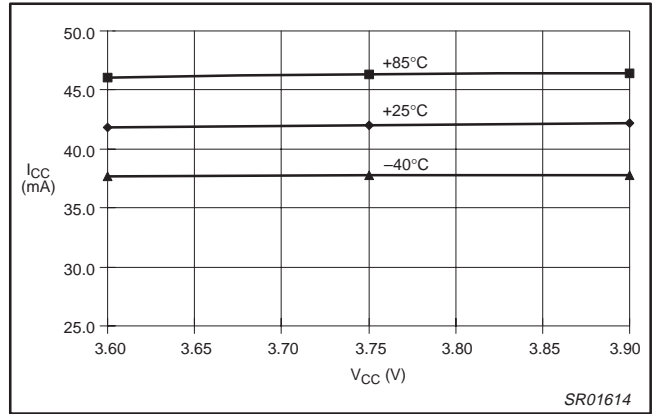

Figure 6. High Band Receive Normal ICC

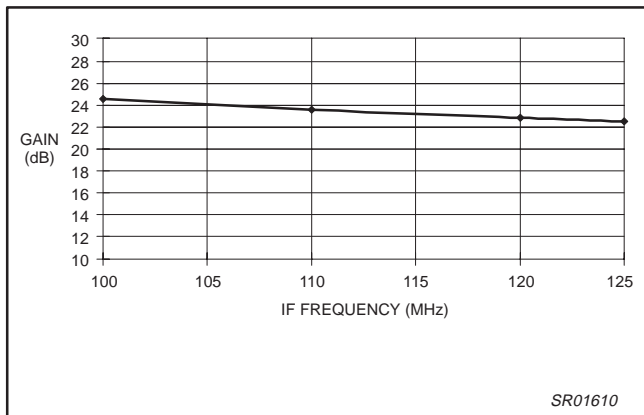

Figure 7. High Band Gain vs. IF Frequency

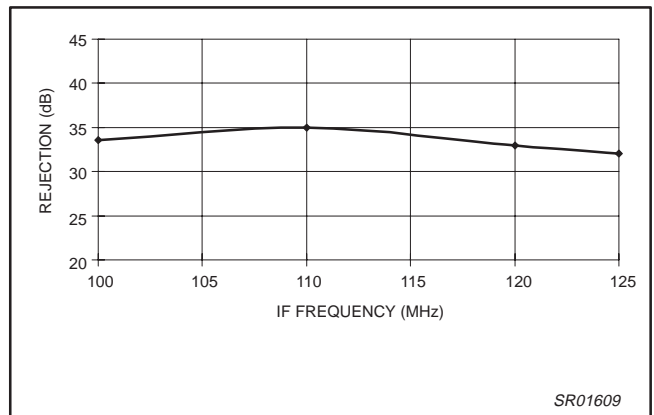

Figure 8. High Band Image Rejection vs. IF Frequency

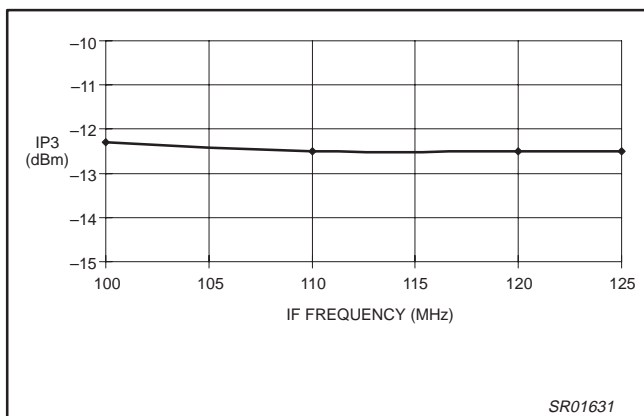

Figure 9. High Band IP3 vs. IF Frequency

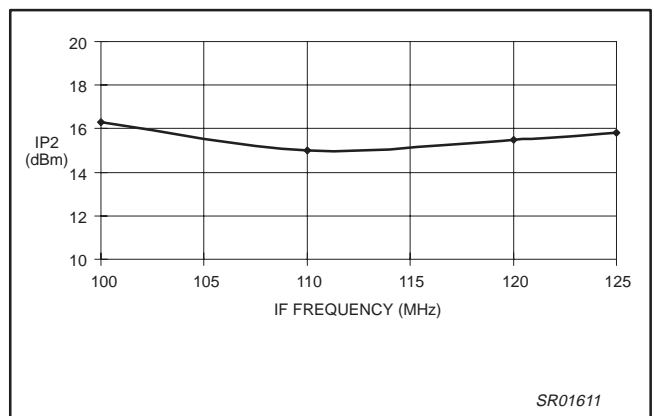

Figure 10. High Band IP2 vs. IF Frequency

Dual-band RF front-end

SA1920

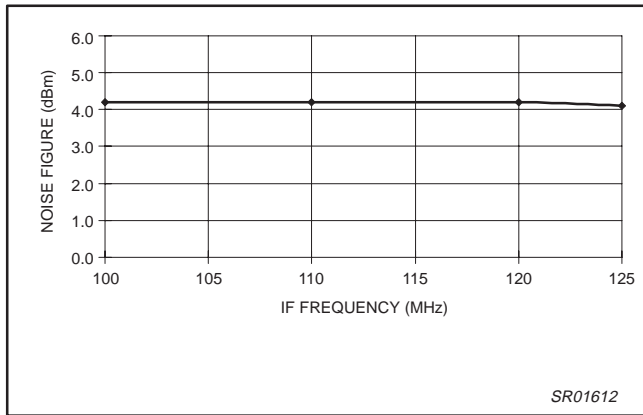

Figure 11. High Band NF vs. IF Frequency

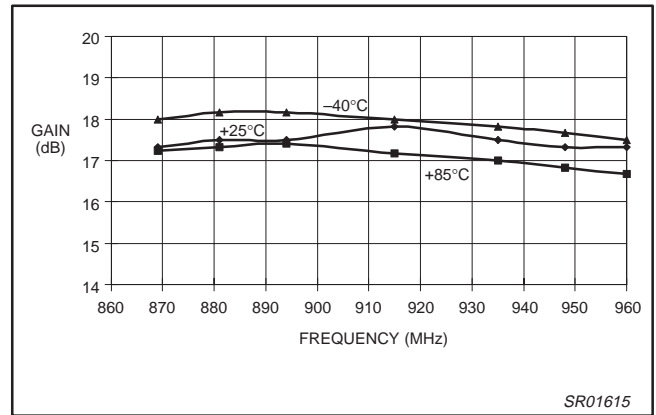

Figure 12. LB LNA Gain vs. Frequency

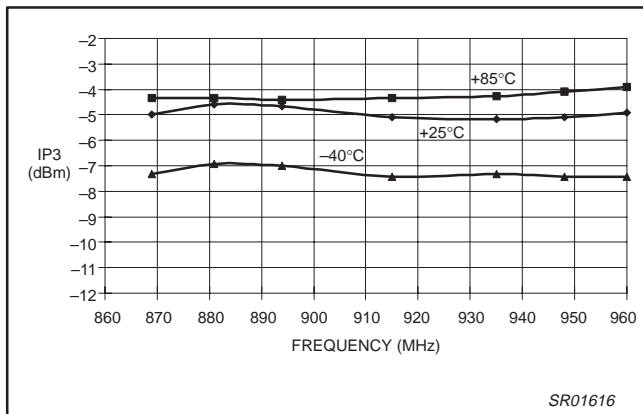

Figure 13. LB LNA IP3 vs. Frequency

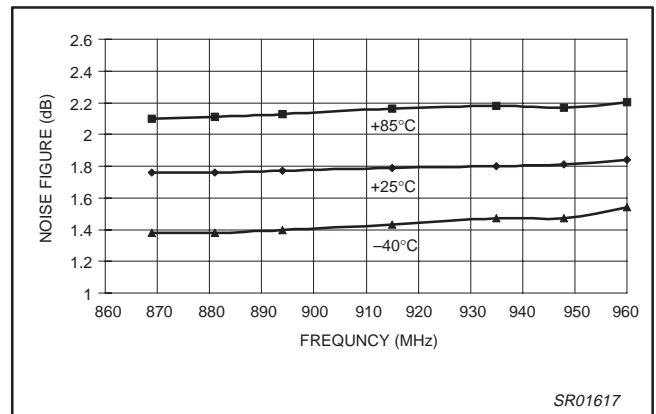

Figure 14. LB LNA Noise Figure vs. Frequency

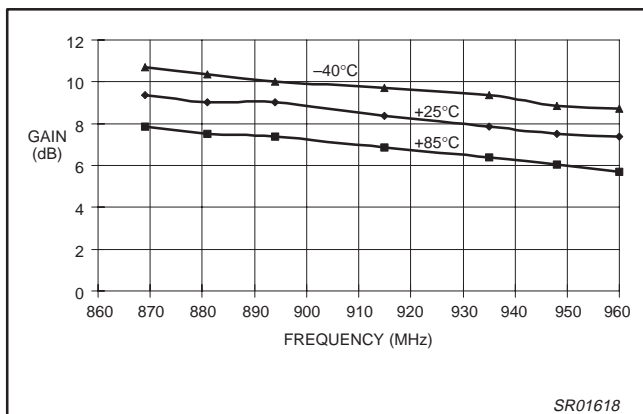

Figure 15. LB Mixer Gain vs. Frequency

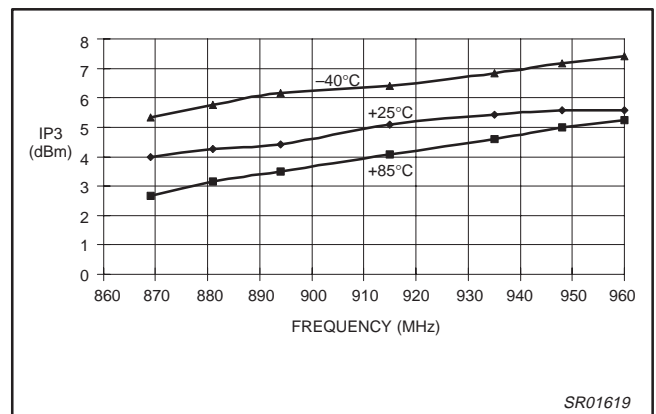

Figure 16. LB Mixer IP3 vs. Frequency

Dual-band RF front-end

SA1920

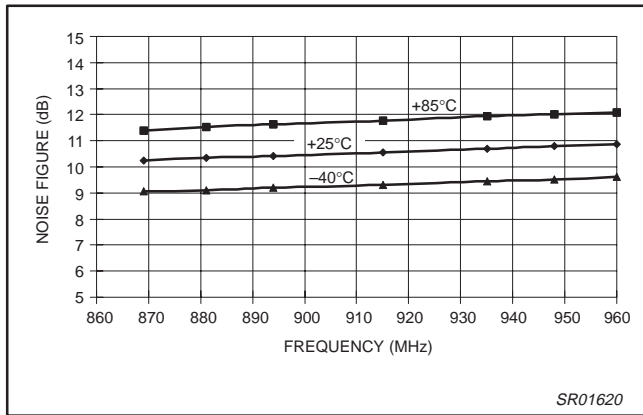

Figure 17. LB Mixer Noise Figure vs. Frequency

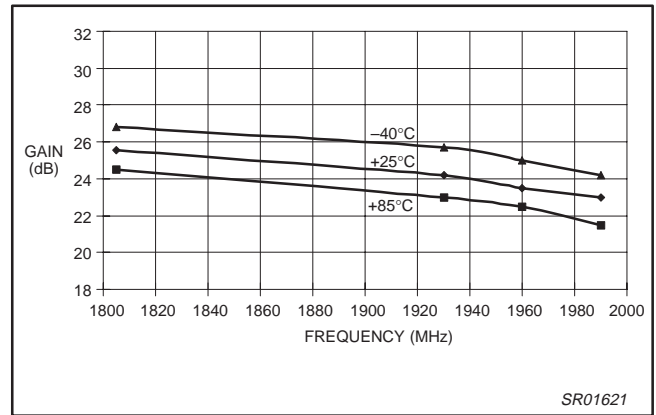

Figure 18. HB Gain vs. Frequency

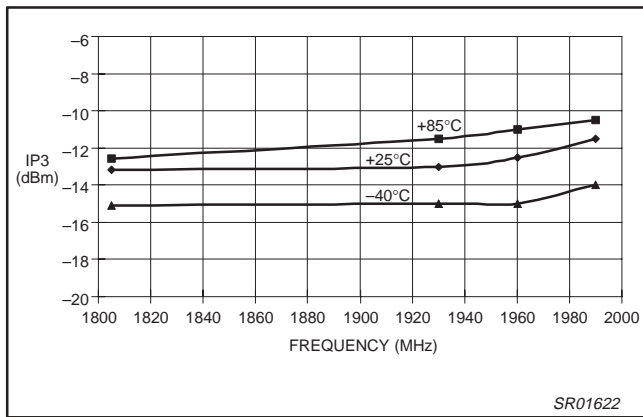

Figure 19. HB IP3 vs. Frequency

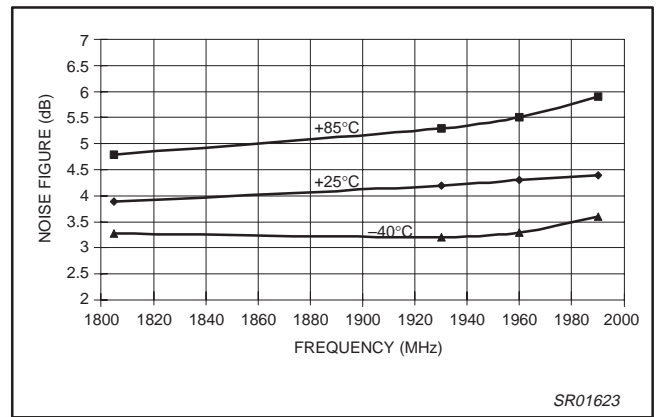

Figure 20. HB Noise Figure vs. Frequency

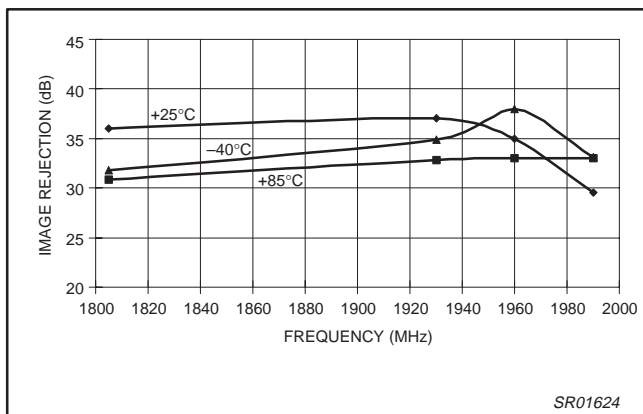

Figure 21. HB Image Rejection vs. Frequency

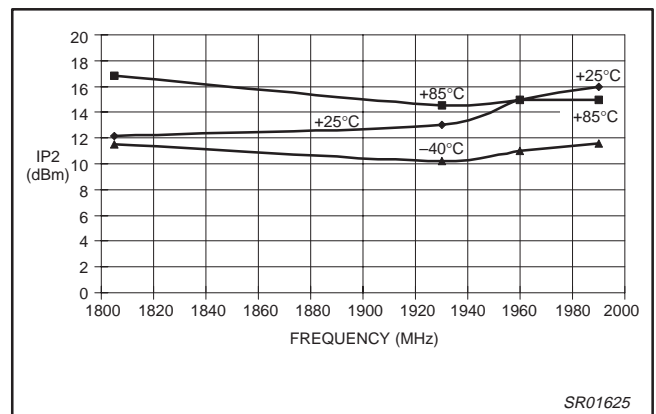

Figure 22. HB IP2 vs. Frequency

Dual-band RF front-end

SA1920

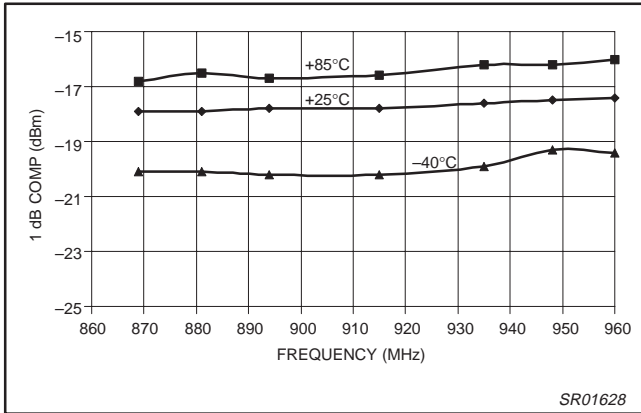

Figure 23. LB LNA 1 dB Compression vs. Frequency

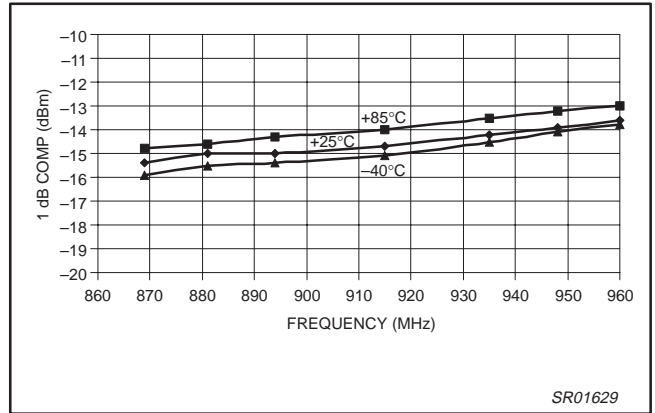

Figure 24. LB Mixer 1 dB Compression vs. Frequency

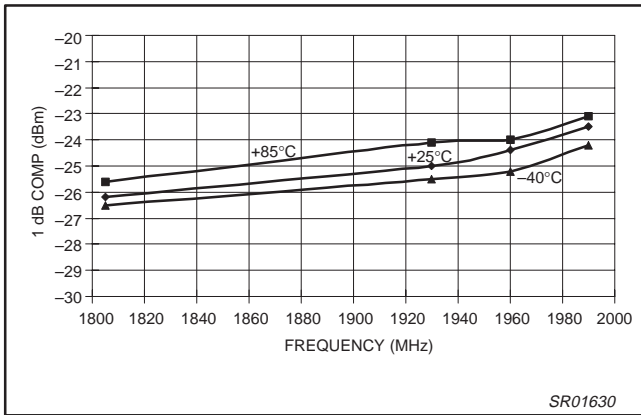

Figure 25. HB 1 dB Compression vs. Frequency

Dual-band RF front-end

SA1920

S-PARAMETERS

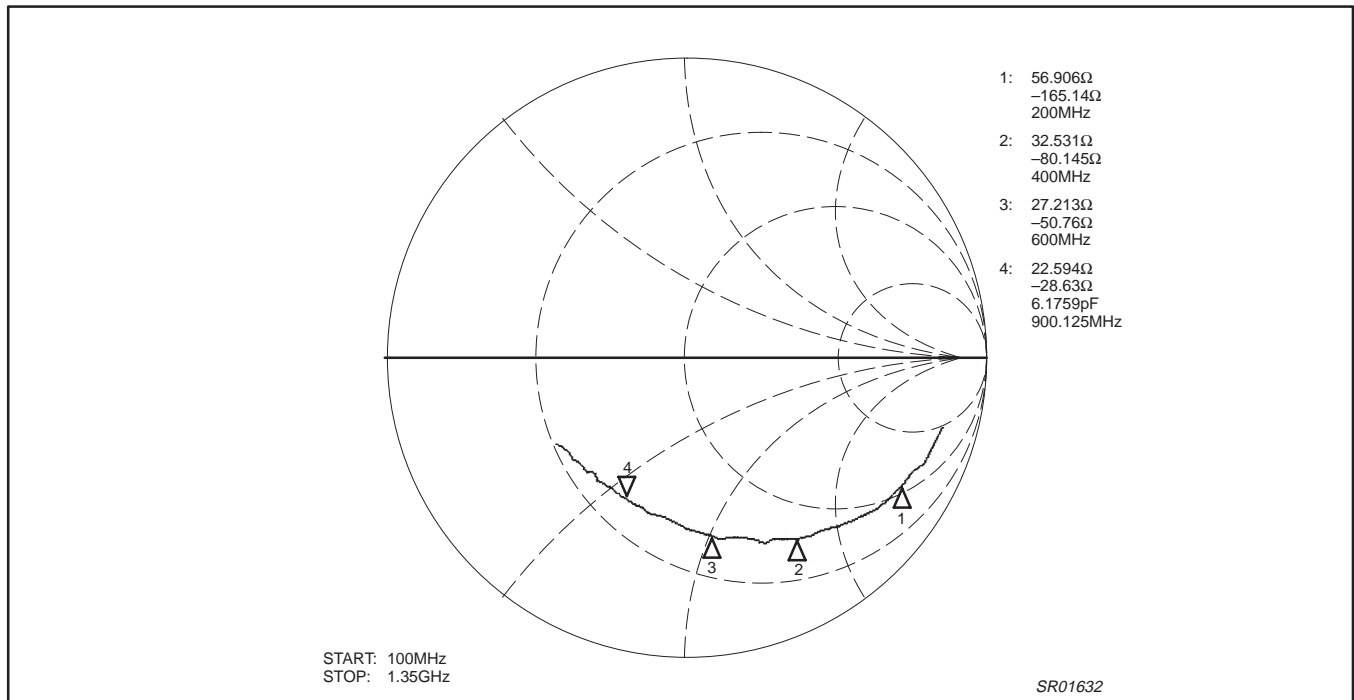

Figure 26. Typical S_{11} of the Low Band LNA at 3.75 V for the Low Band Receive Normal Mode

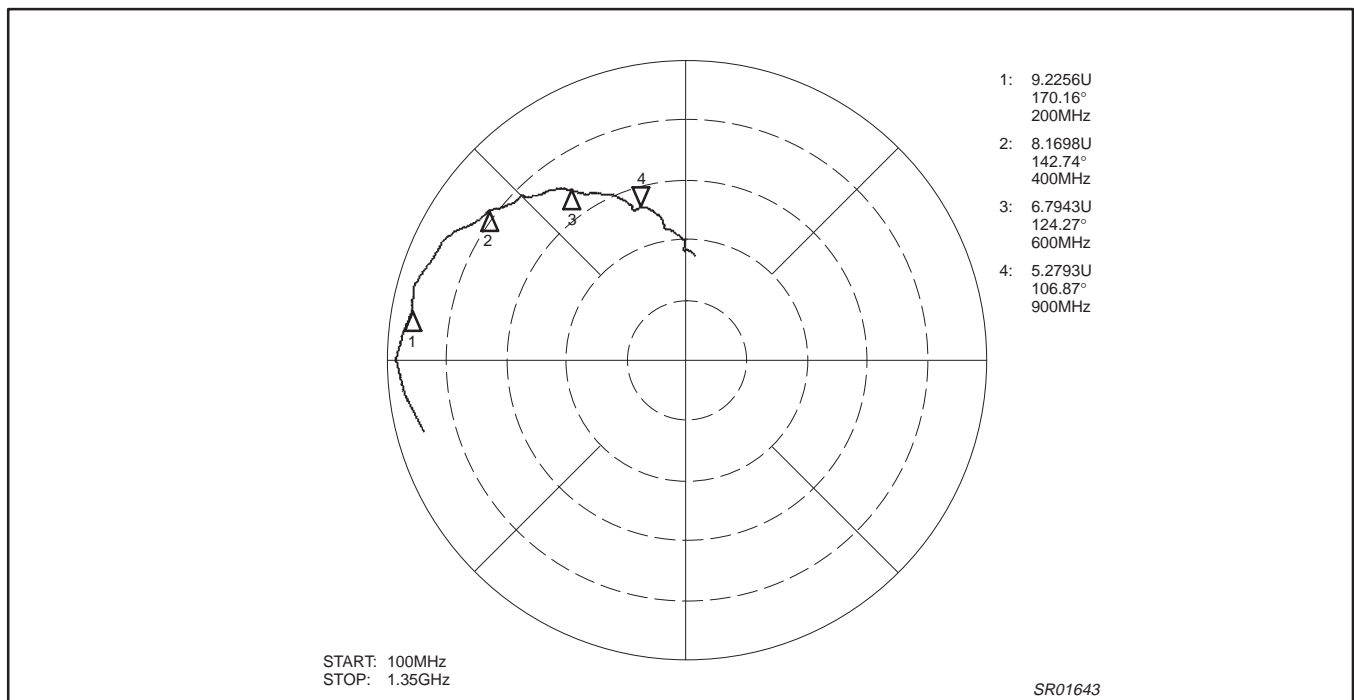

Figure 27. Typical S_{21} of the Low Band LNA @ 3.75V for the Low Band Receive Normal Mode

Dual-band RF front-end

SA1920

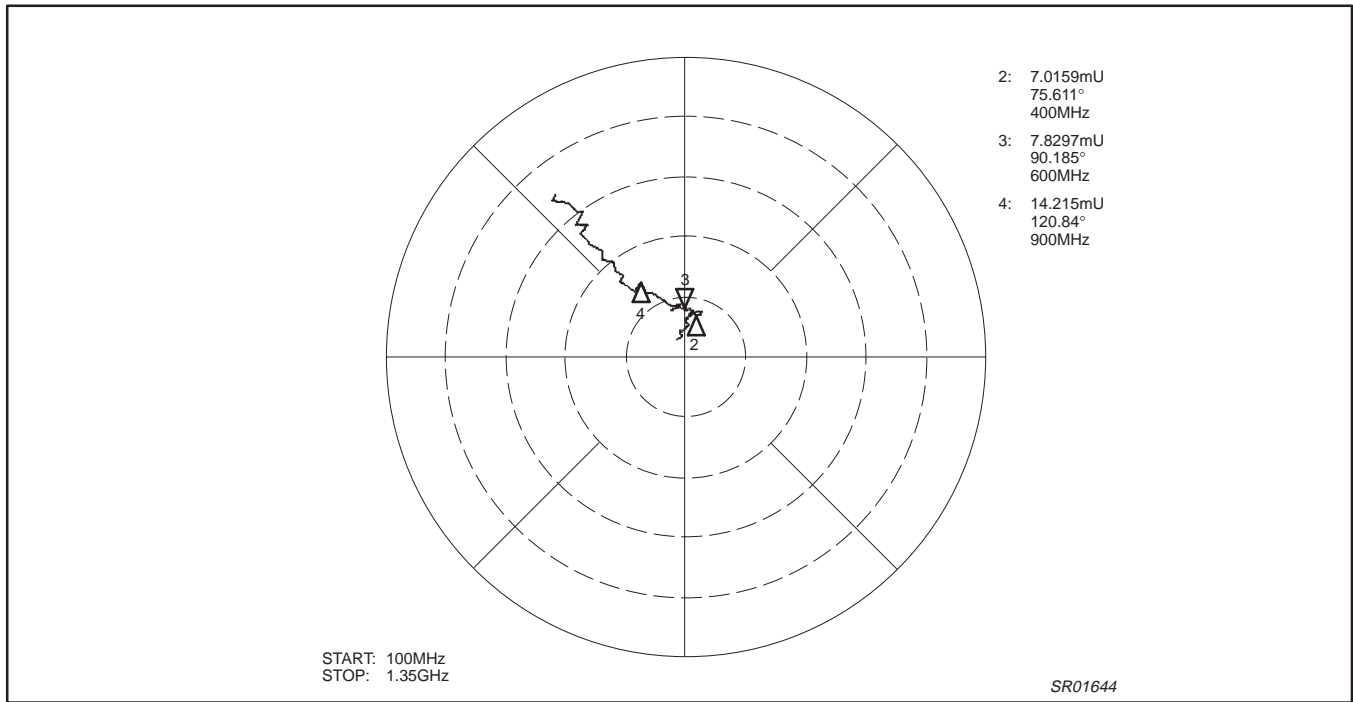

Figure 28. Typical S_{12} of the Low Band LNA @ 3.75V for the Low Band Receive Normal Mode

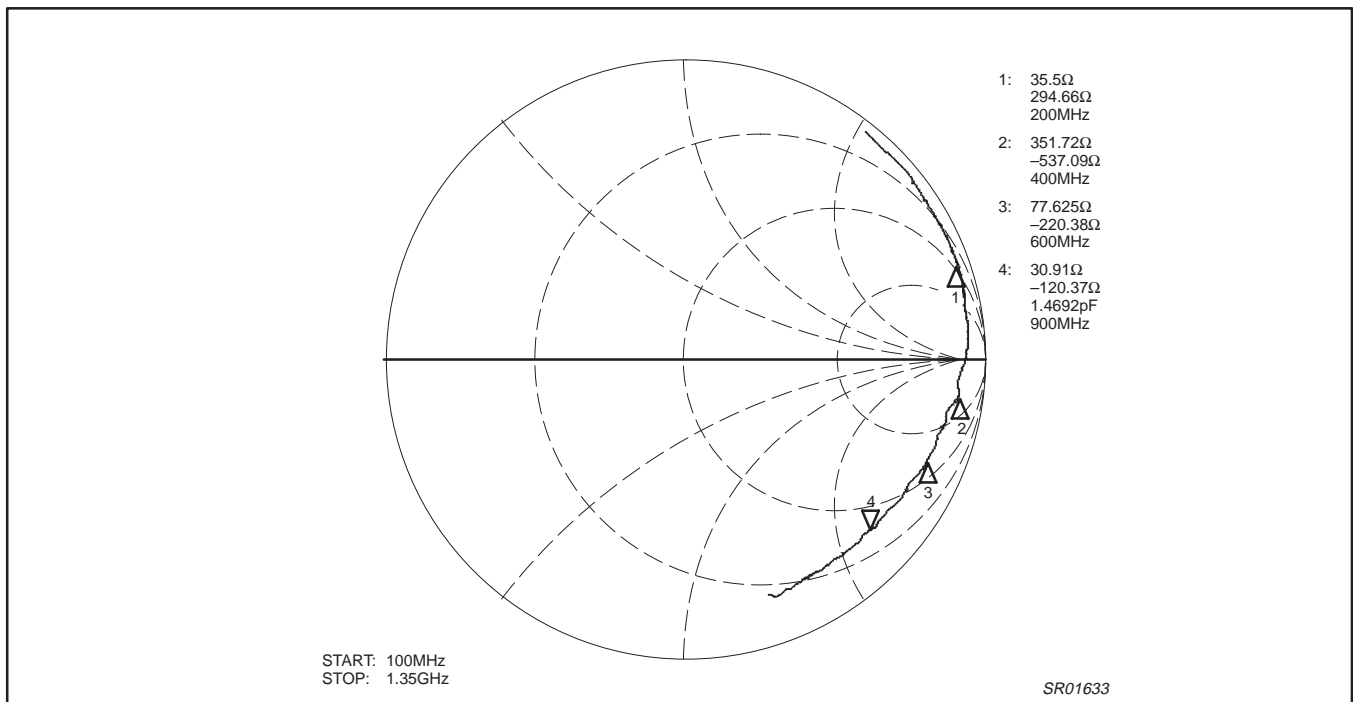

Figure 29. Typical S_{22} of the Low Band LNA @ 3.75V for the Low Band Receive Normal Mode

Dual-band RF front-end

SA1920

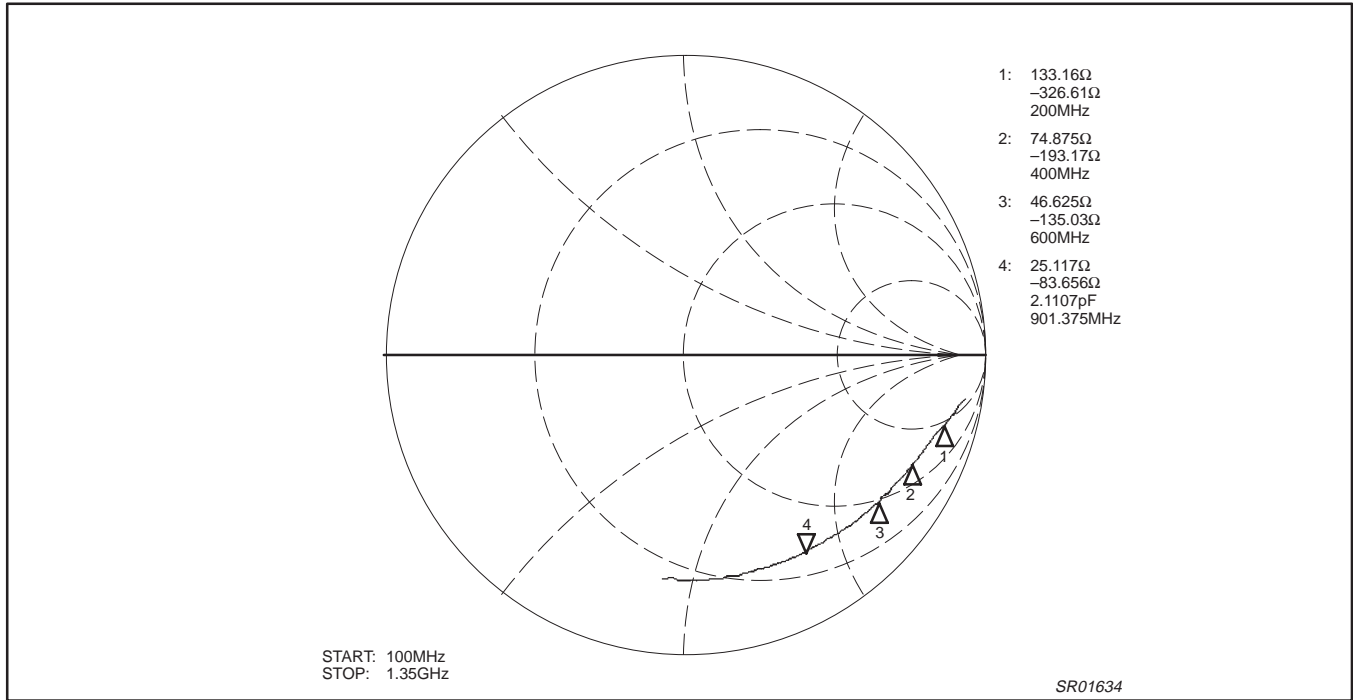

Figure 30. Typical S_{11} of Low Band LNA @ 3.75V for Receive Strong Signal Mode

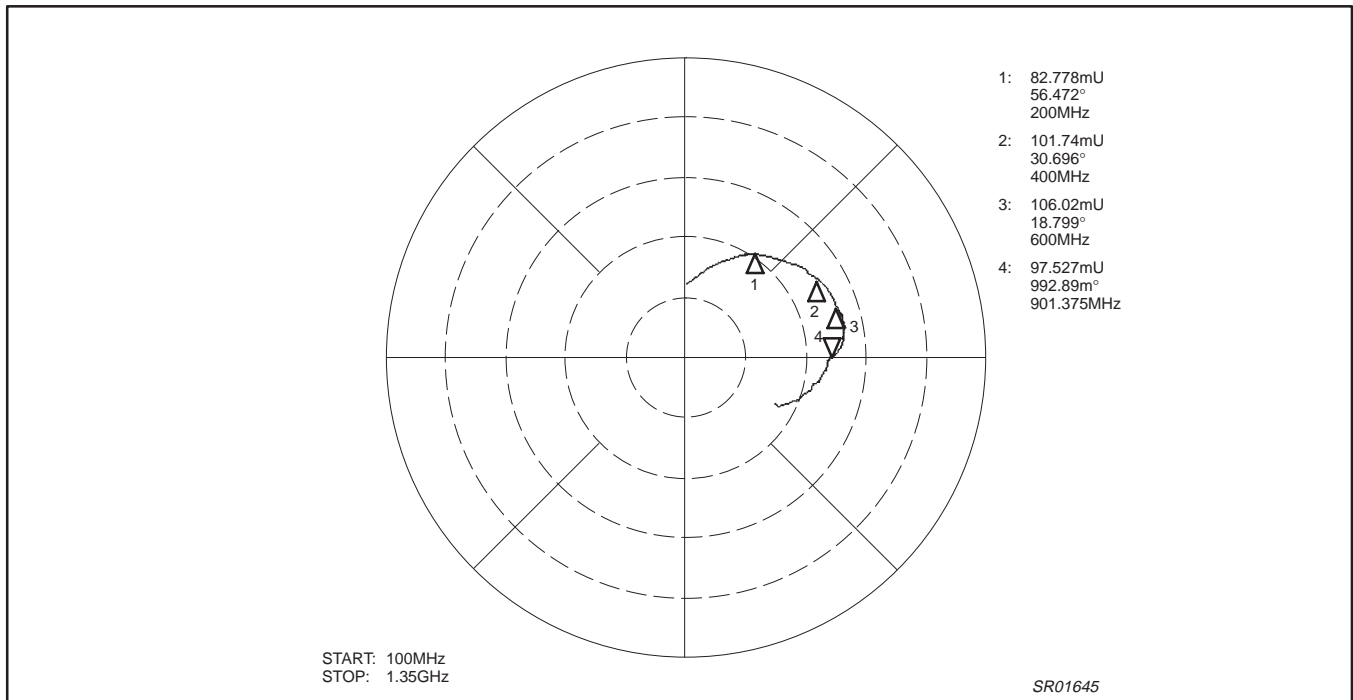

Figure 31. Typical S_{21} of the Low Band LNA @ 3.75V for Receive Strong Signal Mode

Dual-band RF front-end

SA1920

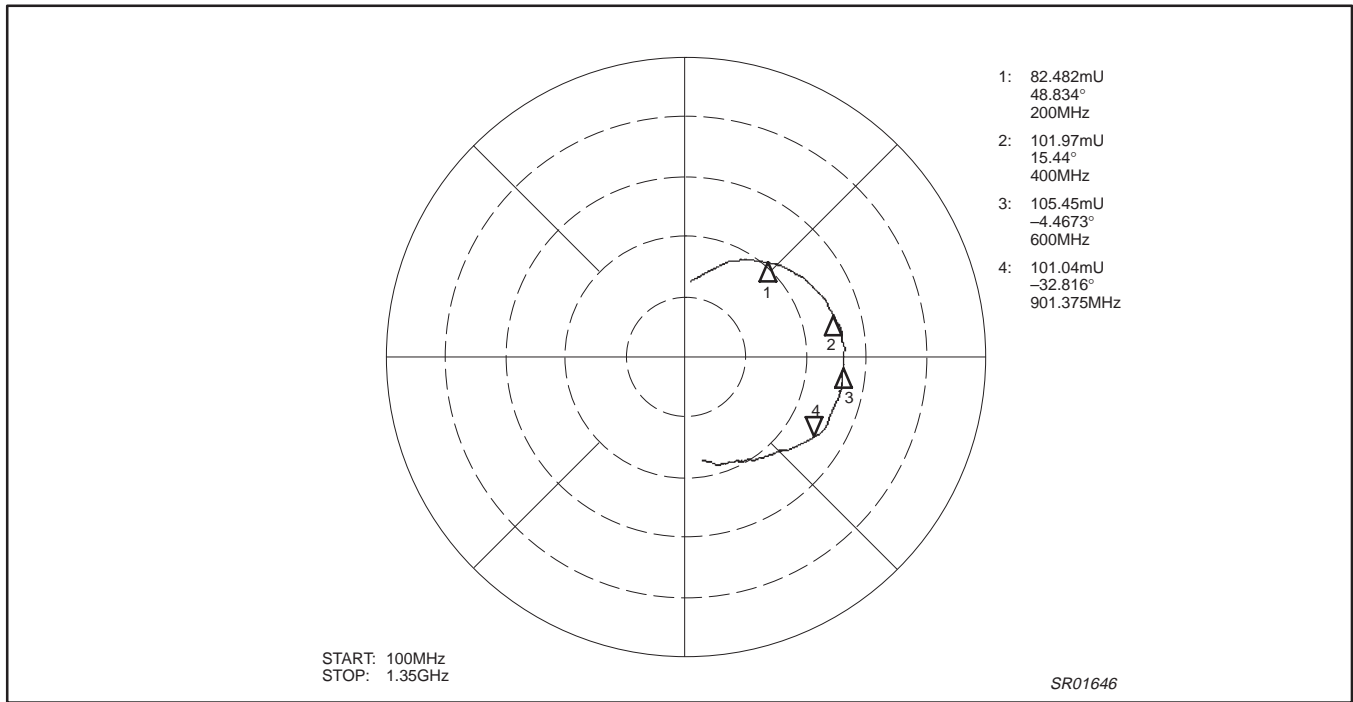

Figure 32. Typical S_{12} for the Low Band LNA @ 3.75V for the Receive Strong Signal Mode

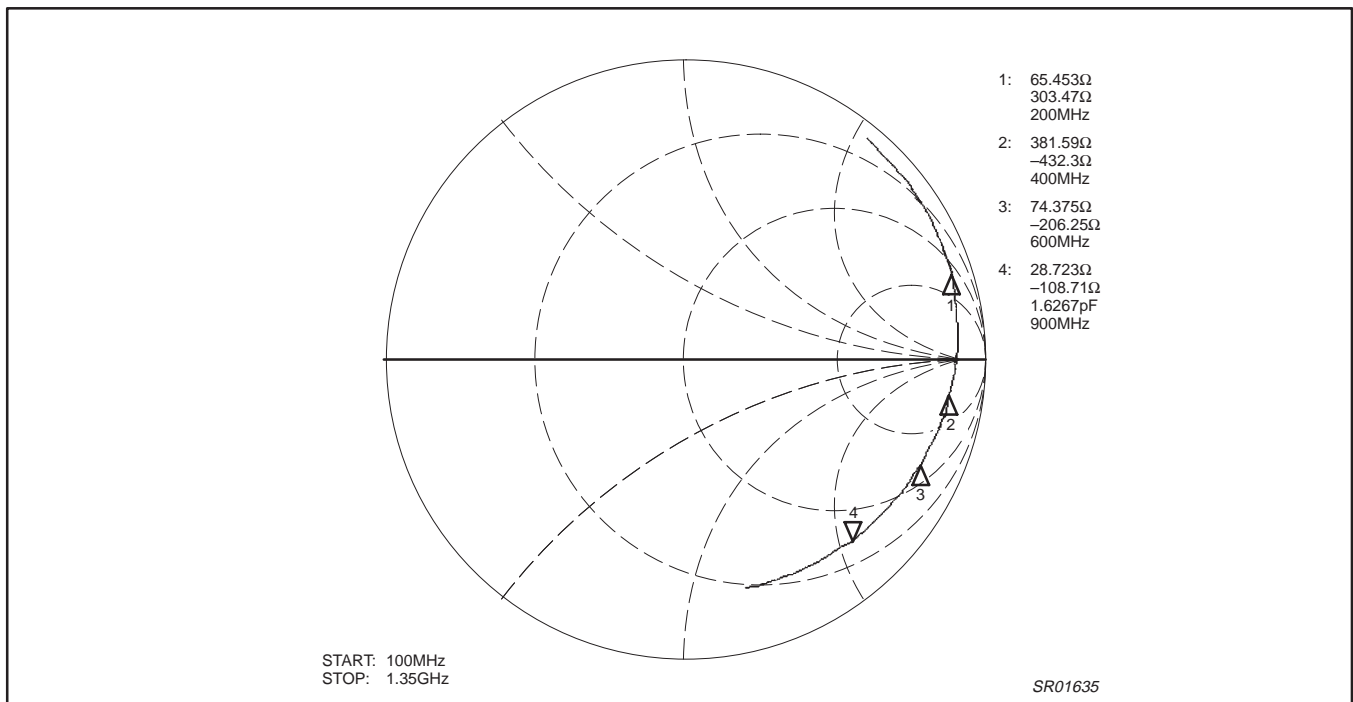

Figure 33. Typical S_{22} for the Low Band LNA @ 3.75V for the Strong Receive Signal Mode

Dual-band RF front-end

SA1920

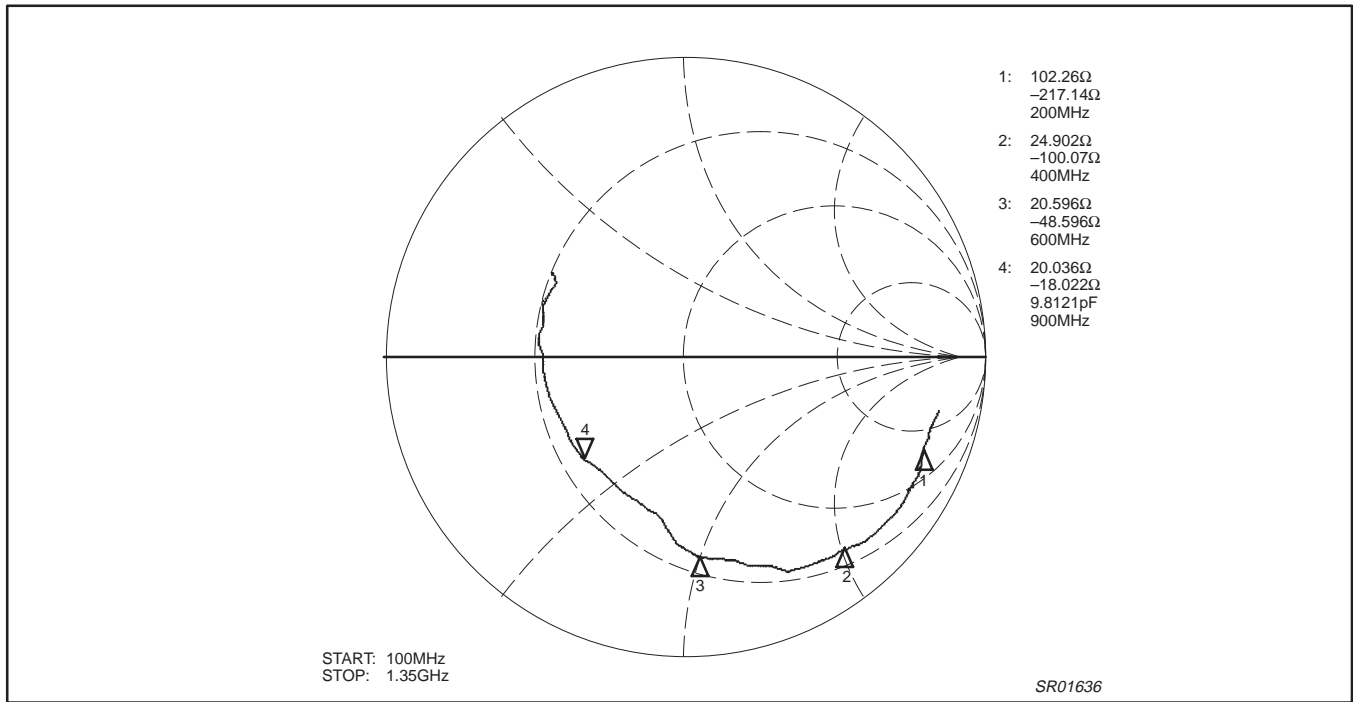

Figure 34. Typical S_{11} for the Low Band Mixer @ 3.75V for the Receive Normal Mode

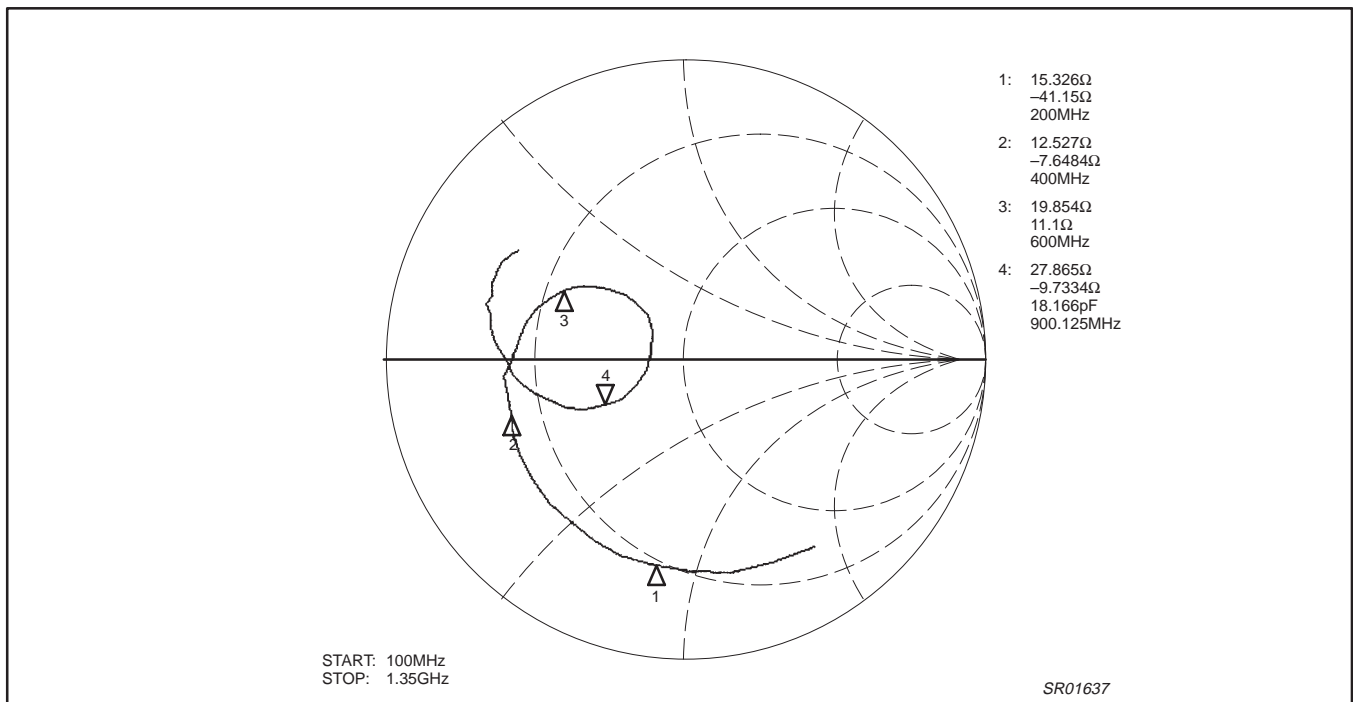

Figure 35. Typical S_{11} for the Low Band LO @ 3.75V for the Low Band Receive Normal Mode

Dual-band RF front-end

SA1920

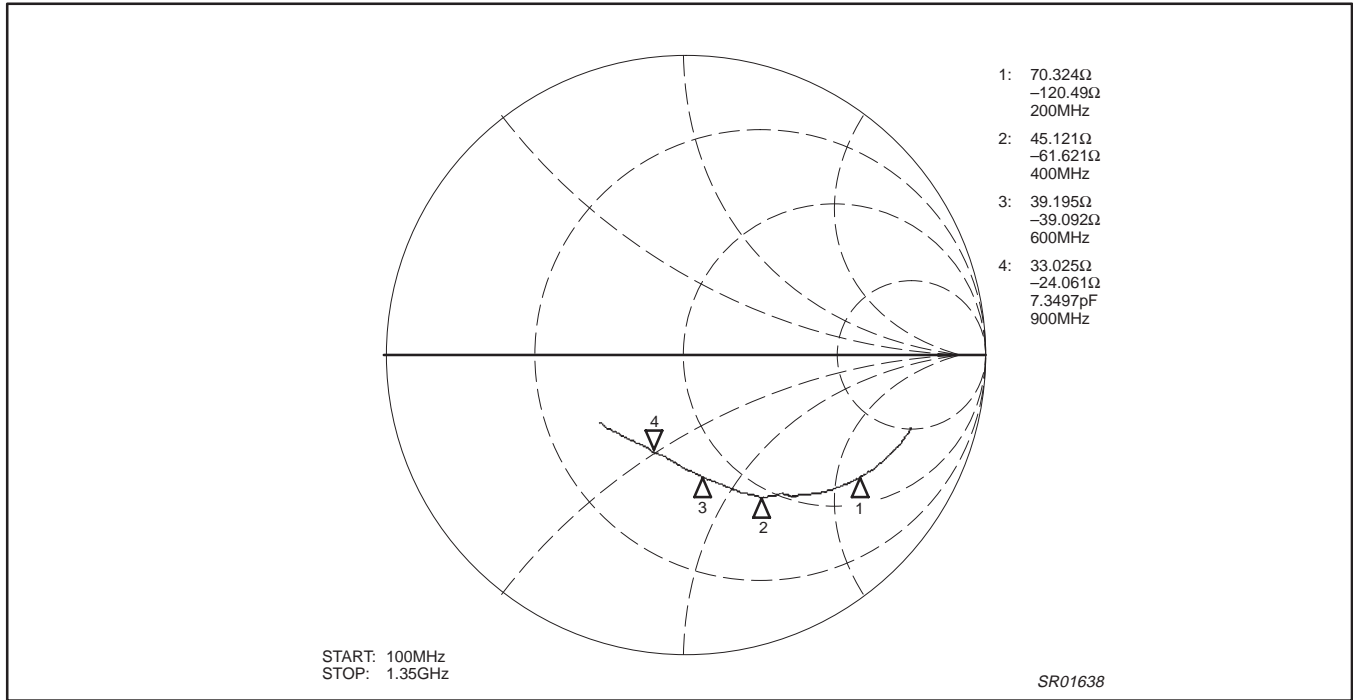

Figure 36. Typical S_{11} for the Low Band LNA @ 3.75V for the Low Band Transmit (Analog) Mode

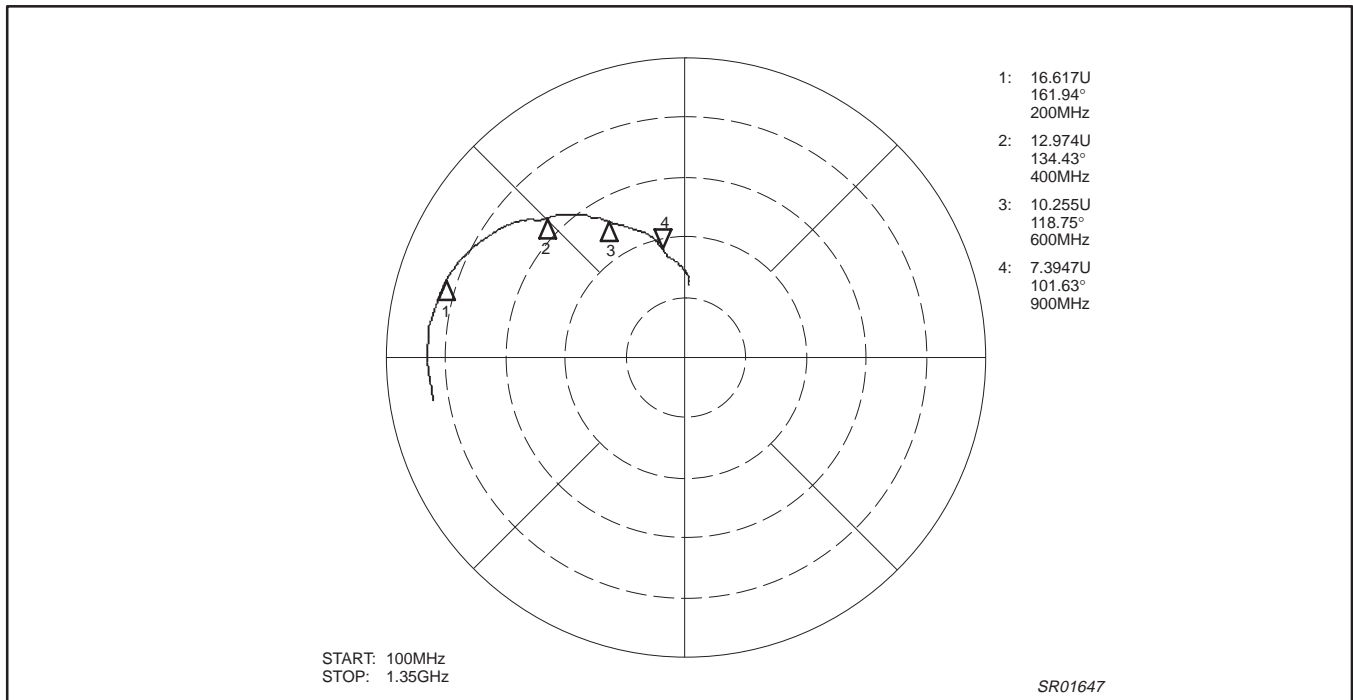

Figure 37. Typical S_{21} of the Low Band LNA @ 3.75V for the Low Band Transmit (Analog) Mode

Dual-band RF front-end

SA1920

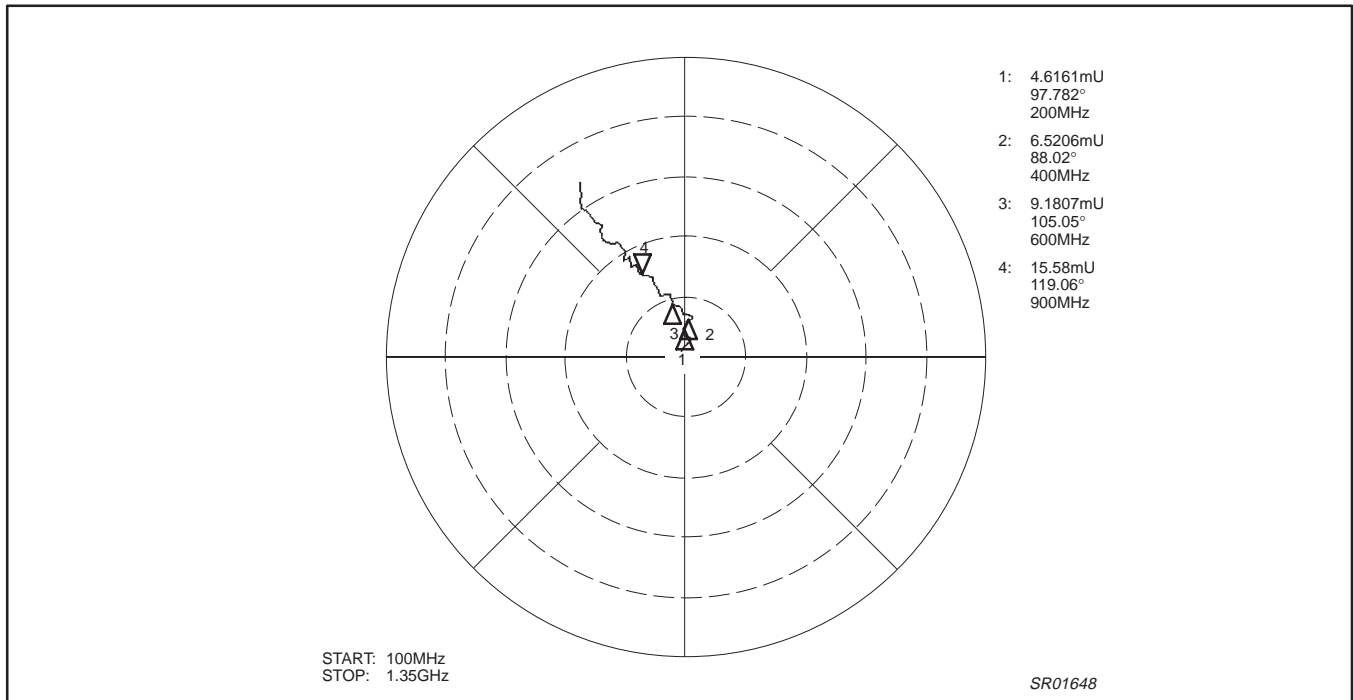

Figure 38. Typical S_{12} for the Low Band LNA @ 3.75V for the Low Band Transmit (Analog) Mode

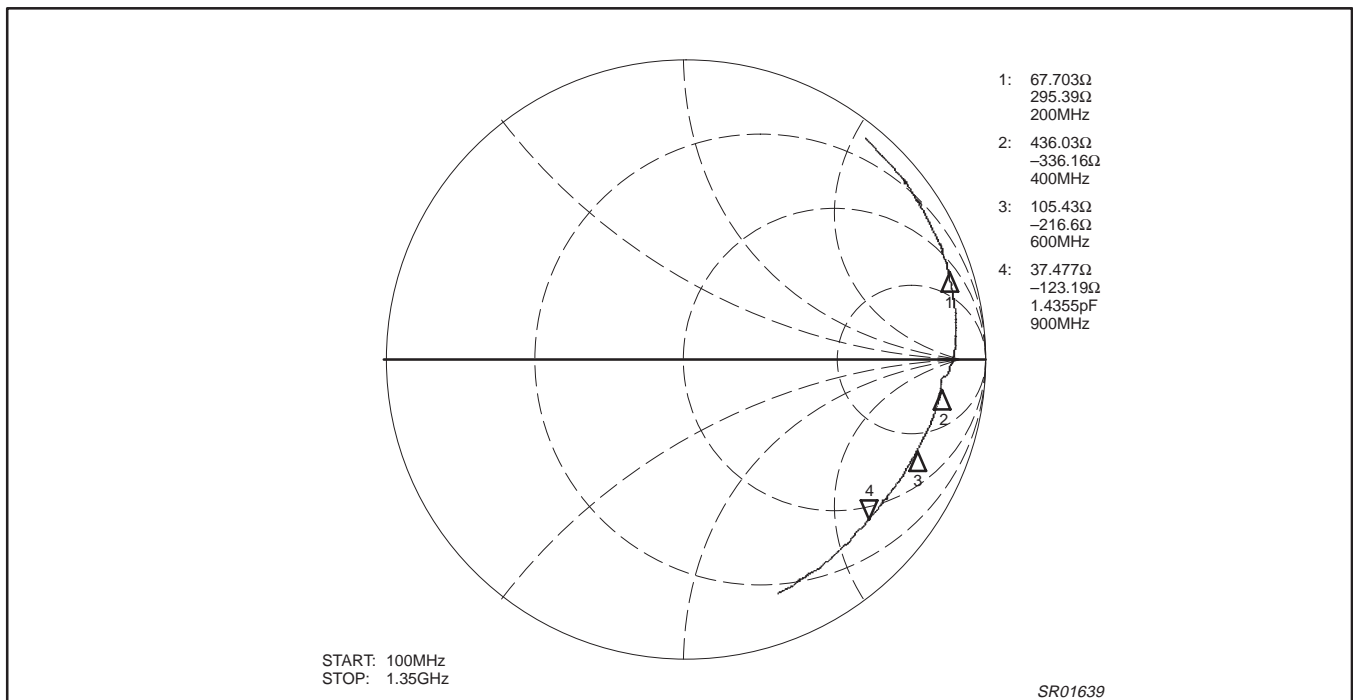

Figure 39. Typical S_{22} for the Low Band LNA @ 3.75V for the Low Band Transmit (Analog) Mode

Dual-band RF front-end

SA1920

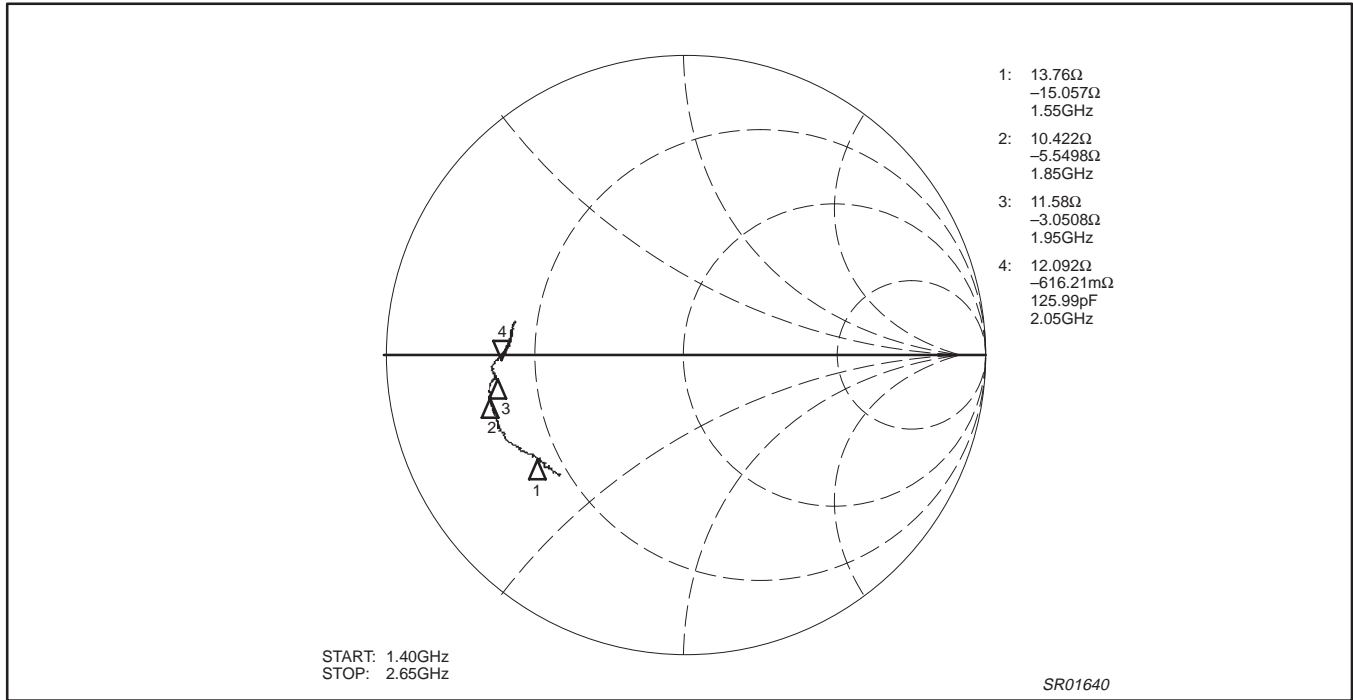

Figure 40. Typical S_{11} for the High Band LNA @ 3.75V for the High Band Receive Normal Mode

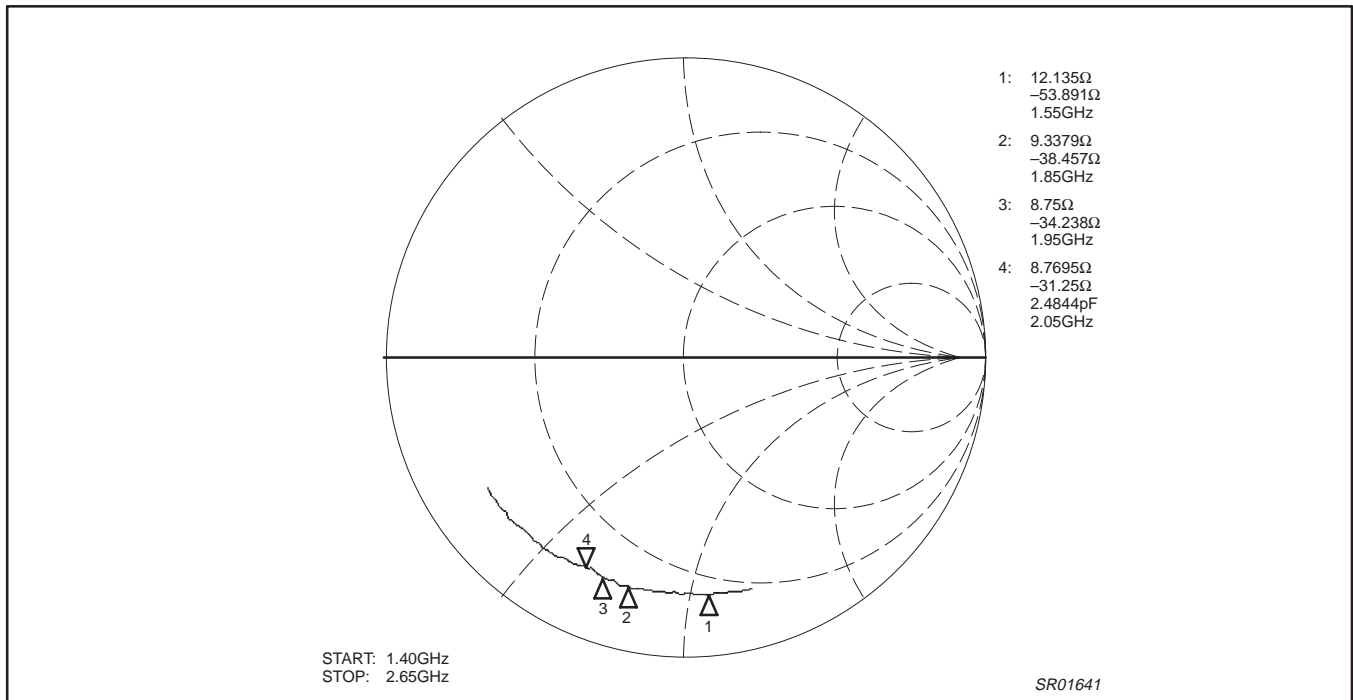

Figure 41. Typical S_{11} for the High Band LNA @ 3.75V for the High Band Receive Strong Signal Mode

Dual-band RF front-end

SA1920

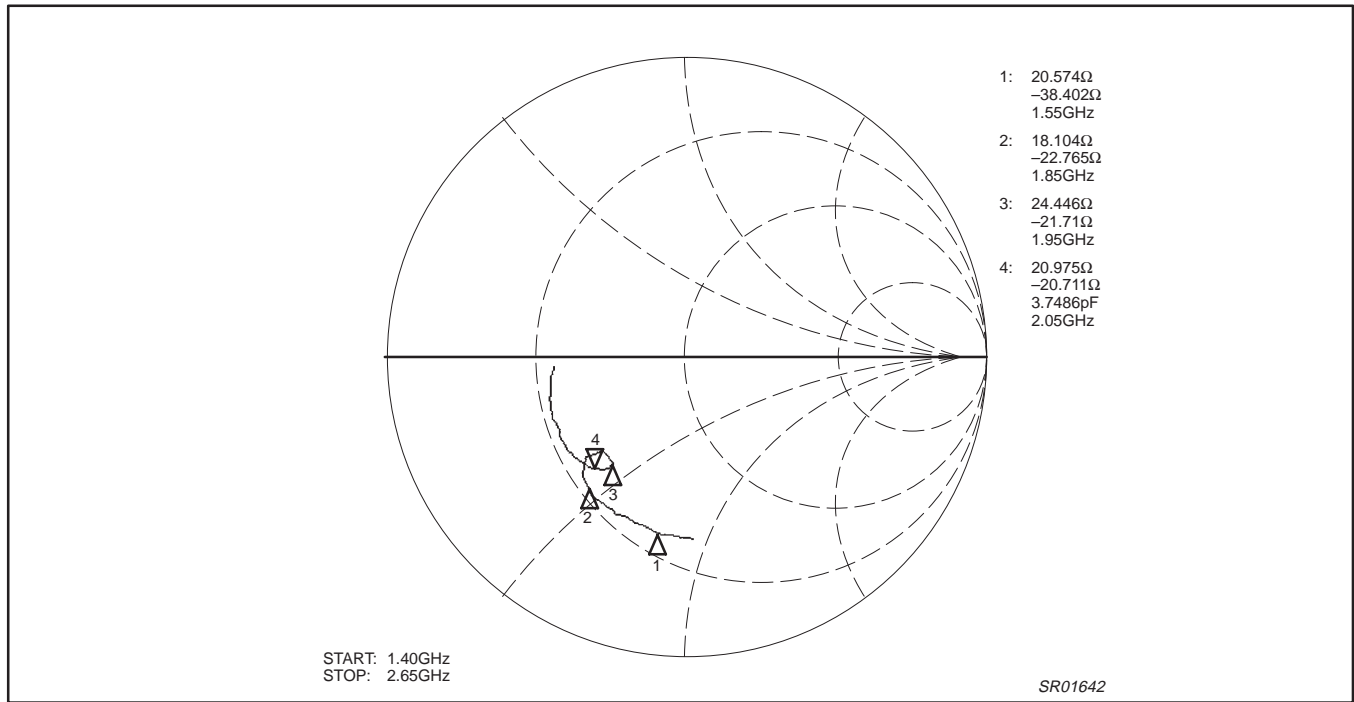

Figure 42. Typical S_{11} of the High Band LO @ 3.75V for the High Band Receive Normal Mode

Dual-band RF front-end

SA1920

Table 2. Typical S-Parameters of Low Band LNA at $V_{CC} = +3.75V$, LB Receive Normal Mode

FREQ (MHz)	S11 (U)	<S11 (DEG)	S21 (U)	<S21 (DEG)	S12 (U)	<S12 (DEG)	S22 (U)	<S22 (DEG)
100	0.89	-15.49	8.70	-165.43	0.0027	108.66	0.97	51.38
150	0.87	-22.76	8.71	-179.74	0.0038	93.41	0.96	31.54
200	0.85	-29.87	8.53	170.16	0.0049	92.10	0.96	19.54
250	0.82	-37.01	8.33	161.71	0.0065	86.08	0.95	11.08
300	0.79	-43.99	8.12	154.61	0.0071	82.95	0.94	4.19
350	0.75	-50.47	7.75	148.41	0.0078	69.24	0.93	-1.56
400	0.73	-56.72	7.49	144.24	0.0072	71.73	0.91	-5.69
450	0.70	-63.14	7.24	139.14	0.0078	76.99	0.91	-10.06
500	0.67	-69.13	6.97	134.34	0.0071	82.72	0.90	-13.94
550	0.63	-75.14	6.71	130.13	0.0078	84.15	0.89	-17.69
600	0.61	-81.15	6.45	126.62	0.0074	87.69	0.88	-21.14
650	0.59	-86.84	6.23	122.98	0.0079	91.07	0.88	-24.77
700	0.57	-92.30	6.03	119.16	0.0085	103.71	0.87	-28.09
750	0.55	-97.73	5.80	115.55	0.0098	103.73	0.87	-31.38
800	0.54	-102.99	5.56	111.56	0.0107	113.57	0.86	-34.82
850	0.53	-108.21	5.24	107.93	0.0121	115.45	0.86	-38.18
900	0.52	-113.27	4.97	105.40	0.0134	124.98	0.86	-41.51
950	0.51	-118.12	4.75	104.08	0.0155	127.67	0.86	-44.72
1000	0.51	-122.43	4.62	102.52	0.0175	128.87	0.86	-47.96
1050	0.51	-126.73	4.52	99.54	0.0193	128.89	0.86	-51.12
1100	0.50	-130.83	4.34	96.33	0.0217	129.85	0.86	-54.20
1150	0.51	-134.58	4.13	93.78	0.0238	128.74	0.86	-57.23
1200	0.51	-138.20	3.94	91.13	0.0269	131.20	0.86	-60.03
1250	0.51	-141.69	3.72	88.49	0.0297	130.22	0.87	-62.72
1300	0.51	-145.12	3.46	86.84	0.032	128.07	0.87	-65.57
1350	0.52	-148.25	3.25	86.69	0.033	127.73	0.87	-68.10

Dual-band RF front-end

SA1920

Table 3. Typical S-Parameters of Low Band LNA at $V_{CC} = +3.75V$, LB Strong Signal Mode

FREQ (MHz)	S11 (U)	<S11 (DEG)	S21 (U)	<S21 (DEG)	S12 (U)	<S12 (DEG)	S22 (U)	<S22 (DEG)
100	0.94	-8.77	0.05	88.15	0.049	84.08	0.96	50.15
150	0.92	-12.15	0.07	68.32	0.069	63.51	0.95	30.01
200	0.90	-15.01	0.08	55.23	0.082	47.79	0.93	17.79
250	0.88	-17.75	0.09	46.14	0.090	37.04	0.92	9.22
300	0.87	-20.37	0.09	39.25	0.094	28.09	0.91	2.68
350	0.85	-23.15	0.10	33.96	0.099	21.40	0.90	-2.68
400	0.85	-25.85	0.10	29.86	0.100	14.70	0.89	-7.56
450	0.84	-28.73	0.10	26.35	0.102	9.32	0.88	-12.06
500	0.83	-31.65	0.10	23.06	0.103	4.37	0.88	-16.23
550	0.82	-34.56	0.10	20.07	0.103	-0.41	0.87	-20.35
600	0.81	-38.02	0.10	17.87	0.103	-5.17	0.86	-24.23
650	0.80	-41.41	0.10	15.28	0.104	-9.07	0.85	-28.29
700	0.80	-44.70	0.10	12.27	0.104	-13.29	0.85	-32.11
750	0.79	-48.40	0.10	9.05	0.103	-18.00	0.84	-35.85
800	0.78	-52.30	0.10	5.24	0.103	-23.07	0.83	-39.74
850	0.78	-56.58	0.10	2.20	0.102	-28.68	0.83	-43.59
900	0.77	-60.63	0.09	-0.26	0.099	-33.94	0.82	-47.19
950	0.77	-64.88	0.09	-2.21	0.094	-39.65	0.82	-50.95
1000	0.76	-69.05	0.09	-4.19	0.090	-44.01	0.81	-54.29
1050	0.76	-73.21	0.09	-7.58	0.086	-47.95	0.81	-57.67
1100	0.76	-77.26	0.09	-11.56	0.084	-52.34	0.81	-60.86
1150	0.76	-81.34	0.08	-16.05	0.080	-58.43	0.80	-64.05
1200	0.76	-85.37	0.08	-19.50	0.076	-62.90	0.80	-66.96
1250	0.76	-89.33	0.07	-23.71	0.074	-68.35	0.80	-69.89
1300	0.76	-93.28	0.07	-27.20	0.072	-75.17	0.79	-72.64
1350	0.75	-97.37	0.06	-31.20	0.068	-82.58	0.79	-75.21

Dual-band RF front-end

SA1920

Table 4. Typical S-Parameters of Low Band LNA at $V_{CC} = +3.75V$, LB Transmit On (Analog) Mode

FREQ (MHz)	S11 (U)	<S11 (DEG)	S21 (U)	<S21 (DEG)	S12 (U)	<S12 (DEG)	S22 (U)	<S22 (DEG)
100	0.80	-18.49	16.98	-170.30	0.003	121.40	0.95	50.55
150	0.76	-27.25	17.07	173.61	0.004	100.49	0.94	30.44
200	0.72	-35.34	16.62	161.95	0.005	87.01	0.93	18.29
250	0.67	-43.14	15.82	152.47	0.005	88.74	0.92	9.80
300	0.62	-50.04	14.89	144.65	0.007	80.87	0.91	2.68
350	0.57	-55.41	13.73	138.33	0.007	64.95	0.89	-2.99
400	0.55	-61.58	12.97	134.43	0.007	90.16	0.87	-6.38
450	0.51	-67.13	12.27	129.49	0.007	90.97	0.86	-10.66
500	0.47	-72.08	11.53	125.20	0.008	89.19	0.85	-14.35
550	0.44	-76.94	10.83	121.58	0.009	96.23	0.84	-17.92
600	0.42	-81.92	10.24	118.69	0.009	98.83	0.84	-21.27
650	0.40	-86.62	9.78	115.74	0.009	102.03	0.83	-24.85
700	0.38	-91.05	9.32	112.66	0.010	107.95	0.83	-28.04
750	0.37	-95.76	8.89	109.66	0.012	108.58	0.83	-31.27
800	0.36	-100.37	8.46	106.44	0.012	114.73	0.82	-34.68
850	0.35	-105.06	7.92	103.48	0.014	115.62	0.82	-38.05
900	0.34	-109.12	7.39	101.58	0.015	116.40	0.82	-41.29
950	0.34	-113.76	7.02	100.76	0.017	116.04	0.82	-44.70
1000	0.34	-117.50	6.81	99.95	0.019	122.13	0.82	-47.58
1050	0.34	-121.31	6.64	97.57	0.021	122.61	0.83	-50.73
1100	0.34	-124.67	6.36	94.92	0.023	121.36	0.83	-53.76
1150	0.35	-127.76	6.09	92.79	0.025	123.58	0.83	-56.81
1200	0.35	-130.93	5.80	90.59	0.026	125.25	0.83	-59.62
1250	0.36	-133.78	5.48	88.25	0.030	123.53	0.84	-62.32
1300	0.36	-136.90998	5.10	87.00	0.03	122.37	0.84	-65.27
1350	0.37	-140.02216	4.82	87.05	0.03	122.64	0.85	-68.06

Dual-band RF front-end

SA1920

Table 5. Typical S-Parameters of Low Band Mixer Input at $V_{CC} = +3.75V$, LB Receive Normal Mode

FREQ (MHz)	S11 (U)	<S11 (DEG)
100	0.85	-13.10
150	0.84	-17.65
200	0.85	-23.74
250	0.85	-29.63
300	0.85	-37.49
350	0.85	-45.23
400	0.85	-54.50
450	0.80	-64.14
500	0.75	-73.90
550	0.70	-82.34
600	0.67	-91.47
650	0.57	-100.54
700	0.53	-106.44
750	0.51	-114.37
800	0.49	-123.87
850	0.48	-132.17
900	0.49	-141.42
950	0.47	-150.07
1000	0.47	-160.64
1050	0.47	-169.49
1100	0.47	-179.79
1150	0.48	171.14
1200	0.48	162.01
1250	0.49	154.08
1300	0.50	144.55
1350	0.51	136.11

Dual-band RF front-end

SA1920

Table 6. Typical S-Parameters of Low Band LO Input at $V_{CC} = +3.75V$, LB Receive Normal Mode

FREQ (MHz)	S11 (U)	<S11 (DEG)
100	0.76	-55.83
150	0.73	-78.35
200	0.70	-98.64
250	0.68	-116.73
300	0.66	-133.17
350	0.64	-147.82
400	0.61	-161.51
450	0.59	-173.68
500	0.55	173.99
550	0.51	162.15
600	0.46	150.30
650	0.38	140.69
700	0.29	132.76
750	0.18	131.71
800	0.10	171.44
850	0.18	-150.19
900	0.31	-149.41
950	0.42	-157.78
1000	0.50	-166.73
1050	0.57	-175.14
1100	0.61	177.49
1150	0.64	170.74
1200	0.66	164.22
1250	0.68	157.61
1300	0.68	150.89
1350	0.65	144.80

Dual-band RF front-end

SA1920

Table 7. Typical S-Parameters of HB LNA Input at $V_{CC} = +3.75V$, HB Receive Normal Mode

FREQ (MHz)	S11 (U)	<S11 (DEG)
1400	0.58	-135.43
1450	0.59	-138.48
1500	0.59	-141.42
1550	0.60	-144.44
1600	0.62	-146.93
1650	0.63	-149.85
1700	0.65	-154.08
1750	0.66	-158.38
1800	0.66	-162.67
1850	0.66	-167.09
1900	0.65	-170.72
1950	0.63	-172.76
2000	0.64	-175.38
2050	0.61	-178.44
2100	0.60	-179.38
2150	0.59	179.32
2200	0.58	178.44
2250	0.58	177.61
2300	0.57	176.29
2350	0.57	175.39
2400	0.57	174.35
2450	0.56	173.01
2500	0.57	172.12
2550	0.57	170.91
2600	0.56	169.89
2650	0.56	168.41

Dual-band RF front-end

SA1920

Table 8. Typical S-Parameters of HB LNA Input at $V_{CC} = +3.75V$, HB Strong Signal Mode

FREQ (MHz)	S11 (U)	<S11 (DEG)
1400	0.81	-73.99
1450	0.81	-77.23
1500	0.81	-80.62
1550	0.80	-84.00
1600	0.80	-87.02
1650	0.80	-90.35
1700	0.79	-93.54
1750	0.79	-96.48
1800	0.79	-100.32
1850	0.79	-103.54
1900	0.79	-107.23
1950	0.79	-110.05
2000	0.77	-113.75
2050	0.78	-114.79
2100	0.79	-117.61
2150	0.79	-120.50
2200	0.80	-122.65
2250	0.79	-125.91
2300	0.80	-128.17
2350	0.79	-130.64
2400	0.79	-133.19
2450	0.79	-135.66
2500	0.79	-138.22
2550	0.79	-140.56
2600	0.79	-143.22
2650	0.79	-145.47

Dual-band RF front-end

SA1920

Table 9. Typical S-Parameters of HB LO Input at $V_{CC} = +3.75V$, HB Receive Normal Mode

FREQ (MHz)	S11 (U)	<S11 (DEG)
1400	0.62	-87.50
1450	0.61	-90.87
1500	0.60	-94.44
1550	0.60	-98.86
1600	0.59	-102.10
1650	0.59	-106.34
1700	0.58	-110.67
1750	0.57	-114.48
1800	0.57	-119.86
1850	0.55	-126.14
1900	0.48	-134.66
1950	0.43	-123.95
2000	0.47	-126.26
2050	0.48	-128.33
2100	0.50	-131.34
2150	0.50	-135.52
2200	0.50	-138.76
2250	0.50	-142.68
2300	0.50	-146.60
2350	0.49	-150.21
2400	0.49	-154.30
2450	0.48	-157.62
2500	0.47	-161.79
2550	0.46	-166.32
2600	0.45	-170.41
2650	0.43	-174.86

Dual-band RF front-end

SA1920

LQFP48: plastic low profile quad flat package; 48 leads; body 7 x 7 x 1.4 mm

SOT313-2

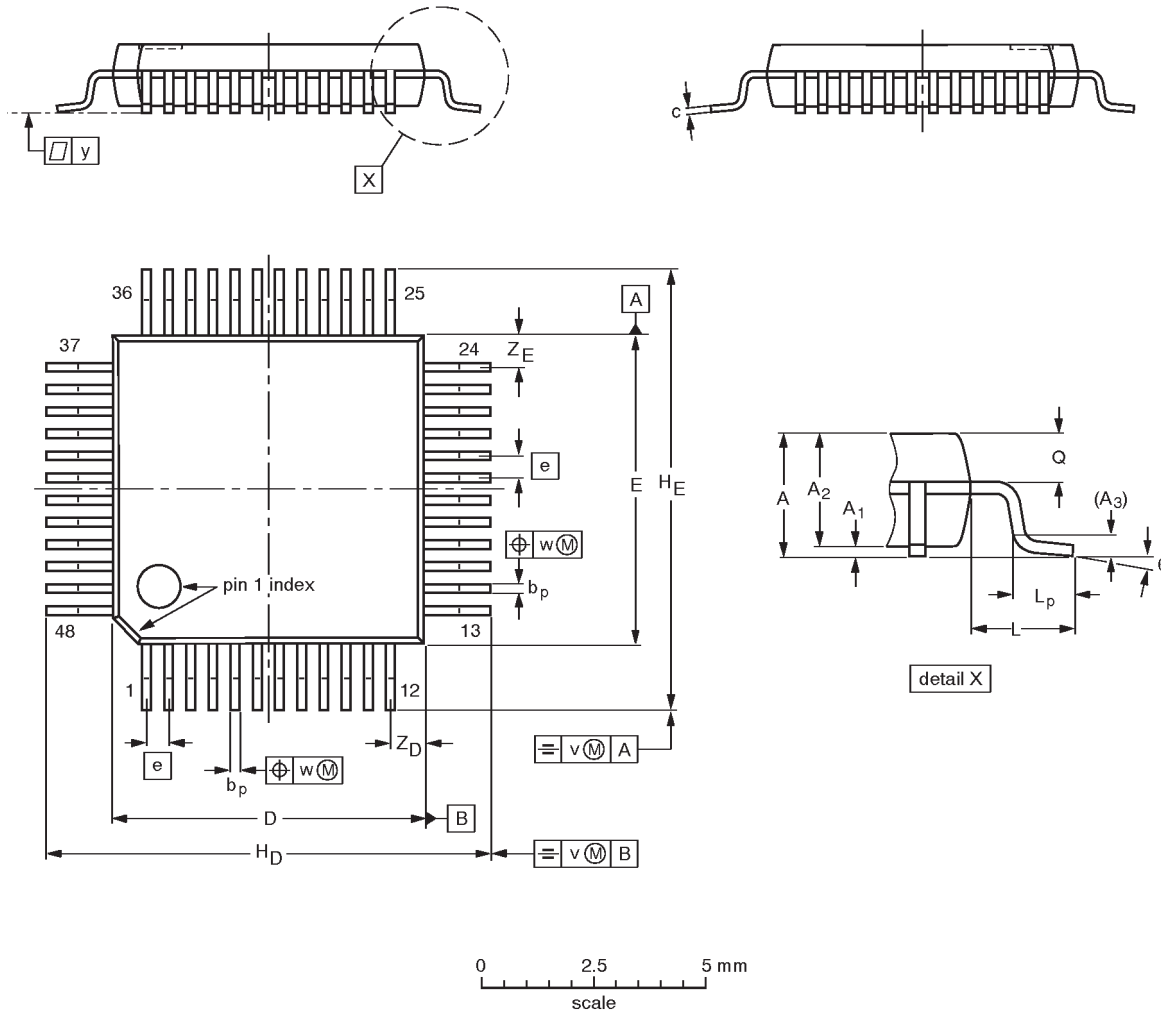

DIMENSIONS (mm are the original dimensions)

UNIT	A max.	A ₁	A ₂	A ₃	b _p	c	D ⁽¹⁾	E ⁽¹⁾	e	H _D	H _E	L	L _p	Q	v	w	y	Z _D ⁽¹⁾	Z _E ⁽¹⁾	θ
mm	1.60	0.20 0.05	1.45 1.35	0.25	0.27 0.17	0.18 0.12	7.1 6.9	7.1 6.9	0.5	9.15 8.85	9.15 8.85	1.0	0.75 0.45	0.69 0.59	0.2	0.12	0.1	0.95 0.55	0.95 0.55	7° 0°

Note

1. Plastic or metal protrusions of 0.25 mm maximum per side are not included.

OUTLINE VERSION	REFERENCES				EUROPEAN PROJECTION	ISSUE DATE
	IEC	JEDEC	EIAJ			
SOT313-2						93-06-15- 94-12-19

Dual-band RF front-end

SA1920

NOTES

Dual-band RF front-end

SA1920

Data sheet status

Data sheet status	Product status	Definition [1]
Objective specification	Development	This data sheet contains the design target or goal specifications for product development. Specification may change in any manner without notice.
Preliminary specification	Qualification	This data sheet contains preliminary data, and supplementary data will be published at a later date. Philips Semiconductors reserves the right to make changes at any time without notice in order to improve design and supply the best possible product.
Product specification	Production	This data sheet contains final specifications. Philips Semiconductors reserves the right to make changes at any time without notice in order to improve design and supply the best possible product.

[1] Please consult the most recently issued datasheet before initiating or completing a design.

Definitions

Short-form specification — The data in a short-form specification is extracted from a full data sheet with the same type number and title. For detailed information see the relevant data sheet or data handbook.

Limiting values definition — Limiting values given are in accordance with the Absolute Maximum Rating System (IEC 134). Stress above one or more of the limiting values may cause permanent damage to the device. These are stress ratings only and operation of the device at these or at any other conditions above those given in the Characteristics sections of the specification is not implied. Exposure to limiting values for extended periods may affect device reliability.

Application information — Applications that are described herein for any of these products are for illustrative purposes only. Philips Semiconductors make no representation or warranty that such applications will be suitable for the specified use without further testing or modification.

Disclaimers

Life support — These products are not designed for use in life support appliances, devices or systems where malfunction of these products can reasonably be expected to result in personal injury. Philips Semiconductors customers using or selling these products for use in such applications do so at their own risk and agree to fully indemnify Philips Semiconductors for any damages resulting from such application.

Right to make changes — Philips Semiconductors reserves the right to make changes, without notice, in the products, including circuits, standard cells, and/or software, described or contained herein in order to improve design and/or performance. Philips Semiconductors assumes no responsibility or liability for the use of any of these products, conveys no license or title under any patent, copyright, or mask work right to these products, and makes no representations or warranties that these products are free from patent, copyright, or mask work right infringement, unless otherwise specified.

Philips Semiconductors
811 East Arques Avenue
P.O. Box 3409
Sunnyvale, California 94088-3409
Telephone 800-234-7381

© Copyright Philips Electronics North America Corporation 1999
All rights reserved. Printed in U.S.A.

Date of release: 03-99

Document order number:

9397 750 05354

Let's make things better.