

Photo Module for High Data Rates PCM Remote Control Systems

Available types for different carrier frequencies

Type	fo	Type	fo
TSOP5230	30 kHz	TSOP5233	33 kHz
TSOP5236	36 kHz	TSOP5237	36.7 kHz
TSOP5238	38 kHz	TSOP5240	40 kHz
TSOP5256	56 kHz		

Description

The TSOP52.. – series are miniaturized SMD–IR Receiver Modules for infrared remote control systems. PIN diode and preamplifier are assembled on lead frame, the epoxy package is designed as IR filter. The demodulated output signal can directly be decoded by a microprocessor. TSOP52.. is the standard IR remote control SMD–Receiver series, supporting all major transmission codes.

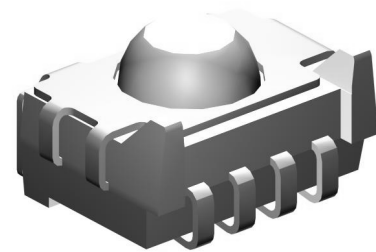

16797

Features

- Photo detector and preamplifier in one package
- Internal filter for PCM frequency
- Continuous data transmission possible
- TTL and CMOS compatibility
- Output active low
- Low power consumption
- High immunity against ambient light
- Suitable burst length ≥ 10 cycles/burst
- Taping available for topview and sideview assembly

Block Diagram

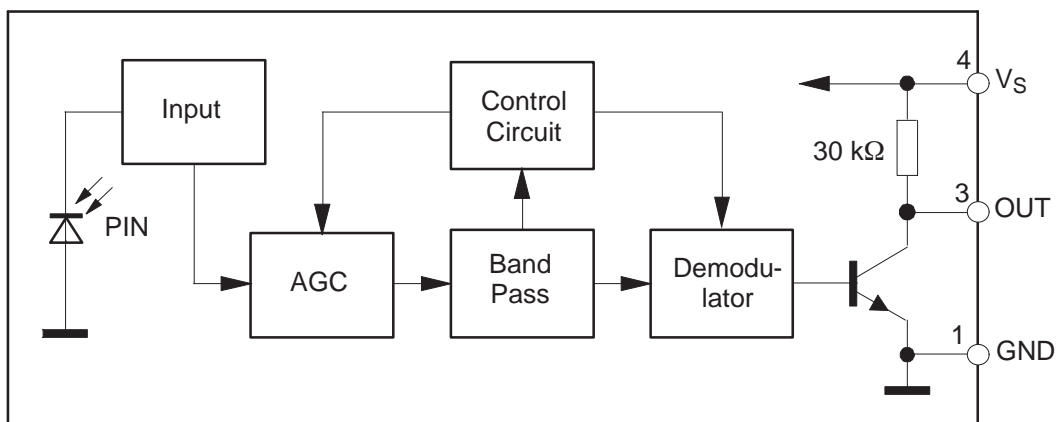

16798

Absolute Maximum Ratings

$T_{amb} = 25^{\circ}\text{C}$

Parameter	Test Conditions	Symbol	Value	Unit
Supply Voltage	Pin 4	V_S	-0.3...6.0	V
Supply Current	Pin 4	I_S	5	mA
Output Voltage	Pin 3	V_O	-0.3...6.0	V
Output Current	Pin 3	I_O	15	mA
Junction Temperature		T_j	100	$^{\circ}\text{C}$
Storage Temperature Range		T_{stg}	-40...+85	$^{\circ}\text{C}$
Operating Temperature Range		T_{amb}	-25...+85	$^{\circ}\text{C}$
Power Consumption	$T_{amb} \leq 85^{\circ}\text{C}$	P_{tot}	50	mW

Basic Characteristics

$T_{amb} = 25^{\circ}\text{C}$

Parameter	Test Conditions	Symbol	Min	Typ	Max	Unit
Supply Current	$V_S = 5\text{ V}, E_v = 0$	I_{SD}	0.8	1.1	1.5	mA
	$V_S = 5\text{ V}, E_v = 40\text{ klx, sunlight}$	I_{SH}		1.4		mA
Supply Voltage		V_S	4.5		5.5	V
Transmission Distance	$E_v = 0$, test signal see fig.7, IR diode TSAL6200, $I_F = 400\text{ mA}$	d		30		m
Output Voltage Low (Pin 3)	$I_{OSL} = 0.5\text{ mA}, E_e = 0.7\text{ mW/m}^2$	V_{OSL}			250	mV
Irradiance (30–40 kHz)	Pulse width tolerance: $t_{pi} - 5/f_o < t_{po} < t_{pi} + 6/f_o$, test signal see fig.7	$E_e\text{ min}$		0.5	0.6	mW/m^2
Irradiance (56 kHz)		$E_e\text{ min}$		0.6	0.7	mW/m^2
Irradiance	$t_{pi} - 5/f_o < t_{po} < t_{pi} + 6/f_o$	$E_e\text{ max}$	30			W/m^2
Directivity	Angle of half transmission distance	$\phi_{1/2}$		± 50		deg

Application Circuit

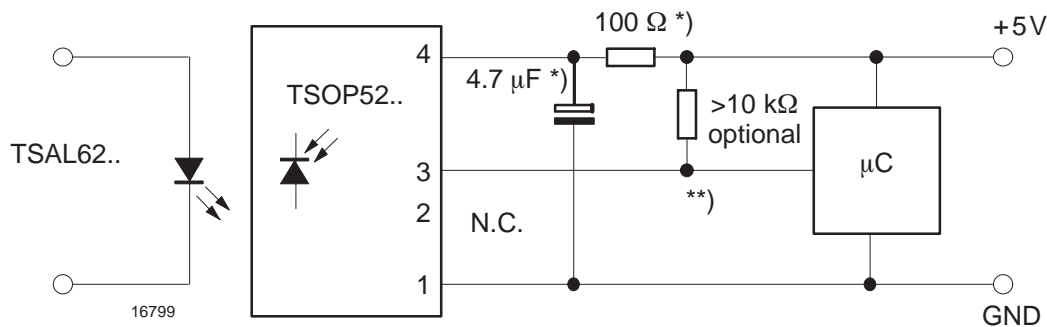

*) recommended to suppress power supply disturbances

***) the output voltage should not be hold continuously at a voltage below 3.3V by the external circuit.

Suitable Data Format

The circuit of the TSOP52.. is designed in that way that unexpected output pulses due to noise or disturbance signals are avoided. A bandpassfilter, an integrator stage and an automatic gain control are used to suppress such disturbances.

The distinguishing mark between data signal and disturbance signal are carrier frequency, burst length and duty cycle.

The data signal should fulfill the following condition:

- Carrier frequency should be close to center frequency of the bandpass (e.g. 38kHz).
- Burst length should be 10 cycles/burst or longer.
- After each burst which is between 10 cycles and 70 cycles a gap time of at least 14 cycles is necessary.
- For each burst which is longer than 1.8ms a corresponding gap time is necessary at some time in the data stream. This gap time should be at least 4 times longer than the burst.
- Up to 800 short bursts per second can be received continuously.

Some examples for suitable data format are: NEC Code, Toshiba Micom Format, Sharp Code, RC5 Code, RC6 Code, R-2000 Code.

When a disturbance signal is applied to the TSOP52.. it can still receive the data signal. However the sensitivity is reduced to that level that no unexpected pulses will occur.

Some examples for such disturbance signals which are suppressed by the TSOP52.. are:

- DC light (e.g. from tungsten bulb or sunlight)
- Continuous signal at 38kHz or at any other frequency
- Signals from fluorescent lamps with electronic ballast with high or low modulation (see Figure A or Figure B).

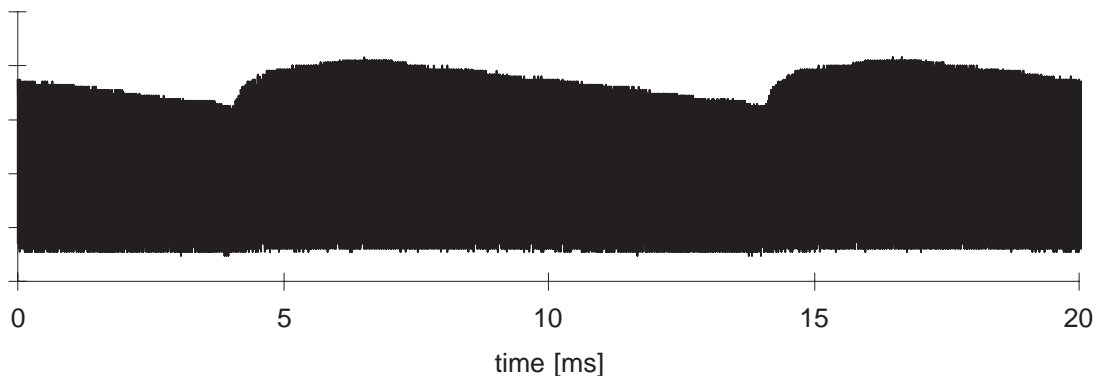

Figure A: IR Signal from Fluorescent Lamp with low Modulation

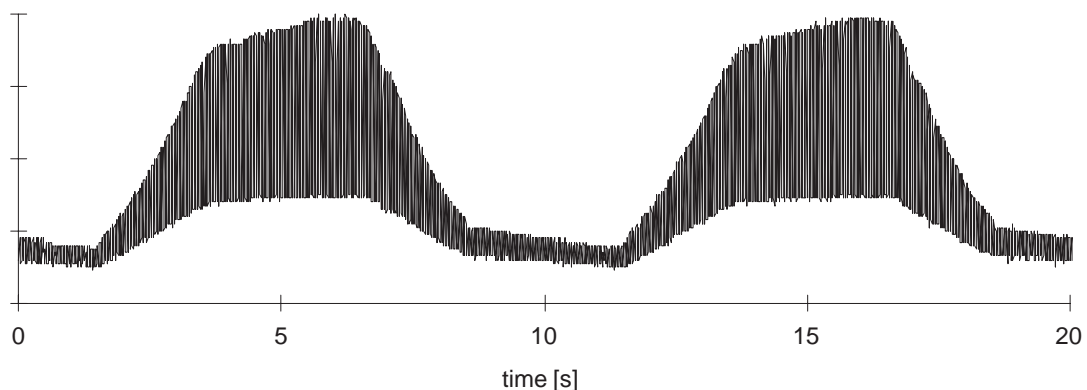
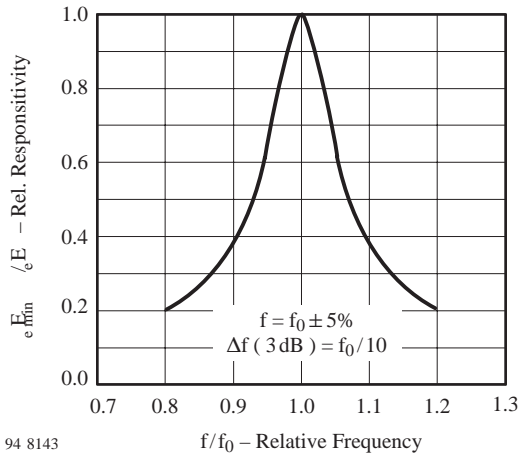

Figure B: IR Signal from Fluorescent Lamp with high Modulation

Typical Characteristics ($T_{amb} = 25^{\circ}\text{C}$ unless otherwise specified)



94 8143

Figure 1. Frequency Dependence of Responsivity

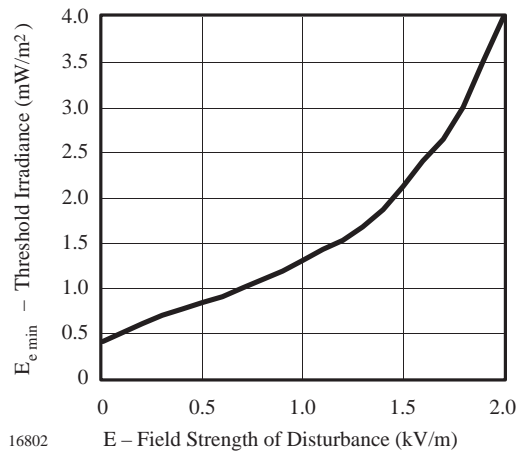

16802

Figure 4. Threshold Irradiance vs. Field Strength of Disturbance

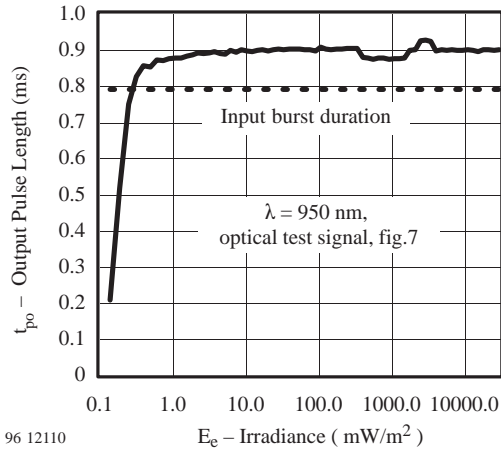

96 12110

Figure 2. Sensitivity in Dark Ambient

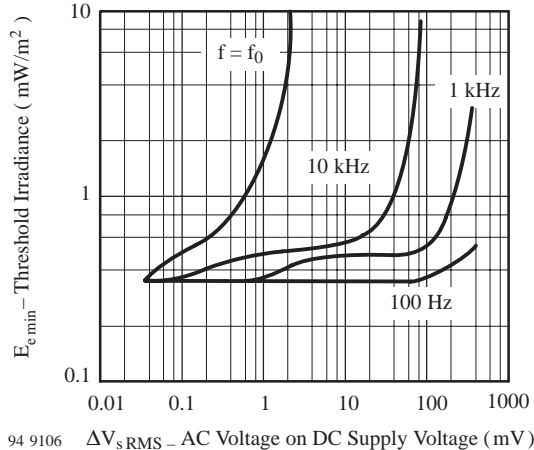

94 9106

Figure 5. Sensitivity vs. Supply Voltage Disturbances

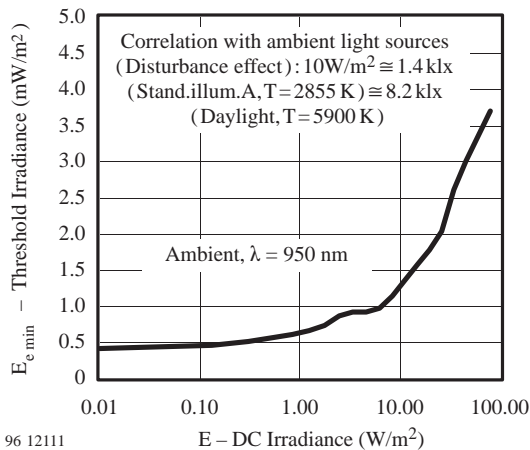

96 12111

Figure 3. Sensitivity in Bright Ambient

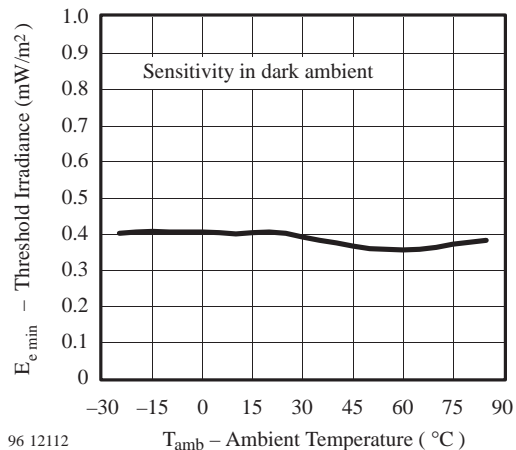

96 12112

Figure 6. Sensitivity vs. Ambient Temperature

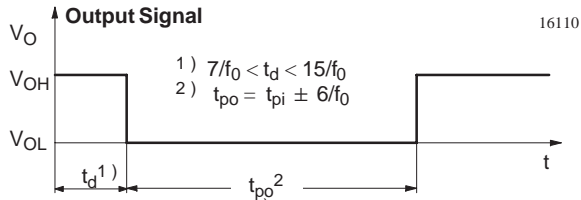
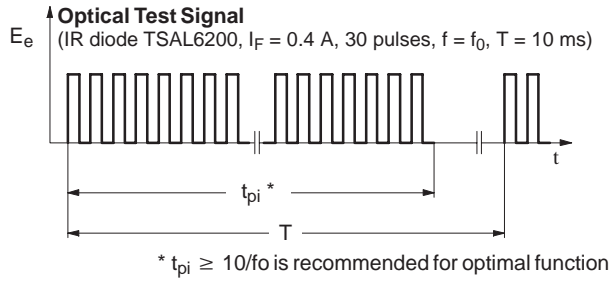

Figure 7. Output Function

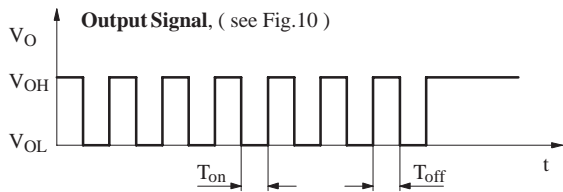
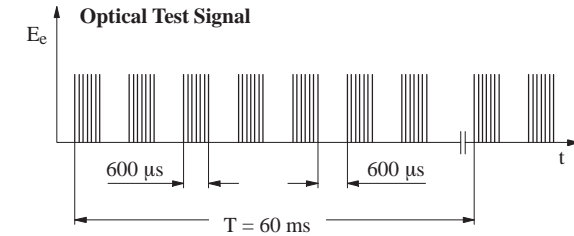
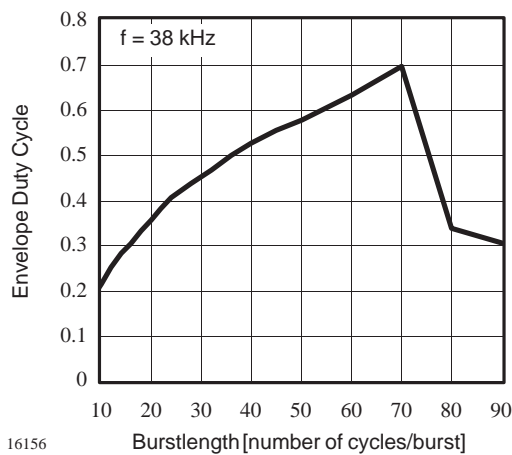
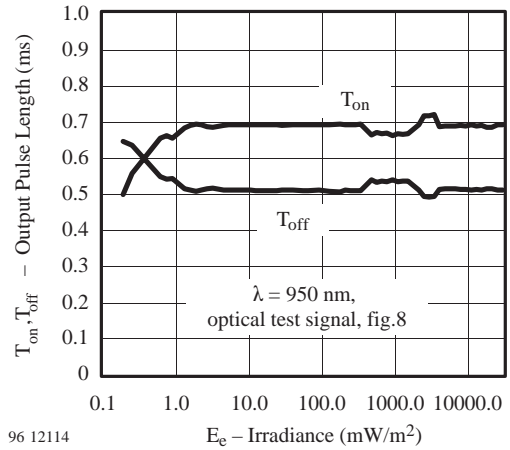

Figure 8. Output Function



16156

Figure 9. Max. Envelope Duty Cycle vs. Burstlength



96 12114

Figure 10. Output Pulse Diagram

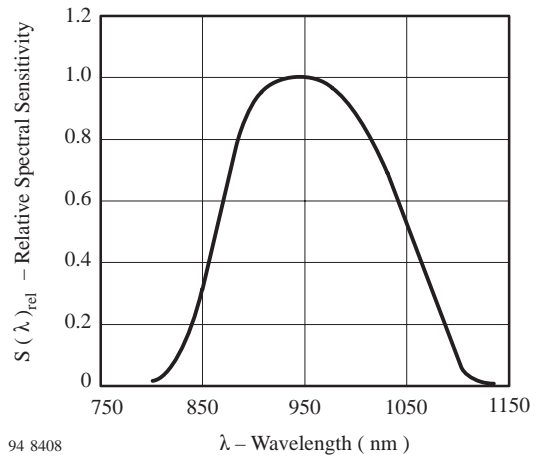

94 8408

Figure 11. Relative Spectral Sensitivity vs. Wavelength

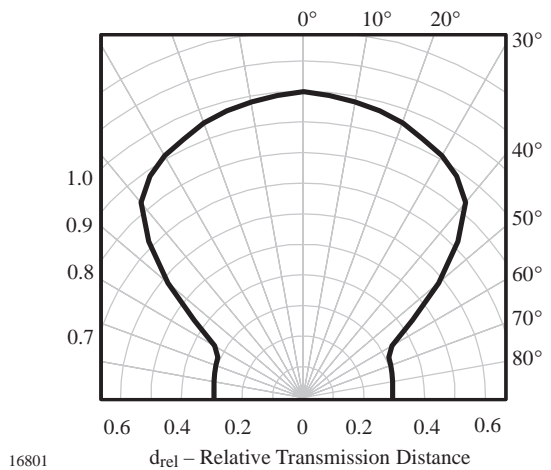

16801

Figure 12. Directivity

Operating Instructions

Reflow Soldering

- Reflow soldering must be done within 48 hours stored under max. 30°C, 80% RH after opening envelop
- Recommended soldering paste (composition: SN 63%, Pb 37%)
Melting temperature 178 to 192°C
- Apply solder paste to the specified soldering pads, by using a dispenser or by screen printing.
- Recommended thickness of metal mask is 0.2 mm for screen printing.
- The recommended reflow furnace is a combination type with upper and lower heaters.
- Set the furnace temperatures for pre-heating and heating in accordance with the reflow temperature profile as shown below. Exercise extreme care to keep the maximum temperature below 230°C. The following temperature profile means the temperature at the device surface. Since temperature difference occurs between the work and the surface of the circuit board depending on the position of circuit board or reflow furnace, the operating conditions should be verified prior to start of operation.
- Handling after reflow should be done only after the work surface has been cooled off.

Manual Soldering

- Use the 6/4 solder or the solder containing silver.
- Use a soldering iron of 25 W or smaller. Adjust the temperature of the soldering iron below 300°C.
- Finish soldering within three seconds.
- Handle products only after the temperature is cooled off.

Cleaning

- Perform cleaning after soldering strictly in conformance to the following conditions:
Cleaning agent:
2-propanol (isopropyl alcohol).
Commercially available grades (industrial use) should be used.
Demineralized or distilled water having a resistivity of not less than 500 mΩ corresponding to a conductivity of 2 mS/m.
- Temperature and time: 30 seconds under the temperature below 50°C or 3 minutes below 30°C.
- Ultrasonic cleaning: Below 20 W.

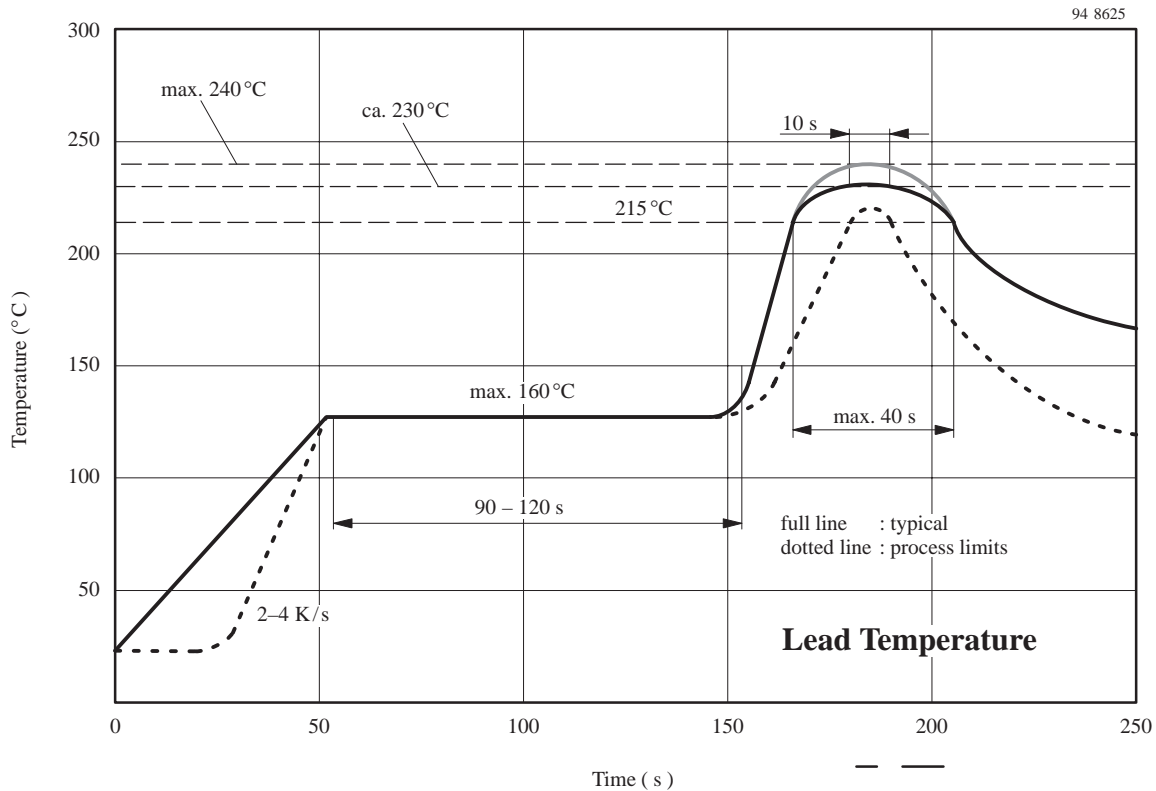

Dimensions in mm

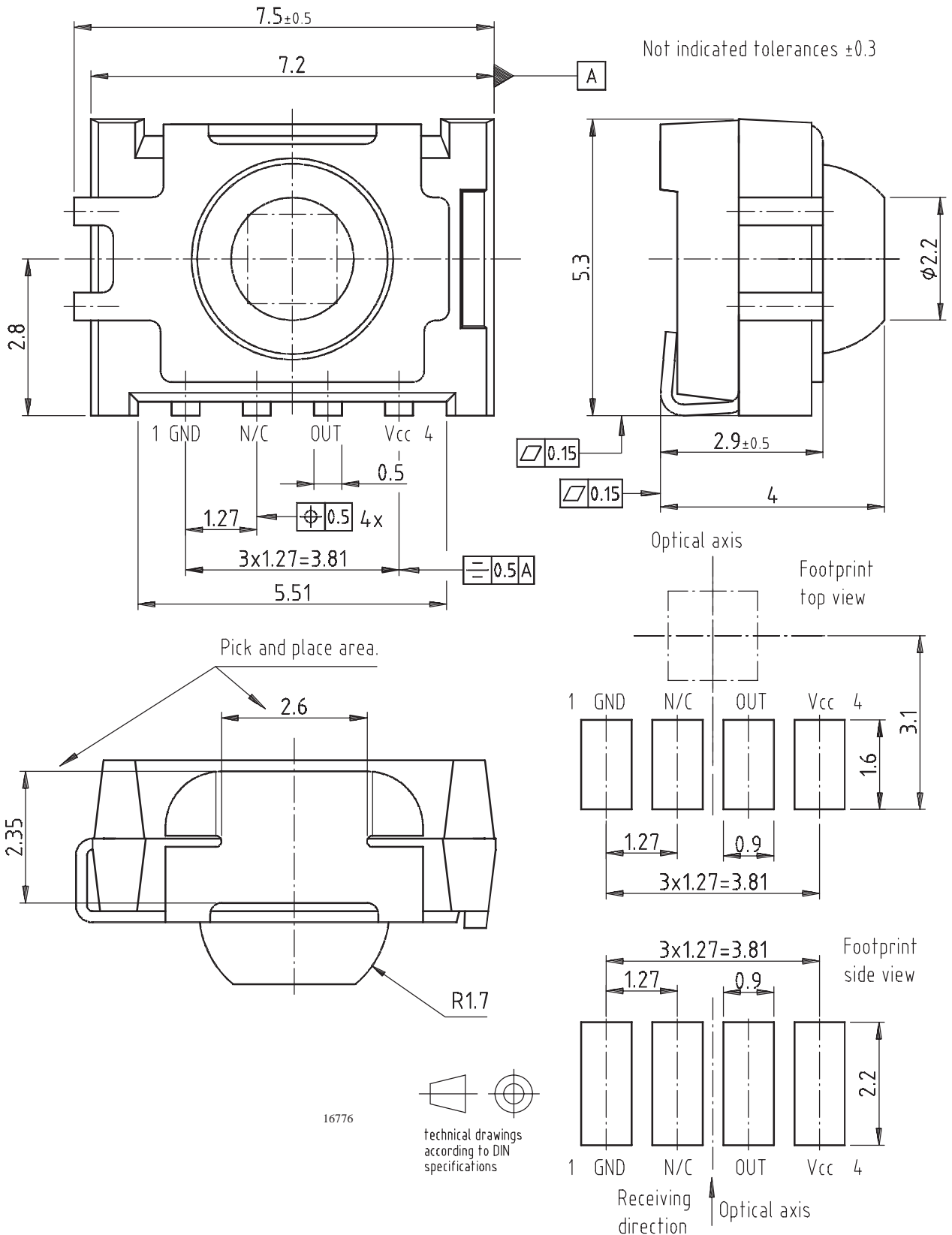

Ozone Depleting Substances Policy Statement

It is the policy of **Vishay Semiconductor GmbH** to

1. Meet all present and future national and international statutory requirements.
2. Regularly and continuously improve the performance of our products, processes, distribution and operating systems with respect to their impact on the health and safety of our employees and the public, as well as their impact on the environment.

It is particular concern to control or eliminate releases of those substances into the atmosphere which are known as ozone depleting substances (ODSs).

The Montreal Protocol (1987) and its London Amendments (1990) intend to severely restrict the use of ODSs and forbid their use within the next ten years. Various national and international initiatives are pressing for an earlier ban on these substances.

Vishay Semiconductor GmbH has been able to use its policy of continuous improvements to eliminate the use of ODSs listed in the following documents.

1. Annex A, B and list of transitional substances of the Montreal Protocol and the London Amendments respectively
2. Class I and II ozone depleting substances in the Clean Air Act Amendments of 1990 by the Environmental Protection Agency (EPA) in the USA
3. Council Decision 88/540/EEC and 91/690/EEC Annex A, B and C (transitional substances) respectively.

Vishay Semiconductor GmbH can certify that our semiconductors are not manufactured with ozone depleting substances and do not contain such substances.

We reserve the right to make changes to improve technical design and may do so without further notice.

Parameters can vary in different applications. All operating parameters must be validated for each customer application by the customer. Should the buyer use Vishay-Telefunken products for any unintended or unauthorized application, the buyer shall indemnify Vishay-Telefunken against all claims, costs, damages, and expenses, arising out of, directly or indirectly, any claim of personal damage, injury or death associated with such unintended or unauthorized use.

Vishay Semiconductor GmbH, P.O.B. 3535, D-74025 Heilbronn, Germany
Telephone: 49 (0)7131 67 2831, Fax number: 49 (0)7131 67 2423