

HIGH EFFICIENCY FAST RECOVERY RECTIFIER DIODES

MAIN PRODUCT CHARACTERISTICS

I_{F(AV)}	3A
V_{RRM}	200 V
T_j (max)	150 °C
V_F (max)	0.85 V
t_{rr} (max)	35 ns

FEATURES AND BENEFITS

- VERY LOW CONDUCTION LOSSES
- NEGLIGIBLE SWITCHING LOSSES
- LOW FORWARD AND REVERSE RECOVERY TIMES

DESCRIPTION

Low voltage drop and rectifier suited for switching mode base drive and transistor circuits.

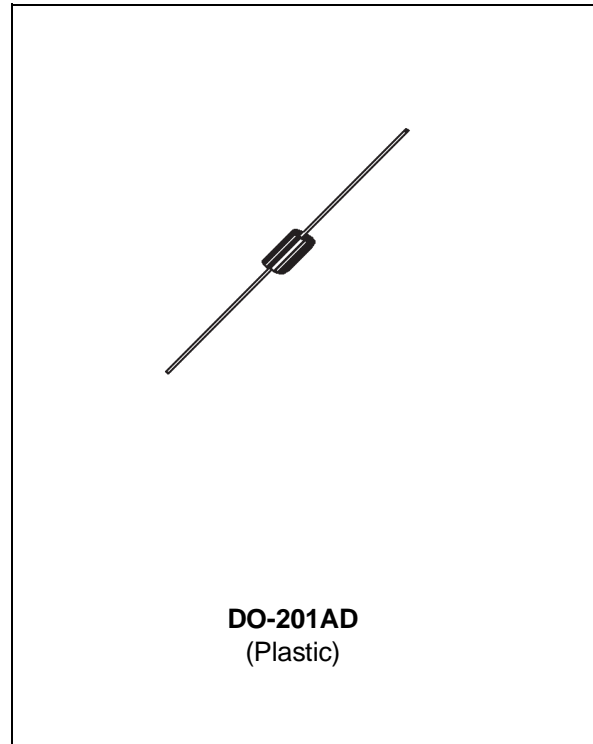

ABSOLUTE RATINGS (limiting values)

Symbol	Parameter		Value	Unit
V _{RRM}	Repetitive peak reverse voltage		200	V
I _{FRM}	Repetitive peak forward current *	t _p =5 μs F=1KHz	110	A
I _{F(AV)}	Average forward current*	T _a = 75°C δ = 0.5	3	A
I _{FSM}	Surge non repetitive forward current	t _p = 10ms Sinusoidal	70	A
T _{stg}	Storage temperature range		- 65 to + 150	°C
T _j	Maximum operating junction temperature		150	°C
T _L	Maximum lead temperature for soldering during 10s at 4mm from case		230	°C

* On infinite heatsink with 10mm lead length.

BYW98-200

THERMAL RESISTANCE

Symbol	Parameter	Value	Unit
Rth (j-a)	Junction-ambient *	25	°C/W

* On infinite heatsink with 10mm lead length.

STATIC ELECTRICAL CHARACTERISTICS

Symbol	Parameter	Test Conditions	Min.	Typ.	Max.	Unit	
I _R *	Reverse leakage current	T _j = 25°C	V _R = V _{RRM}			10	μA
		T _j = 100°C				0.5	mA
V _F **	Forward voltage drop	T _j = 25°C	I _F = 9A			1.2	V
		T _j = 100°C	I _F = 3A		0.78	0.85	

Pulse test : * tp = 5 ms, δ < 2 %

** tp = 380 μs, δ < 2 %

To evaluate the conduction losses use the following equations:

$$P = 0.75 \times I_F(AV) + 0.04 I_F^2(RMS)$$

RECOVERY CHARACTERISTICS

Symbol	Test Conditions	Min.	Typ.	Max.	Unit
t _{rr}	T _j = 25°C I _F = 1A dI _F /dt = - 50A/μs V _R = 30V			35	ns
Q _{rr}	T _j = 25°C I _F = 3A dI _F /dt = - 20A/μs V _R ≤ 30V		15		nC
t _{fr}	T _j = 25°C I _F = 3A dI _F /dt = - 50A/μs Measured at 1.1 x V _F max		20		ns
V _{FP}	T _j = 25°C I _F = 3A dI _F /dt = - 50A/μs		5		V

Fig. 1: Average forward power dissipation versus average forward current.

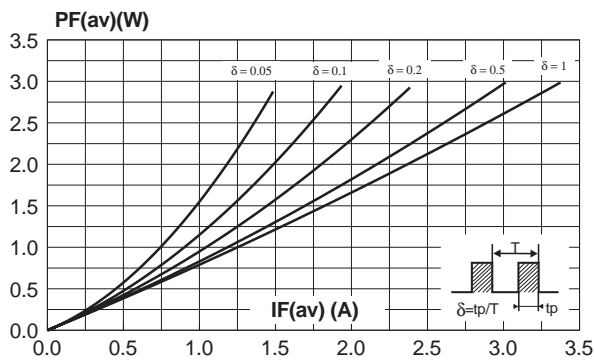

Fig. 2: Average forward current versus ambient temperature ($\delta=0.5$).

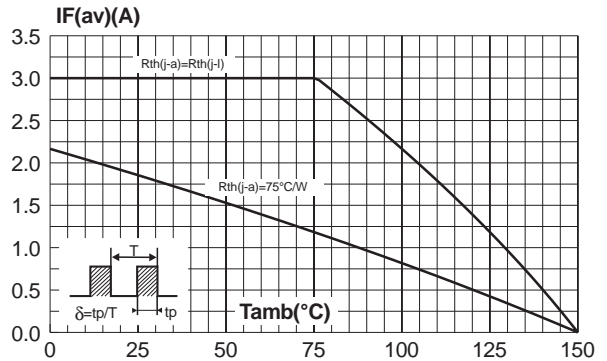

Fig. 3: Thermal resistance versus lead length.

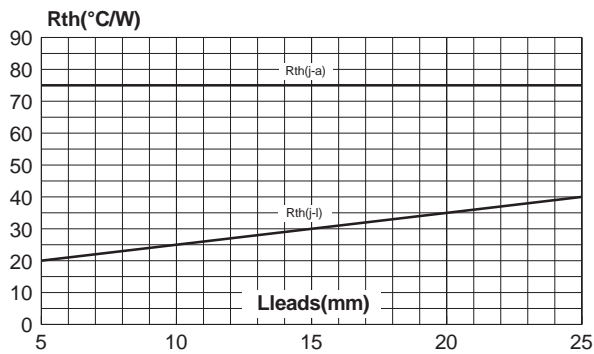

Fig. 4: Variation of thermal impedance junction to ambient versus pulse duration (recommended pad layout, epoxy FR4, $e(\text{Cu})=35\mu\text{m}$).

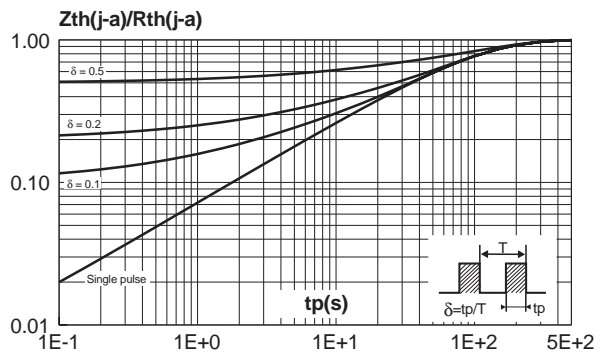

Fig. 5: Forward voltage drop versus forward current (maximum values).

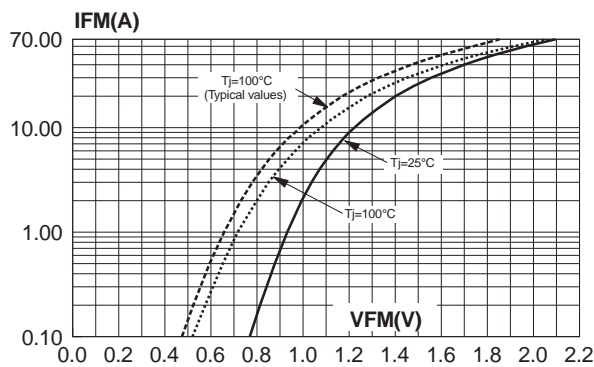

Fig. 6: Junction capacitance versus reverse voltage applied (typical values).

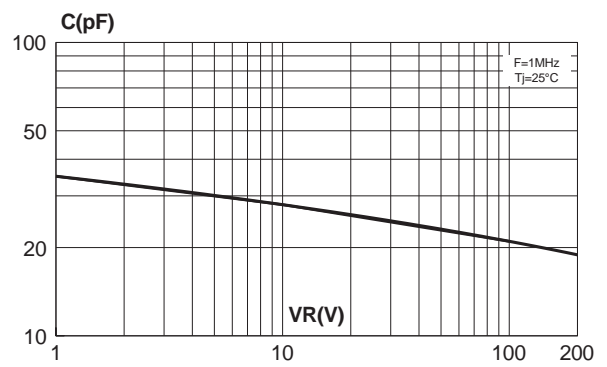

Fig. 7: Reverse recovery time versus dI_F/dt .

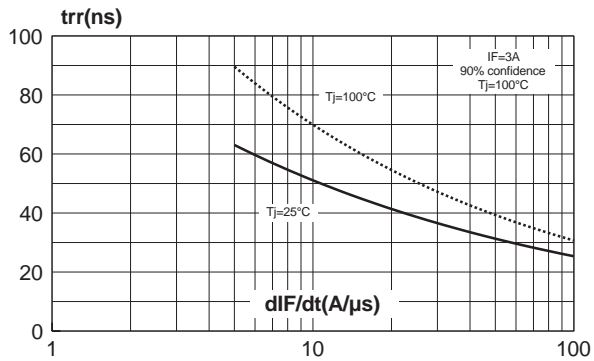

Fig. 8: Peak reverse recovery current versus dI_F/dt .

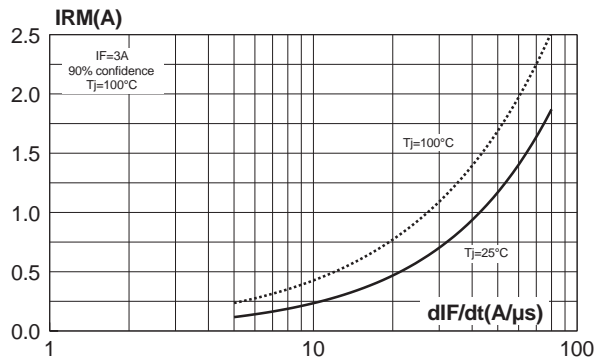
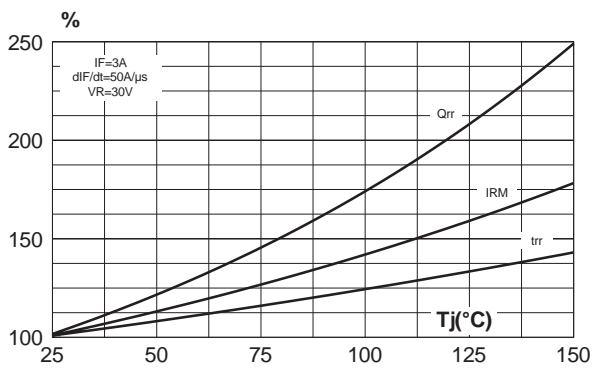
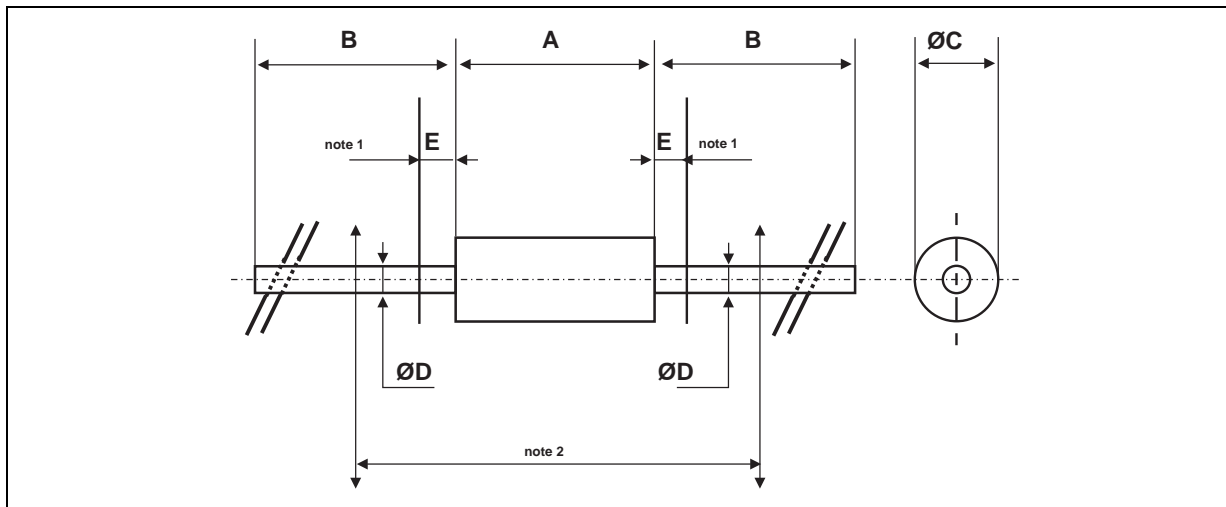

Fig. 9: Dynamic parameters versus junction temperature.



PACKAGE MECHANICAL DATA

DO-201AD



REF.	DIMENSIONS				NOTES
	Millimeters		Inches		
	Min.	Max.	Min.	Max.	
A		9.50		0.374	1 - The lead diameter $\varnothing D$ is not controlled over zone E 2 - The minimum axial length within which the device may be placed with its leads bent at right angles is 0.59" (15 mm)
B	25.40		1.000		
$\varnothing C$		5.30		0.209	
$\varnothing D$		1.30		0.051	
E		1.25		0.049	

Ordering code	Marking	Package	Weight	Base qty	Delivery mode
BYW98-200	BYW98-200	DO-201AD	1.16 g.	600	Box
BYW98-200RL	BYW98-200	DO-201AD	1.16 g.	1900	Tape and reel

- White band indicates cathode
- Epoxy meets UL94,V0

Information furnished is believed to be accurate and reliable. However, STMicroelectronics assumes no responsibility for the consequences of use of such information nor for any infringement of patents or other rights of third parties which may result from its use. No license is granted by implication or otherwise under any patent or patent rights of STMicroelectronics. Specifications mentioned in this publication are subject to change without notice. This publication supersedes and replaces all information previously supplied. STMicroelectronics products are not authorized for use as critical components in life support devices or systems without express written approval of STMicroelectronics.

The ST logo is a registered trademark of STMicroelectronics

© 1999 STMicroelectronics - Printed in Italy - All rights reserved.

STMicroelectronics GROUP OF COMPANIES

Australia - Brazil - China - Finland - France - Germany - Hong Kong - India - Italy - Japan - Malaysia
Malta - Morocco - Singapore - Spain - Sweden - Switzerland - United Kingdom - U.S.A.

<http://www.st.com>