

LC ARGUS® LED Low current 3 mm (T1) LED, Non Diffused

LS K389, LY K389, LG K389

Besondere Merkmale

- eingefärbtes, klares Gehäuse
- Kunststoffgehäuse mit spezieller Formgebung
- hohe Lichtstärke bei kleinen Strömen (typ. 2 mA)
- bei Einsatz eines äußeren Reflectors zur Hintergrundbeleuchtung von Leuchtfeldern und LCD-Anzeigen geeignet.
- zur Direkteinkopplung in Lichtleiterflächen geeignet
- gleichmäßige Ausleuchtung einer Streuscheibe (Weißdruck) vor dem äußeren Reflektor
- Lötspieße mit Aufsetzebene
- gegurtet lieferbar
- Störimpulsfest nach DIN 40839
- **Hinweis:** Bei farbigen Streuscheiben muß die spektrale Transmission an die, von der LED emittierte Wellenlänge angepaßt werden.

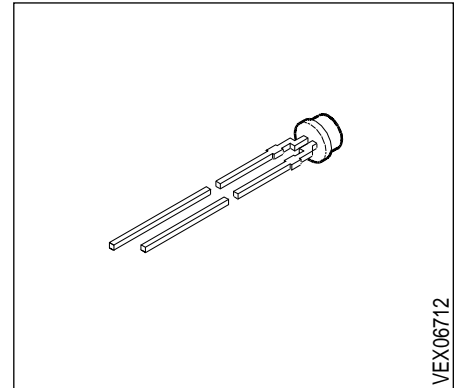

Features

- colored, clear package
- plastic package with a special design
- high light intensity at low currents (typ. 2 mA)
- in connection with an additional, custom built reflector suitable for backlighting of display panels
- for optical coupling into light pipes
- uniform illumination of a diffuser screen in front of the custom built reflector
- solder leads with stand-off
- available taped on reel
- load dump resistant acc. to DIN 40839
- **Note:** If the diffuser screen is tinted, the spectral transmission must be adjusted to the wavelength emitted by the LED.

Typ Type	Emissionsfarbe Color of Emission	Gehäusefarbe Color of Package	Lichtstrom Luminous Flux $I_F = 2 \text{ mA}$ $\Phi_V \text{ (mlm)}$	Bestellnummer Ordering Code
LS K389-FO	super-red	red clear	≥ 1 (5.0 typ.)	Q62703-Q1771
LY K389-FO	yellow	yellow clear	≥ 1 (3.2 typ.)	Q62703-Q1772
LG K389-FO	green	green clear	≥ 1 (3.2 typ.)	Q62703-Q1773

Streuung des Lichtstromes in einer Verpackungseinheit $\Phi_{V \max} / \Phi_{V \min} \leq 2.0$.

Luminous flux ratio in one packaging unit $\Phi_{V \max} / \Phi_{V \min} \leq 2.0$.

Grenzwerte Maximum Ratings

Bezeichnung Parameter	Symbol Symbol	Werte Values	Einheit Unit
Betriebstemperatur Operating temperature range	T_{op}	- 55 ... + 100	°C
Lagertemperatur Storage temperature range	T_{stg}	- 55 ... + 100	°C
Sperrschichttemperatur Junction temperature	T_j	+ 100	°C
Durchlaßstrom Forward current	I_F	7.5	mA
Stoßstrom Surge current $t \leq 10 \mu s, D = 0.005$	I_{FM}	150	mA
Sperrspannung Reverse voltage	V_R	5	V
Verlustleistung Power dissipation $T_A \leq 25 \text{ °C}$	P_{tot}	20	mW
Wärmewiderstand Thermal resistance Sperrschicht / Luft Junction / air	$R_{th JA}$	500	K/W

Kennwerte ($T_A = 25\text{ °C}$)

Characteristics

Bezeichnung Parameter	Symbol Symbol	Werte Values			Einheit Unit
		LS	LY	LG	
Wellenlänge des emittierten Lichtes (typ.) Wavelength at peak emission (typ.) $I_F = 7.5\text{ mA}$	λ_{peak}	635	586	565	nm
Dominantwellenlänge (typ.) Dominant wavelength (typ.) $I_F = 7.5\text{ mA}$	λ_{dom}	628	590	570	nm
Spektrale Bandbreite bei 50 % $\Phi_{\text{rel max}}$ (typ.) Spectral bandwidth at 50 % $\Phi_{\text{rel max}}$ (typ.) $I_F = 7.5\text{ mA}$	$\Delta\lambda$	45	45	25	nm
Durchlaßspannung (typ.) Forward voltage (max.) $I_F = 2\text{ mA}$	V_F V_F	1.8 2.6	2.0 2.7	1.9 2.6	V V
Sperrstrom (typ.) Reverse current (max.) $V_R = 5\text{ V}$	I_R I_R	0.01 10	0.01 10	0.01 10	μA μA
Kapazität (typ.) Capacitance $V_R = 0\text{ V}, f = 1\text{ MHz}$	C_0	3	3	15	pF
Schaltzeiten: Switching times: I_V from 10 % to 90 % (typ.) I_V from 90 % to 10 % (typ.) $I_F = 100\text{ mA}, t_p = 10\text{ }\mu\text{s}, R_L = 50\text{ }\Omega$	t_r t_f	200 150	200 150	450 200	ns ns

Relative spektrale Emission $\Phi_{rel} = f(\lambda)$, $T_A = 25\text{ °C}$, $I_F = 7.5\text{ mA}$

Relative spectral emission

$V(\lambda)$ = spektrale Augenempfindlichkeit

Standard eye response curve

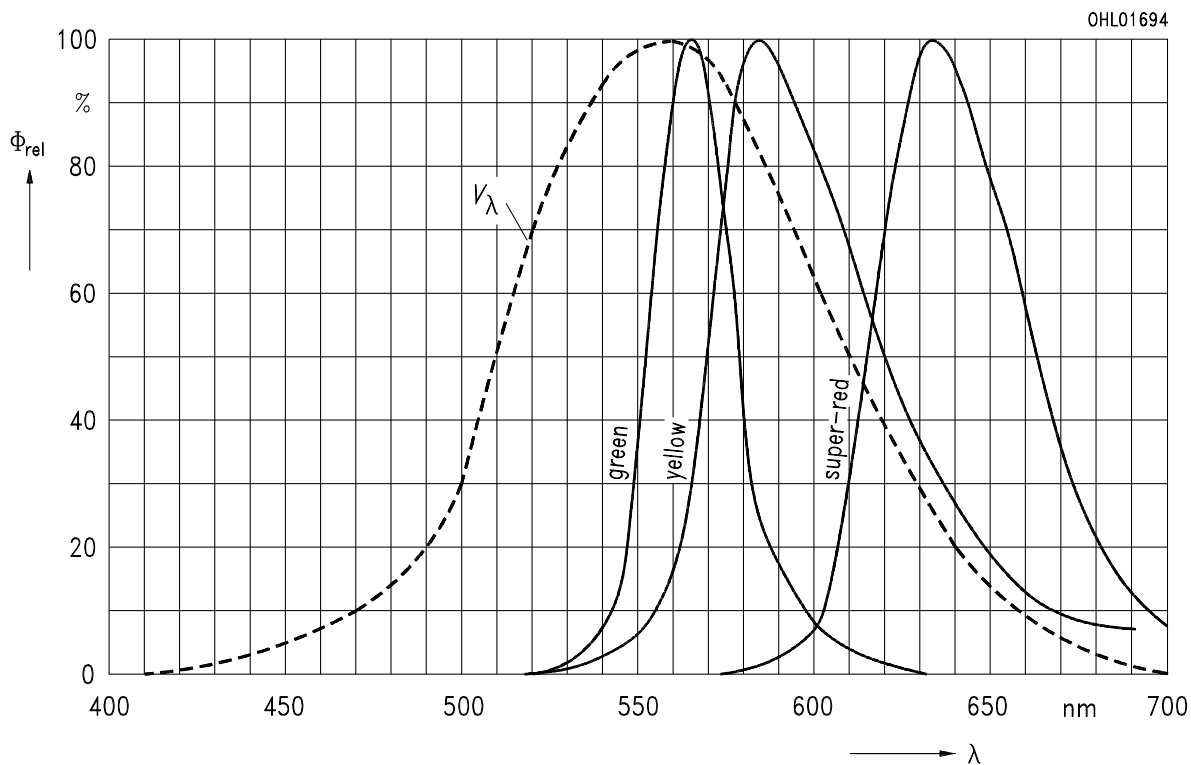

Abstrahlcharakteristik $\Phi_{rel} = f(\varphi)$

Radiation characteristic

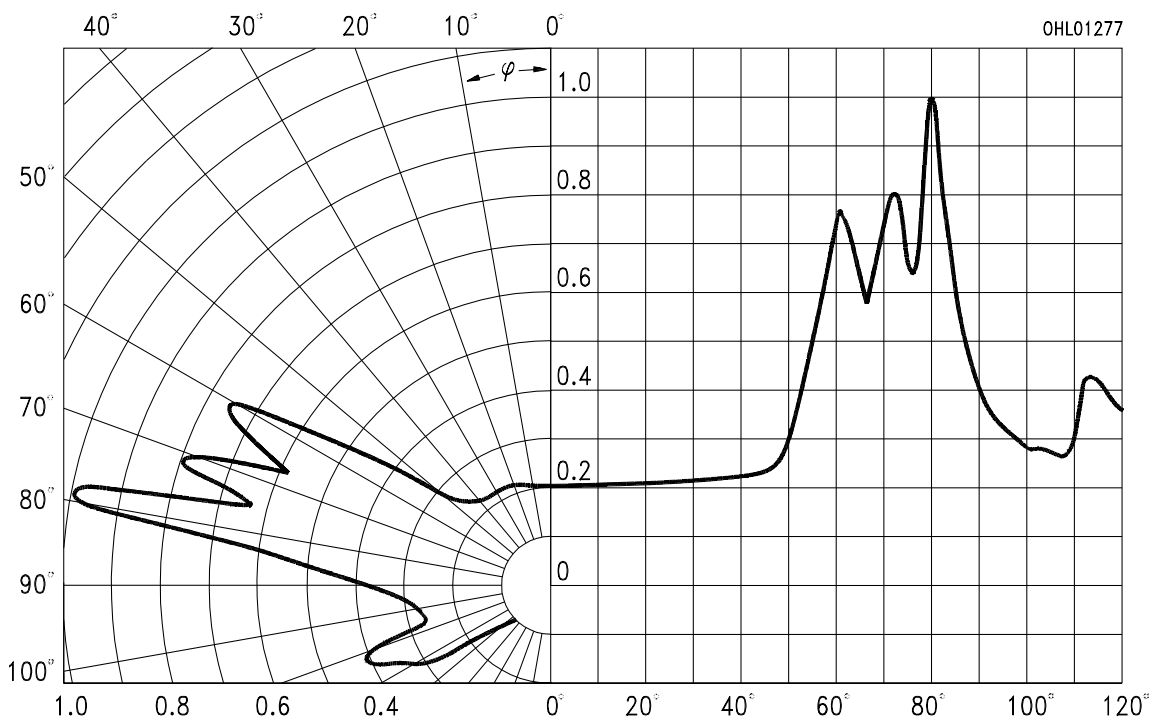

Durchlaßstrom $I_F = f(V_F)$

Forward current

$T_A = 25^\circ\text{C}$

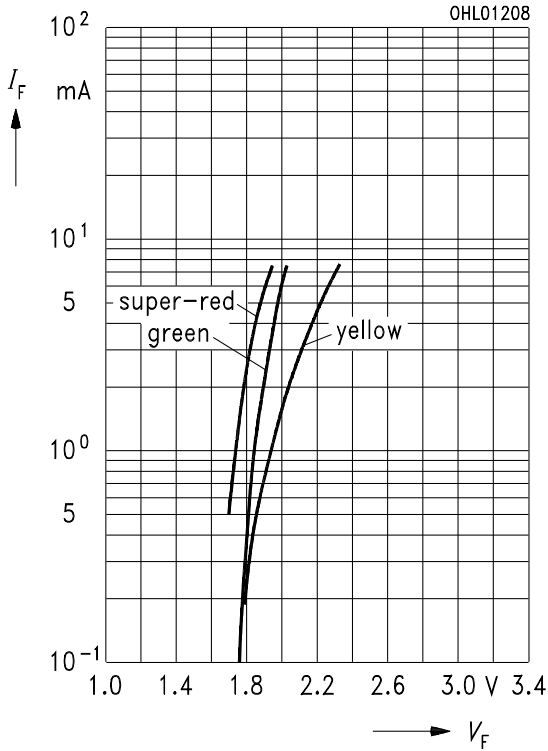

Relativer Lichtstrom $\Phi_V/\Phi_{V(2\text{ mA})} = f(I_F)$

Relative luminous flux

$T_A = 25^\circ\text{C}$

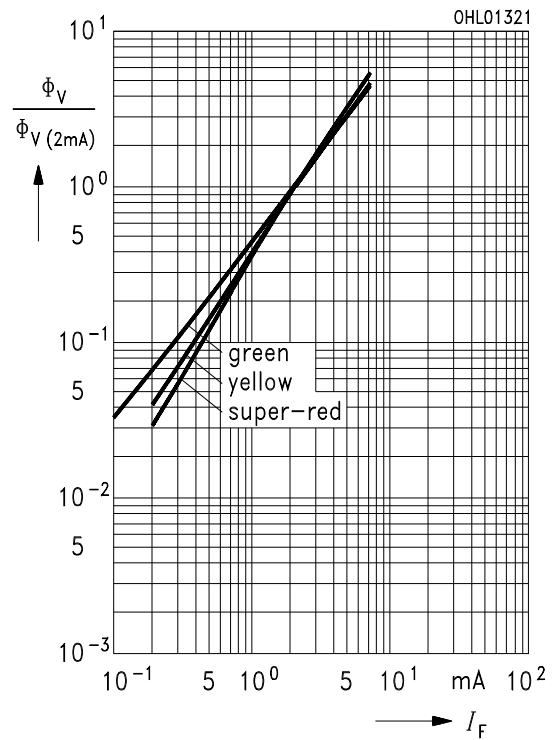

Zulässige Impulsbelastbarkeit $I_F = f(t_p)$

Permissible pulse handling capability

Duty cycle $D = \text{parameter}$, $T_A = 25^\circ\text{C}$

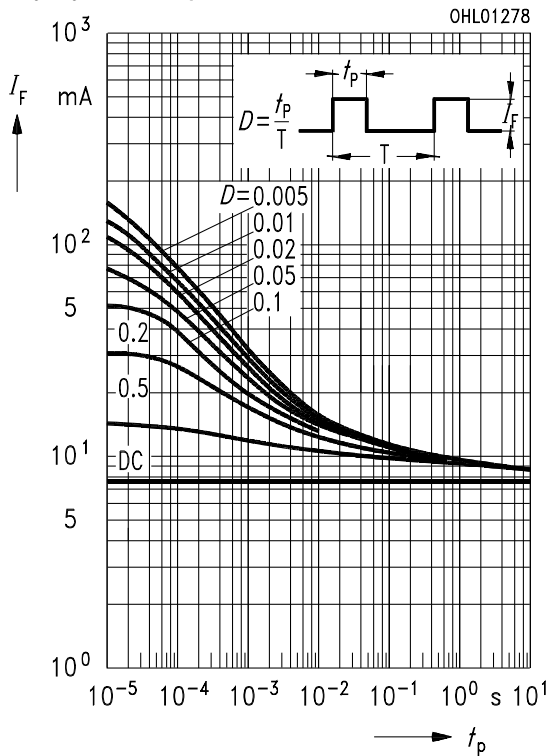

Maximal zulässiger Durchlaßstrom

Max. permissible forward current

$I_F = f(T_A)$

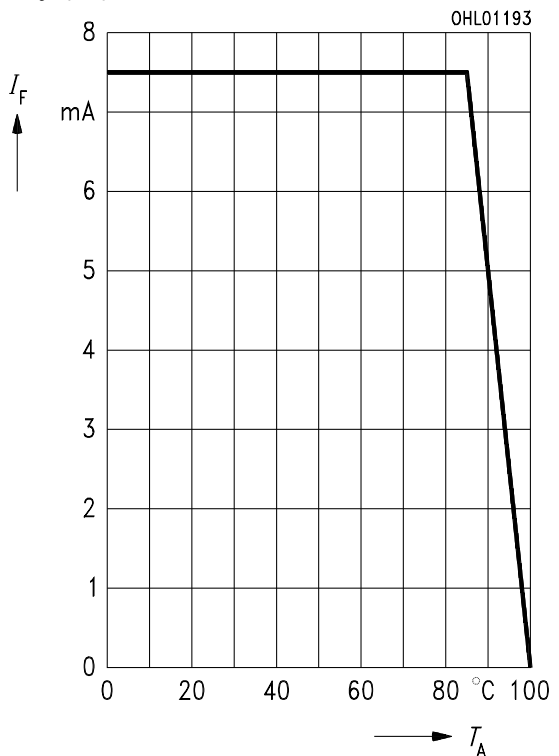

Wellenlänge der Strahlung $\lambda_{\text{peak}} = f(T_A)$
Wavelength at peak emission

$I_F = 7.5 \text{ mA}$

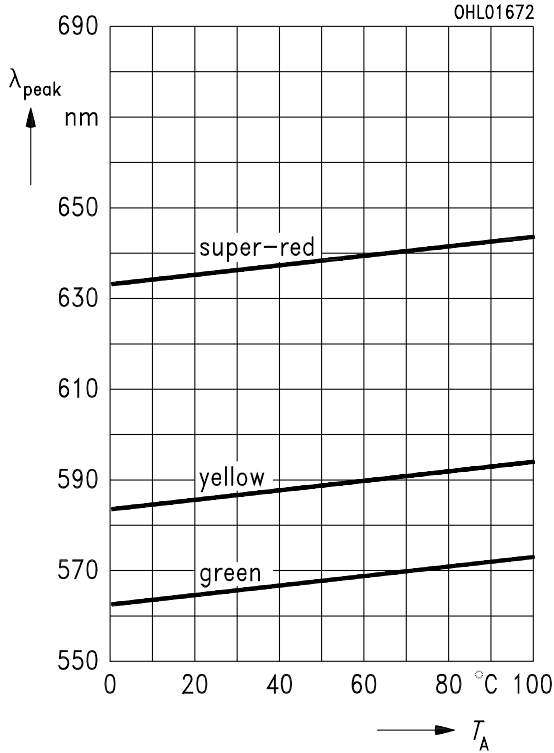

Dominantwellenlänge $\lambda_{\text{dom}} = f(T_A)$
Dominant wavelength

$I_F = 7.5 \text{ mA}$

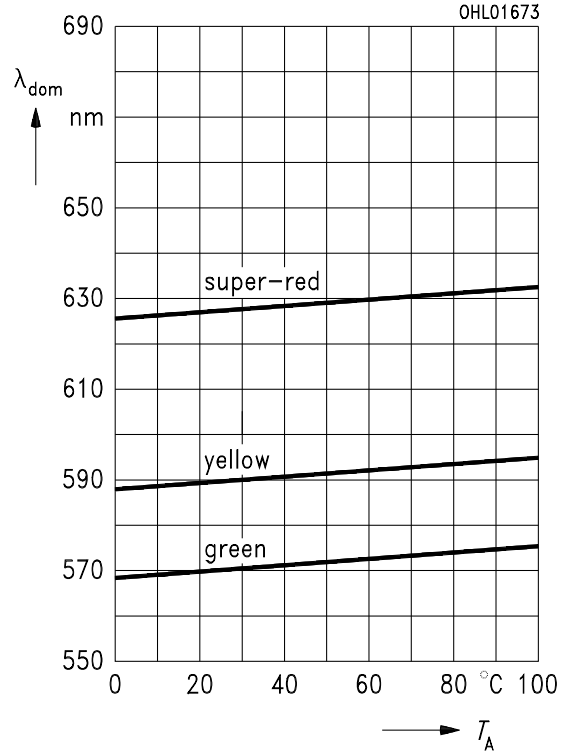

Durchlaßspannung $V_F = f(T_A)$
Forward voltage

$I_F = 2 \text{ mA}$

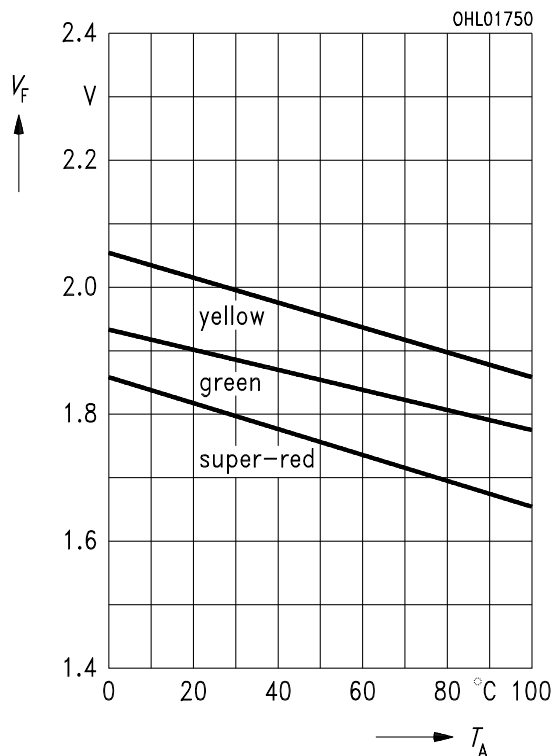

Relativer Lichtstrom $\Phi_V / \Phi_{V(25^\circ\text{C})} = f(T_A)$
Relative luminous flux

$I_F = 2 \text{ mA}$

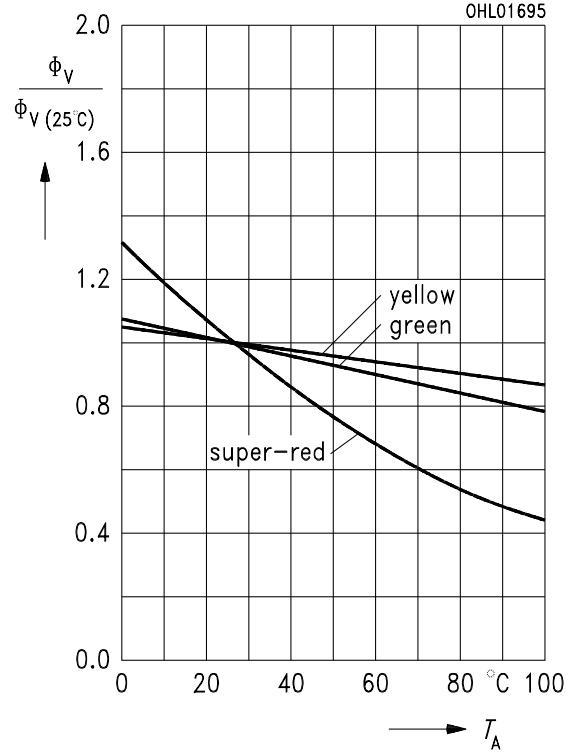

Maßzeichnung (Maße in mm, wenn nicht anders angegeben)
Package Outlines (Dimensions in mm, unless otherwise specified)

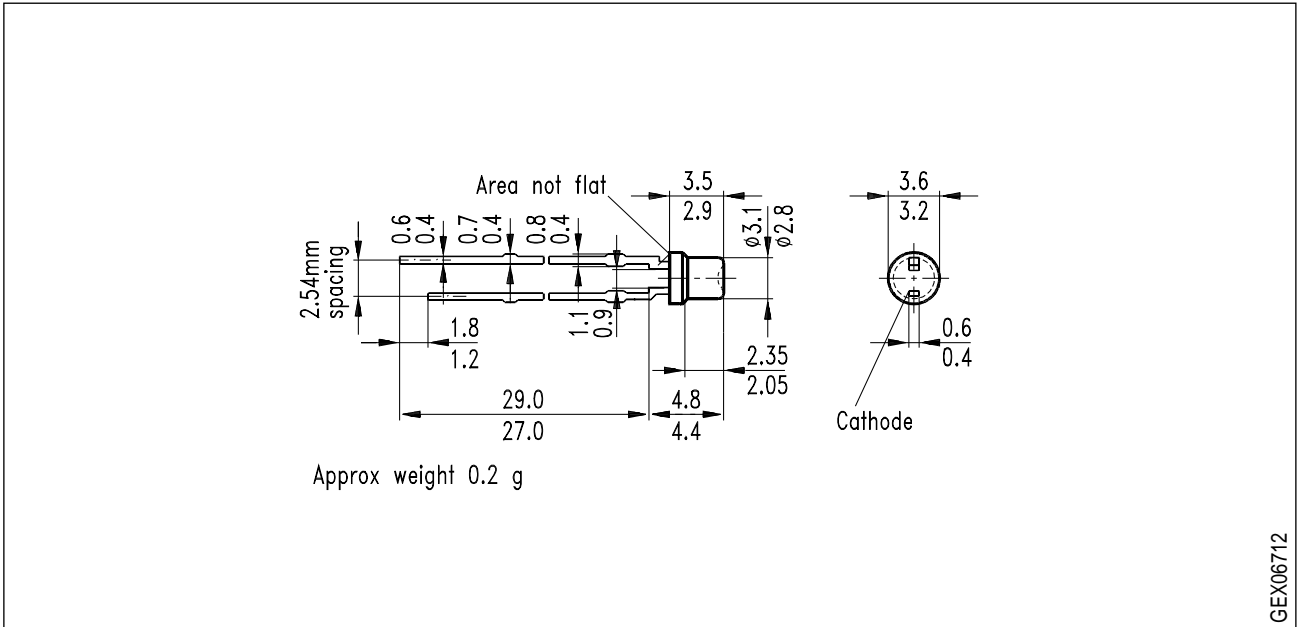

Kathodenkennzeichnung: Kürzerer Lötspieß
Cathode mark: Short solder lead