



# MIC5312

## LowQ™ Mode Dual 300mA LDO with Integrated POR

### General Description

The MIC5312 is a high performance, dual  $\mu$ Cap low dropout regulator with integrated power-on reset supervisor, offering ultra-low operating current and a second, even lower operating current mode, LowQ™ mode, reducing operating current by 75%. Each regulator can source up to 300mA of output current maximum.

Ideal for battery operated applications, the MIC5312 offers 1% accuracy, extremely low dropout voltage (60mV @ 150mA), and low ground current (typically 28 $\mu$ A total). When put into LowQ™ mode, the internal current draw drops down to 7 $\mu$ A total. The MIC5312 also comes equipped with a TTL logic compatible enable pin that allows the part to be put into a zero-off-mode current state, drawing no current when disabled.

The Power-on Reset is active low and indicates an output undervoltage condition on either regulator 1 or 2 when the regulator is enabled.

The MIC5312 is a  $\mu$ Cap design, operating with very small ceramic output capacitors for stability, reducing required board space and component cost.

The MIC5312 is available in fixed output voltages in the 3mm x 3mm MLF-10 leadless package. Data sheets and support documentation can be found on Micrel's web site at [www.micrel.com](http://www.micrel.com).

### Features

- Input voltage range: 2.5V to 5.5V
- LowQ™ Mode
  - 7 $\mu$ A total quiescent current
  - 10mA output current capable LowQ™ mode
  - Logic level control with external pin
- Stable with ceramic output capacitor
- 2 LDO Outputs – 300mA each
- Integrated Power-on Reset (POR) with adjustable delay time
- Tiny 3mm x 3mm MLF™-10 package
- Low dropout voltage of 60mV @ 150mA
- Ultra-low quiescent current of 28 $\mu$ A total in Full Current Mode
- High output accuracy
  - $\pm 1.0\%$  initial accuracy
  - $\pm 2.0\%$  over temperature
- Thermal Shutdown Protection
- Current Limit Protection

### Applications

- Cellular/PCS phones
- Wireless modems
- PDAs
- MP3 Players

### Typical Application

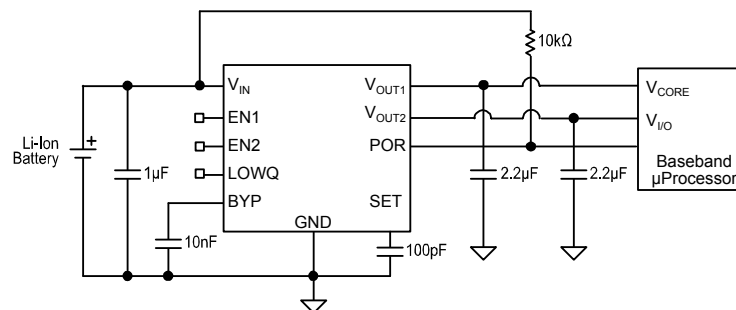

MIC5312-xxBML

MLF and MicroLeadFrame are trademarks of Amkor Technology, Inc.

Micrel Inc. • 2180 Fortune Drive • San Jose, CA 95131 • USA • tel +1 (408) 944-0800 • fax +1 (408) 474-1000 • <http://www.micrel.com>

## Ordering Information

| Part Number   | Output Voltage* | Junction Temp. Range | Package         |
|---------------|-----------------|----------------------|-----------------|
| MIC5312-GMBML | 1.8V/2.8V       | -40°C to +125°C      | 10-Pin 3×3 MLF™ |
| MIC5312-DKBML | 1.85V/2.6V      | -40°C to +125°C      | 10-Pin 3×3 MLF™ |

**Note:** \*Other Voltage options available between 1.25V and 5V. Contact Micrel for details.

## Pin Configuration

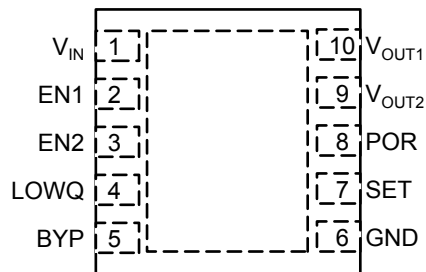

MIC5312-xxBML (3x3)

## Pin Description

| Fixed | Pin Name          | Pin Function   |
|-------|-------------------|--|
| 1     | V <sub>IN</sub>   | Supply Input. (V <sub>IN1</sub> and V <sub>IN2</sub> are internally tied together)   |
| 2     | EN1               | Enable Input (regulator 1). Active High Input. Logic High = On; Logic Low = Off; Do not leave floating   |
| 3     | EN2               | Enable Input (regulator 2). Active High Input. Logic High = On; Logic Low = Off; Do not leave floating   |
| 4     | LowQ™             | LowQ™ Mode. Active Low Input. Logic High = Full Power Mode; Logic Low = Light Load Mode; Do not leave floating.  |
| 5     | BYP               | Reference Bypass: Connect external 0.01μF to GND to reduce output noise. May be left open.   |
| 6     | GND               | Ground.  |
| 7     | SET               | Delay Set Input: Connect external capacitor to GND to set the internal delay for the POR output. When left open, there is no delay. This pin cannot be grounded. Delay = 1μs/1pF |
| 8     | POR               | Power-On Reset Output: Open-drain output. Active low indicates an output undervoltage condition on either regulator 1 or regulator 2 when device is enabled.                     |
| 9     | V <sub>OUT2</sub> | Output of regulator 2  |
| 10    | V <sub>OUT1</sub> | Output of regulator 1  |
| EP    | GND               | Ground. Internally connected to the Exposed Pad.   |

### Absolute Maximum Ratings<sup>(1)</sup>

Supply Input Voltage ( $V_{IN}$ )..... 0V to 6V  
 Enable Input Voltage ( $V_{EN}$ )..... 0V to 6V  
 LowQ™ Input Voltage ( $V_{LOWQ™}$ )..... 0V to 6V  
 Power Dissipation ( $P_D$ )..... Internally Limited <sup>(3)</sup>  
 Junction Temperature ..... -40°C to +125°C  
 Lead Temperature (soldering, 5sec.)..... 260°C  
 Storage Temperature ( $T_s$ ) ..... -65°C to +150°C

### Operating Ratings<sup>(2)</sup>

Supply Input Voltage ( $V_{IN}$ )..... 2.5V to 5.5V  
 Enable Input Voltage (EN1/EN2/LowQ™) ..... 0V to  $V_{IN}$   
 Junction Temperature ( $T_J$ ) ..... -40°C to +125°C  
 Package Thermal Resistance  
 MLF-10 ( $\theta_{JA}$ )..... 63°C/W

### Electrical Characteristics (Full Power Mode)

$V_{IN} = V_{OUT} + 1.0V$  for higher output of the regulator pair; LowQ™ =  $V_{IN}$ ;  $C_{OUT} = 2.2\mu F$ ,  $I_{OUT} = 100\mu A$ ;  $T_J = 25^\circ C$ , **bold** values indicate -40°C to +125, unless noted.

| Parameter                                     | Conditions  | Min         | Typ  | Max               | Units         |
|---|---|-------------|------|-------------------|---------------|
| Output Voltage Accuracy                       | Variation from nominal $V_{OUT}$                                    | -1.0        |      | +1.0              | %             |
|   | Variation from nominal $V_{OUT}$ ; -40°C to +125°C                  | <b>-2.0</b> |      | <b>+2.0</b>       | %             |
| Line Regulation                               | $V_{IN} = V_{OUT} + 1V$ to 5.5V                                     |             | 0.02 | 0.3<br><b>0.6</b> | %/V           |
| Load Regulation                               | $I_{OUT} = 100\mu A$ to 150mA                                       |             | 0.35 | <b>1.0</b>        | %             |
|   | $I_{OUT} = 100\mu A$ to 300mA                                       |             | 0.7  | <b>1.5</b>        | %             |
| Dropout Voltage                               | $I_{OUT} = 150mA$   |             | 60   |                   | mV            |
|   | $I_{OUT} = 300mA$   |             | 120  | <b>240</b>        | mV            |
| Ground Pin Current                            | $I_{OUT1} = I_{OUT2} = 100\mu A$ to 300mA                           |             | 28   | 45                | $\mu A$       |
|   |   |             |      | <b>50</b>         | $\mu A$       |
| Ground Pin Current in Shutdown                | $V_{EN} \leq 0.2V$  |             | 0.1  |                   | $\mu A$       |
| Ripple Rejection                              | $f =$ up to 1kHz; $C_{OUT} = 2.2\mu F$ ceramic; $C_{BYP} = 10nF$    |             | 65   |                   | dB            |
|   | $f = 1kHz - 20kHz$ ; $C_{OUT} = 2.2\mu F$ ceramic; $C_{BYP} = 10nF$ |             | 35   |                   | dB            |
| Current Limit                                 | $V_{OUT} = 0V$ (Both Regulators)                                    | 350         | 450  | 700               | mA            |
| Output Voltage Noise                          | $C_{OUT} = 2.2\mu F$ , $C_{BYP} = 0.01\mu F$ , 10Hz to 100kHz       |             | 45   |                   | $\mu V_{rms}$ |
| <b>Enable and LowQ™ Input (EN1/EN2/LowQ™)</b> |   |             |      |                   |               |
| Enable Input Voltage                          | Logic Low   |             |      | <b>0.2</b>        | V             |
|   | Logic High  | <b>1.0</b>  |      |                   | V             |
| Enable Input Current                          | $V_{IL} \leq 0.2V$  |             | 0.1  | <b>1</b>          | $\mu A$       |
|   | $V_{IH} \geq 1.0V$  |             | 0.1  | <b>1</b>          | $\mu A$       |
| Turn-on Time                                  | $C_{OUT} = 2.2\mu F$ ; $C_{BYP} = 0.01\mu F$                        |             | 300  | <b>500</b>        | $\mu s$       |
| <b>Light Load Response</b>                    |   |             |      |                   |               |
| Response Time <sup>(4)</sup>                  | Into Light Load   |             | 50   |                   | $\mu s$       |
|   | Out of Light Load   |             | 50   |                   | $\mu s$       |
| <b>POR Output</b>                             |   |             |      |                   |               |
| VTH   | Low Threshold, % of $V_{OUT}$ (Flag ON)                             | 90          |      |                   | %             |
|   | High Threshold, % of $V_{OUT}$ (Flag OFF)                           |             |      | 97                | %             |
| VOL   | POR Output Logic Low Voltage; $I_L = 250\mu A$                      |             | 0.01 | 0.1               | V             |
| IPOR  | Flag Leakage Current, Flag OFF                                      | -1          | 0.01 | +1                | $\mu A$       |
| <b>SET INPUT</b>                              |   |             |      |                   |               |
| SET Pin Current Source                        | $V_{SET} = 0V$  | 0.75        | 1.25 | 1.75              | $\mu A$       |
| SET Pin Threshold Voltage                     |   |             | 1.25 |                   | V             |

## Electrical Characteristics (LowQ™ Mode)

$V_{IN} = V_{OUT} + 1.0V$  for higher output of the regulator pair; LowQ™ = 0V;  $C_{OUT} = 2.2\mu F$ ,  $I_{OUT} = 100\mu A$ ;  $T_J = 25^\circ C$ , **bold** values indicate  $-40^\circ C$  to  $+125^\circ C$ , unless noted.

| Parameter                      | Conditions  | Min                 | Typ      | Max                 | Units              |
|--------------------------------|---|---------------------|----------|---------------------|--------------------|
| Output Voltage Accuracy        | Variation from nominal $V_{OUT}$  | -2.0<br><b>-3.0</b> |          | +2.0<br><b>+3.0</b> | %<br>%             |
| Line Regulation                | $V_{IN} = V_{OUT} + 1V$ to 5.5V   |                     | 0.02     | 0.3<br><b>0.6</b>   | %/V                |
| Load Regulation                | $I_{OUT} = 100\mu A$ to 10mA  |                     | 0.1      | <b>0.5</b>          | %                  |
| Dropout Voltage                | $I_{OUT} = 10mA$  |                     | 100      | <b>200</b>          | mV                 |
| Ground Pin Current             | Both outputs enabled  |                     | 7        | 10<br><b>12</b>     | $\mu A$<br>$\mu A$ |
| Ground Pin Current in Shutdown | $V_{EN} \leq 0.2V$  |                     | 0.01     | <b>1.0</b>          | $\mu A$            |
| Ripple Rejection               | $f =$ up to 1kHz; $C_{OUT} = 2.2\mu F$ ceramic; $C_{BYP} = 10nF$<br>$f = 1kHz - 20kHz$ ; $C_{OUT} = 2.2\mu F$ ceramic; $C_{BYP} = 10nF$ |                     | 45<br>30 |                     | dB<br>dB           |
| Current Limit                  | $V_{OUT} = 0V$ (Both regulators)  | <b>40</b>           | 75       | <b>150</b>          | mA                 |

### Notes:

1. Exceeding the absolute maximum rating may damage the device.
2. The device is not guaranteed to function outside its operating rating.
3. The maximum allowable power dissipation of any  $T_A$  (ambient temperature) is  $P_{D(max)} = T_{J(max)} - T_A / \theta_{JA}$ . Exceeding the maximum allowable power dissipation will result in excessive die temperature, and the regulator will go into thermal shutdown.
4. Response time defined as the minimum hold-off time after the LowQ™ command before applying load transients.

# Typical Characteristics

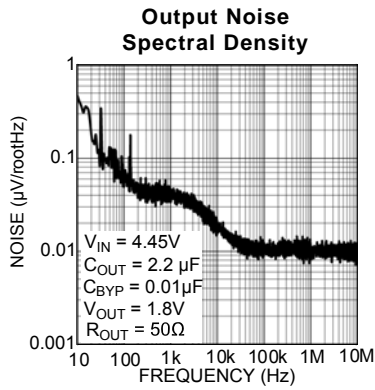
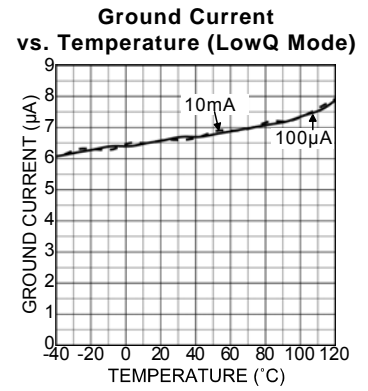
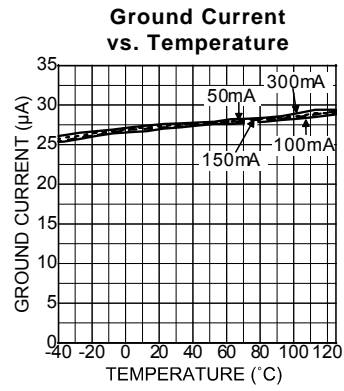
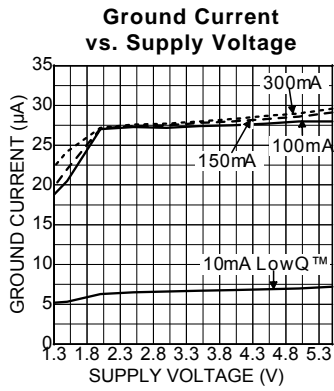
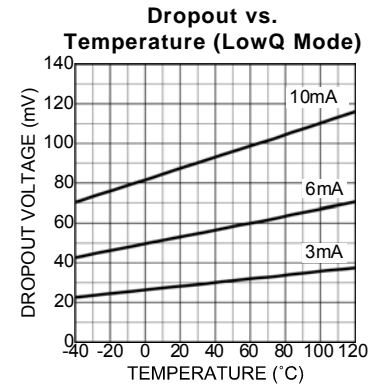
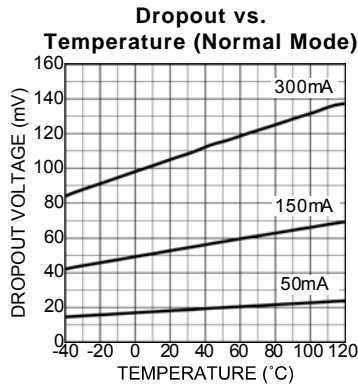
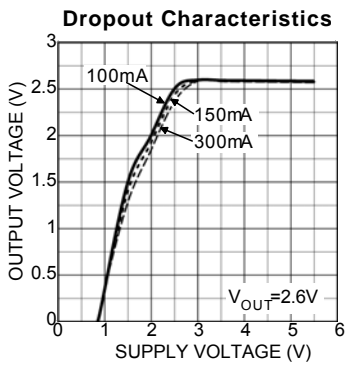
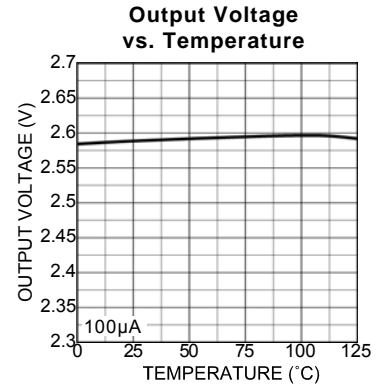
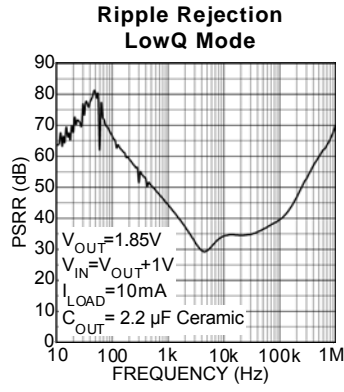
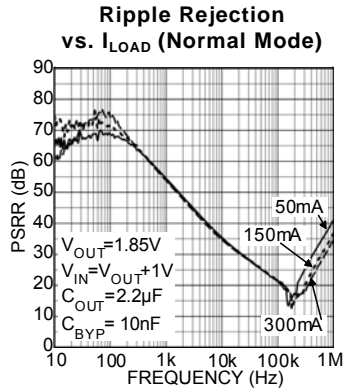

## Functional Characteristics

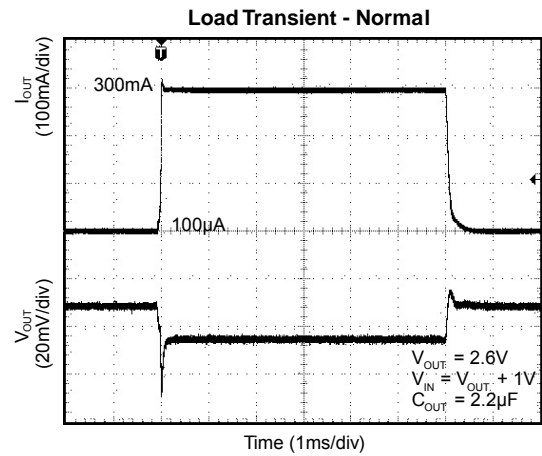
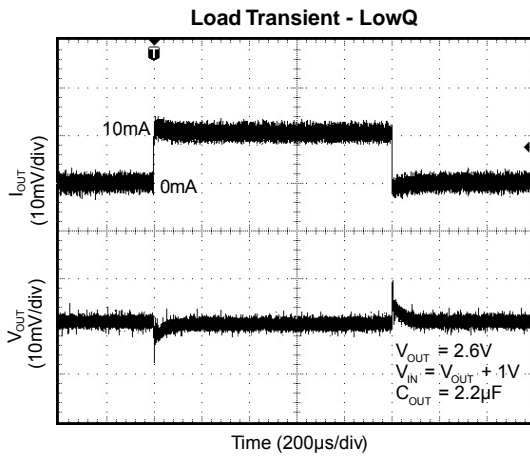
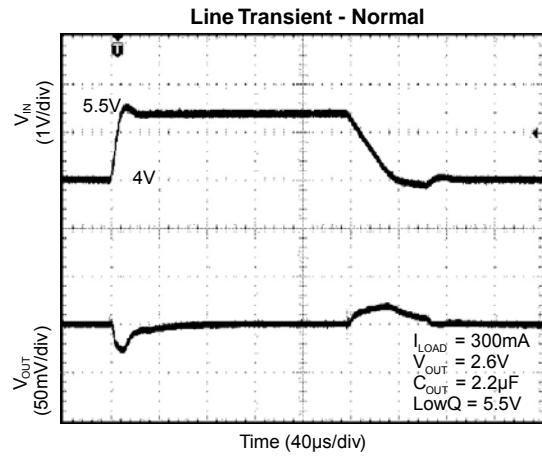
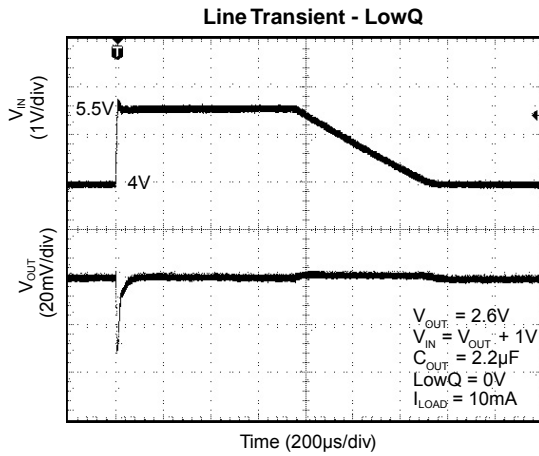
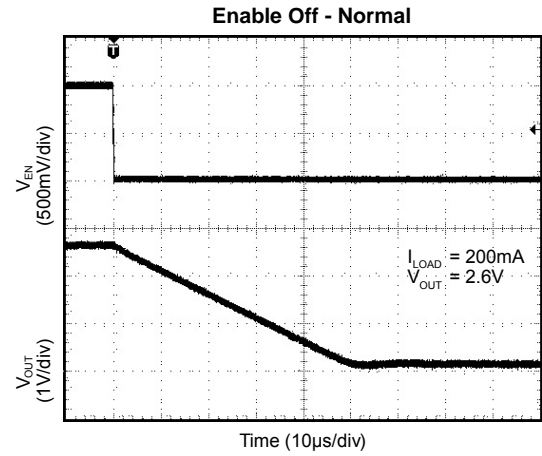
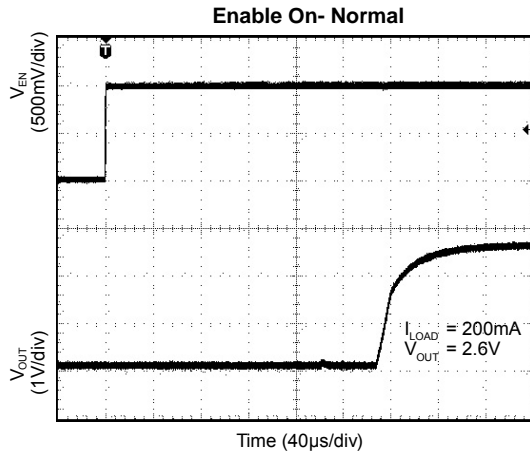

### Functional Characteristics (cont.)

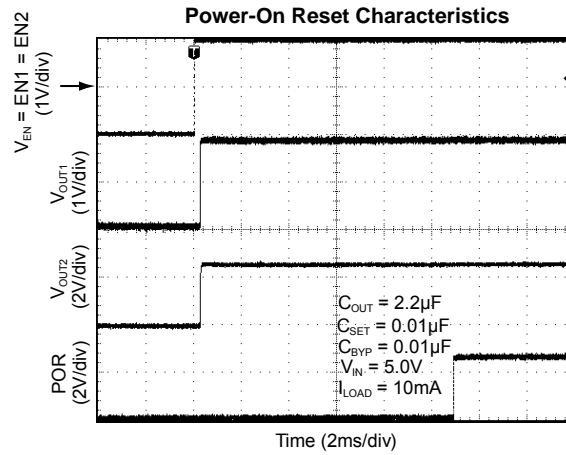
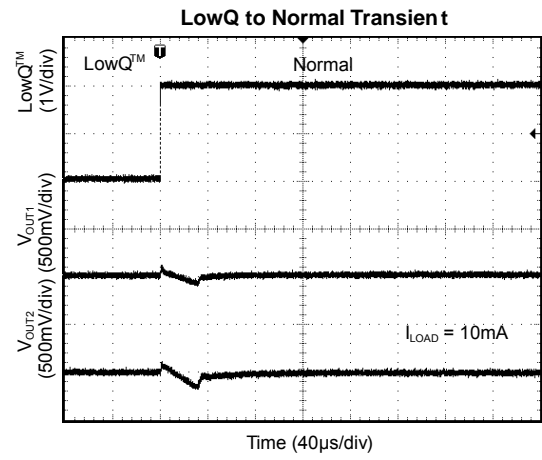
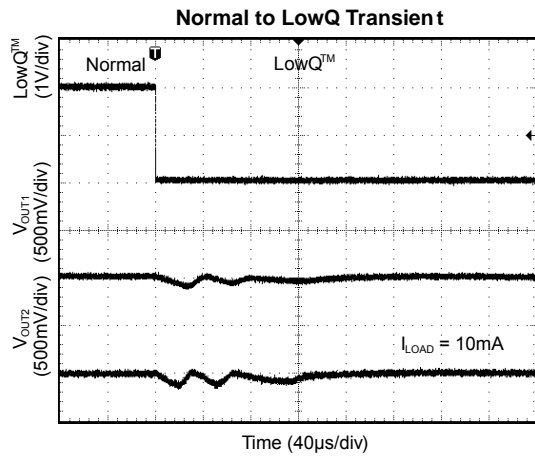

### Functional Diagram

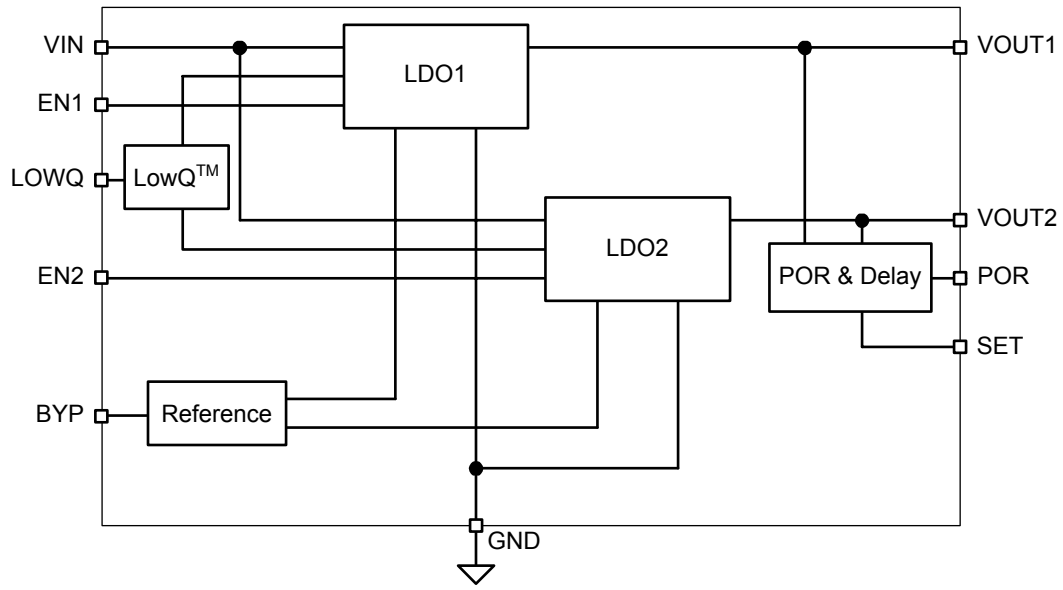

MIC5312 Block Diagram



## Functional Description

The MIC5312 is a high performance, low quiescent current power management IC consisting of two  $\mu$ Cap low dropout regulators with a LowQ™ mode featuring lower operating current. Both regulators are capable of sourcing 300mA. A POR circuit monitors both of the outputs and indicates when the output voltage is within 5% of nominal. The POR offers a delay time that is externally programmable with a single capacitor to ground.

### Enable 1 and 2

The enable inputs allow for logic control of both output voltages with individual enable inputs. The enable input is active high, requiring 1.0V for guaranteed operation. The enable input is CMOS logic and cannot be left floating.

There are two regulators in the MIC5312 that share a common bias. Each regulator can be enabled independently by setting the voltage on pins EN1 and EN2 to either logic high or low to turn the channel on or off. It is also possible to enable both channels by applying a voltage above 1.0V to both enable pins.

### Power-On Reset (POR)

The power-on reset output is an open-drain N-Channel device, requiring a pull-up resistor to either the input voltage or output voltage for proper voltage levels. The POR output has a delay time that is programmable with a capacitor from the SET pin to ground. The delay time can be programmed to be as long as 1 second.

The SET pin is a current source output that charges a capacitor that sets the delay time for the power-on reset output. The current source is a 1.25 $\mu$ A current source that charges a capacitor up from 0V. When the capacitor reaches 1.25V, the output of the POR is allowed to go high. The delay time in micro seconds is equal to the Cset in picofarads.

$$\text{POR Delay } (\mu\text{s}) = C_{\text{SET}} (\text{pF})$$

### LowQ™ Mode

The LowQ™ pin is logic level low, requiring <0.2V to enter the LowQ™ mode. The LowQ™ pin cannot be left floating. Features of the LowQ™ mode include lower total quiescent current of typically 7 $\mu$ A.

LowQ Mode can be used in many portable electronics applications where long battery life is crucial. These include cell phones, mp3 players, digital cameras and PDAs. The lower ground current will increase the life of the battery and prolong the usage between charges.

### Input Capacitor

Good bypassing is recommended from input to ground to help improve AC performance. A 1 $\mu$ F capacitor or greater located close to the IC is recommended. Larger load currents may require larger capacitor values.

### Bypass Capacitor

The internal reference voltage of the MIC5312 can be bypassed with a capacitor to ground to reduce output noise and increase input ripple rejection (PSRR). A quick-start feature allows for quick turn-on of the output voltage. The recommended nominal bypass capacitor is 0.01 $\mu$ F, but an increase will result in longer turn on times  $t_{\text{on}}$ .

### Output Capacitor

Each regulator output requires a 2.2 $\mu$ F ceramic output capacitor for stability. The output capacitor value can be increased to improve transient response, but performance has been optimized for a 2.2 $\mu$ F ceramic type output capacitor. X7R/X5R dielectric-type ceramic capacitors are recommended because of their temperature performance. X7R-type capacitors change capacitance by 15% over their operating temperature range and are the most stable type of ceramic capacitors. Z5U and Y5V dielectric capacitors change value by as much as 50% to 60% respectively over their operating temperature ranges. To use a ceramic chip capacitor with Y5V dielectric, the value must be much higher than a X7R ceramic capacitor to ensure the same minimum capacitance over the equivalent operating temperature range.

### Thermal Considerations

The MIC5312 is designed to provide 300mA of continuous current per channel in a very small MLF package. Maximum power dissipation can be calculated based on the output current and the voltage drop across the part. To determine the maximum power dissipation of the package, use the junction-to-ambient thermal resistance of the device and the following basic equation:

$$P_D (\text{max}) = (T_J (\text{max}) - T_A) / \theta_{JA}$$

$T_J (\text{max})$  is the maximum junction temperature of the die, 125°C, and  $T_A$  is the ambient operating temperature.  $\theta_{JA}$  is layout dependent; Table 1 shows examples of the junction-to-ambient thermal resistance for the MIC5312.

| Package     | $\theta_{JA}$ Recommended Minimum Footprint | $\theta_{JC}$ |
|-------------|---|---------------|
| 3x3 MLF™-10 | 63°C/W                                      | 2°C/W         |

Table 1. MLF™ Thermal Resistance

The actual power dissipation of the regulator circuit can be determined using the equation:

$$P_{DTOTAL} = P_{D LDO1} + P_{D LDO2}$$

$$P_{D LDO1} = (V_{IN} - V_{OUT1}) \times I_{OUT1}$$

$$P_{D LDO2} = (V_{IN} - V_{OUT2}) \times I_{OUT2}$$

Substituting  $P_{D(max)}$  for  $P_D$  and solving for the operating conditions that are critical to the application will give the maximum operating conditions for the regulator circuit. For example, when operating the MIC5312 at 60°C with a minimum footprint layout, the maximum load currents can be calculated as follows:

$$P_D (max) = (T_J (max) - T_A) / \theta_{JA}$$

$$P_D (max) = (125^\circ\text{C} - 60^\circ\text{C}) / 63^\circ\text{C/W}$$

$$P_D (max) = 1.03\text{W}$$

The junction-to-ambient thermal resistance for the minimum footprint is **63°C/W**, from Table 1. The maximum power dissipation must not be exceeded for proper operation. Using a lithium-ion battery as the supply voltage of 4.2V, 1.8V<sub>OUT</sub>/150mA for channel 1 and 2.8V<sub>OUT</sub>/100mA for channel 2, power dissipation can be calculated as follows:

$$P_{D LDO1} = (V_{IN} - V_{OUT1}) \times I_{OUT1}$$

$$P_{D LDO1} = (4.2\text{V} - 1.8\text{V}) \times 150\text{mA}$$

$$P_{D LDO1} = 360\text{mW}$$

$$P_{D LDO2} = (V_{IN} - V_{OUT2}) \times I_{OUT2}$$

$$P_{D LDO1} = (4.2\text{V} - 2.8\text{V}) \times 100\text{mA}$$

$$P_{D LDO1} = 140\text{mW}$$

$$P_{DTOTAL} = P_{D LDO1} + P_{D LDO2}$$

$$P_{DTOTAL} = 360\text{mW} + 140\text{mW}$$

$$P_{DTOTAL} = 500\text{mW}$$

The calculation shows that we are well below the maximum allowable power dissipation of **1.03W** for a 60° ambient temperature.

After the maximum power dissipation has been calculated, it is always a good idea to calculate the maximum ambient temperature for a 125° junction temperature. Calculating maximum ambient temperature as follows:

$$T_{A(max)} = T_{J(max)} - (P_D \times \theta_{JA})$$

$$T_{A(max)} = 125^\circ\text{C} - (500\text{mW} \times 63^\circ\text{C/W})$$

$$T_{A(max)} = 93.5^\circ\text{C}$$

For a full discussion of heat sinking and thermal effects on voltage regulators, refer to the "Regulator Thermals" section of *Micrel's Designing with Low-Dropout Voltage Regulators* handbook.

This information can be found on Micrel's website at: [http://www.micrel.com/\\_PDF/other/LDOBk\\_ds.pdf](http://www.micrel.com/_PDF/other/LDOBk_ds.pdf)

**Package Information**

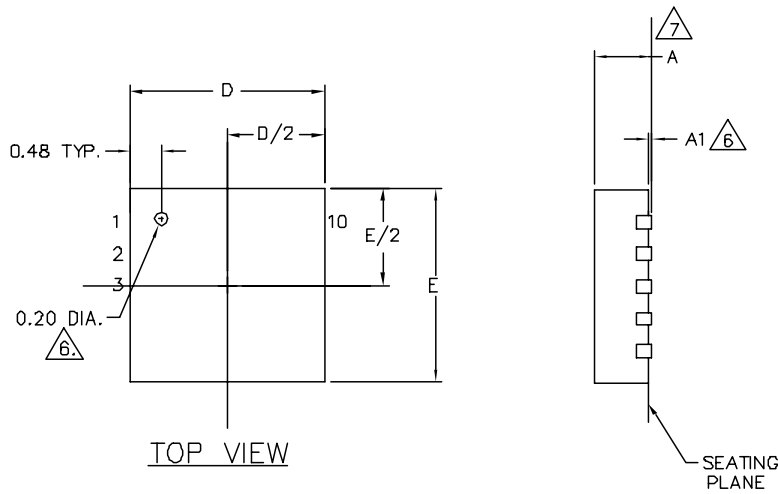

|    | DIMENSION (mm) |      |      |
|----|----------------|------|------|
|    | MIN.           | NOM. | MAX. |
| A  | 0.80           | 0.85 | 1.00 |
| A1 | 0.00           | 0.01 | 0.05 |
| D  | 3.00 BSC       |      |      |
| D2 | 1.45           | 1.60 | 1.75 |
| E  | 3.00 BSC       |      |      |
| E2 | 2.15           | 2.30 | 2.45 |
| e  | 0.50 BSC       |      |      |
| L  | 0.35           | 0.40 | 0.55 |
| b  | 0.18           | 0.23 | 0.30 |

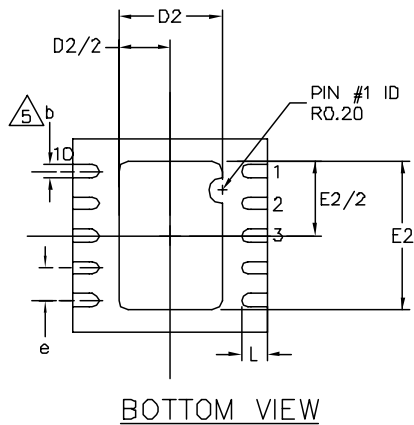

- NOTE:
1. ALL DIMENSIONS ARE IN MILLIMETERS.
  2. MAX. PACKAGE WARPAGE IS 0.05 mm.
  3. MAXIMUM ALLOWABLE BURRS IS 0.076 mm IN ALL DIRECTIONS.
  4. PIN #1 ID ON TOP WILL BE LASER/INK MARKED.
- △5 DIMENSION b APPLIES TO METALIZED TERMINAL AND IS MEASURED BETWEEN 0.20 AND 0.25 mm FROM TERMINAL TIP.
- △6 APPLIED ONLY FOR TERMINALS.
- △7 APPLIED FOR EXPOSED PAD AND TERMINALS.

**10-Pin 3x3 MLF (MLF)**

**MICREL, INC. 2180 FORTUNE DRIVE SAN JOSE, CA 95131 USA**  
 TEL +1 (408) 944-0800 FAX +1 (408) 474-1000 WEB <http://www.micrel.com>

The information furnished by Micrel in this data sheet is believed to be accurate and reliable. However, no responsibility is assumed by Micrel for its use. Micrel reserves the right to change circuitry and specifications at any time without notification to the customer.

Micrel Products are not designed or authorized for use as components in life support appliances, devices or systems where malfunction of a product can reasonably be expected to result in personal injury. Life support devices or systems are devices or systems that (a) are intended for surgical implant into the body or (b) support or sustain life, and whose failure to perform can be reasonably expected to result in a significant injury to the user. A Purchaser's use or sale of Micrel Products for use in life support appliances, devices or systems is a Purchaser's own risk and Purchaser agrees to fully indemnify Micrel for any damages resulting from such use or sale.

© 2004 Micrel, Incorporated.