



# STPS20S100C

## POWER SCHOTTKY RECTIFIER

**Table 1: Main Product Characteristics**

$I_{F(AV)}$	<b>2 x 10 A</b>
$V_{RRM}$	<b>100 V</b>
$T_j$	<b>175°C</b>
$V_F(max)$	<b>0.71 V</b>

### FEATURES AND BENEFITS

- High junction temperature capability for converters located in confined environment
- Low leakage current at high temperature
- Low static and dynamic losses as a result of the Schottky barrier
- Avalanche specification

### DESCRIPTION

Schottky barrier rectifier designed for high frequency miniature Switched Mode Power Supplies such as adaptators and on board DC/DC converters. Packaged in TO-220AB, I<sup>2</sup>PAK and TO-220FPAB.

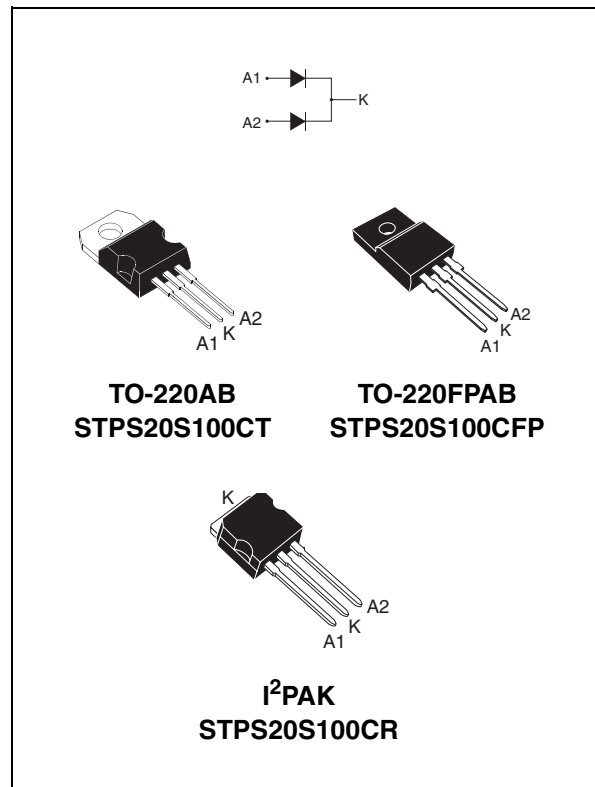

**Table 2: Order Codes**

Part Numbers	Marking
STPS20S100CT	STPS20S100CT
STPS20S100CFP	STPS20S100CFP
STPS20S100CR	STPS20S100CR

## STPS20S100C

**Table 3: Absolute Ratings** (limiting values, per diode)

Symbol	Parameter				Value	Unit
$V_{RRM}$	Repetitive peak reverse voltage				100	V
$I_{F(RMS)}$	RMS forward current				30	A
$I_{F(AV)}$	Average forward current $\delta = 0.5$	TO-220AB / I <sup>2</sup> PAK	$T_c = 150^\circ\text{C}$	Per diode	10	A
				Per device	20	
		TO-220FPAC	$T_c = 140^\circ\text{C}$	Per diode	10	A
				Per device	20	
$I_{FSM}$	Surge non repetitive forward current		$t_p = 10\text{ms}$ sinusoidal		180	A
$P_{ARM}$	Repetitive peak avalanche power		$t_p = 1\mu\text{s}$ $T_j = 25^\circ\text{C}$		7200	W
$T_{stg}$	Storage temperature range				-65 to + 175	$^\circ\text{C}$
$T_j$	Maximum operating junction temperature *				175	$^\circ\text{C}$
dV/dt	Critical rate of rise of reverse voltage				10000	V/ $\mu\text{s}$

\* :  $\frac{dP_{tot}}{dT_j} > \frac{1}{R_{th(j-a)}}$  thermal runaway condition for a diode on its own heatsink

**Table 4: Thermal Resistance**

Symbol	Parameter			Value	Unit
$R_{th(j-c)}$	Junction to case	TO-220AB / I <sup>2</sup> PAK	Per diode	2.2	$^\circ\text{C/W}$
			Total	1.3	
$R_{th(c)}$			Coupling	0.3	
$R_{th(j-c)}$	Junction to case	TO-220FPAB	Per diode	4.5	$^\circ\text{C/W}$
			Total	3.5	
$R_{th(c)}$			Coupling	2.5	

When the diodes 1 and 2 are used simultaneously:

$$\Delta T_j(\text{diode 1}) = P(\text{diode 1}) \times R_{th(j-c)}(\text{Per diode}) + P(\text{diode 2}) \times R_{th(c)}$$

**Table 5: Static Electrical Characteristics** (per diode)

Symbol	Parameter	Tests conditions		Min.	Typ	Max.	Unit
$I_R$ *	Reverse leakage current	$T_j = 25^\circ\text{C}$	$V_R = V_{RRM}$			3.5	$\mu\text{A}$
		$T_j = 125^\circ\text{C}$			1.3	4.5	mA
$V_F$ **	Forward voltage drop	$T_j = 25^\circ\text{C}$	$I_F = 5\text{A}$			0.73	V
		$T_j = 125^\circ\text{C}$			0.57	0.61	
		$T_j = 25^\circ\text{C}$	$I_F = 10\text{A}$			0.85	
		$T_j = 125^\circ\text{C}$			0.66	0.71	
		$T_j = 25^\circ\text{C}$	$I_F = 20\text{A}$			0.94	
		$T_j = 125^\circ\text{C}$			0.74	0.80	

Pulse test: \*  $t_p = 5\text{ms}$ ,  $\delta < 2\%$

\*\*  $t_p = 380\mu\text{s}$ ,  $\delta < 2\%$

To evaluate the conduction losses use the following equation:  $P = 0.62 \times I_{F(AV)} + 0.009 I_{F(RMS)}^2$

Figure 1: Average forward power dissipation versus average forward current (per diode)

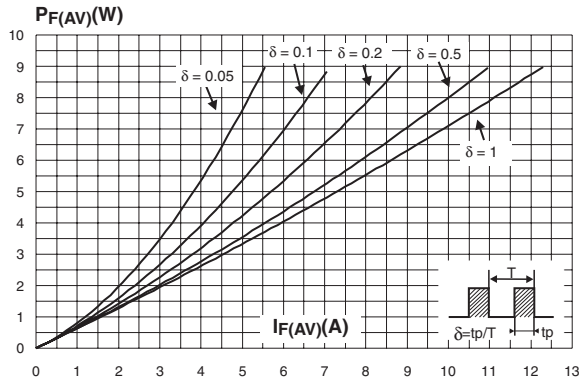

Figure 2: Average forward current versus ambient temperature ( $\delta = 0.5$ , per diode)

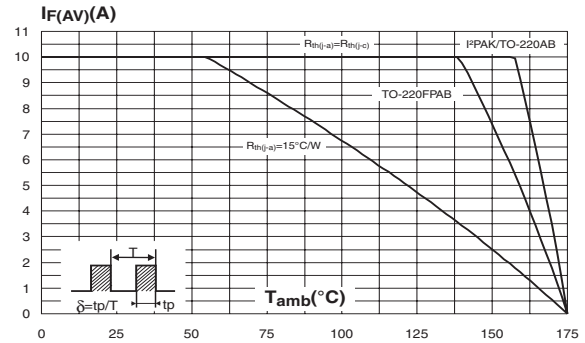

Figure 3: Normalized avalanche power derating versus pulse duration

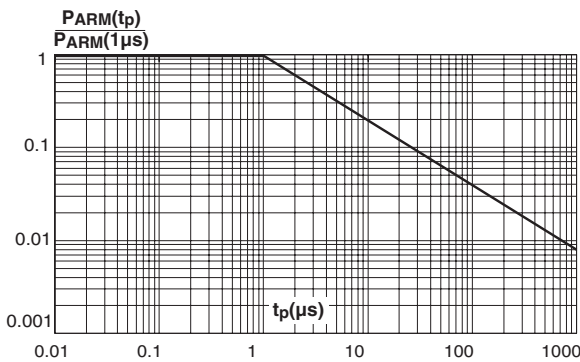

Figure 4: Normalized avalanche power derating versus junction temperature

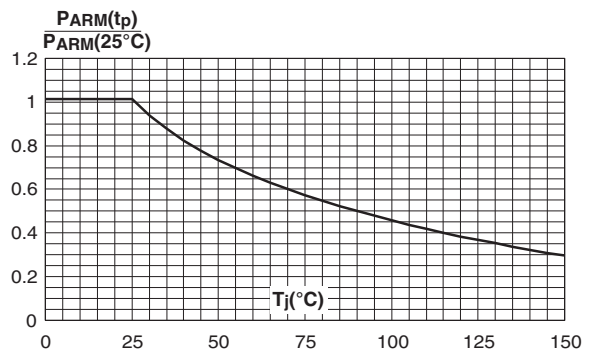

Figure 5: Non repetitive surge peak forward current versus overload duration (maximum values, per diode)

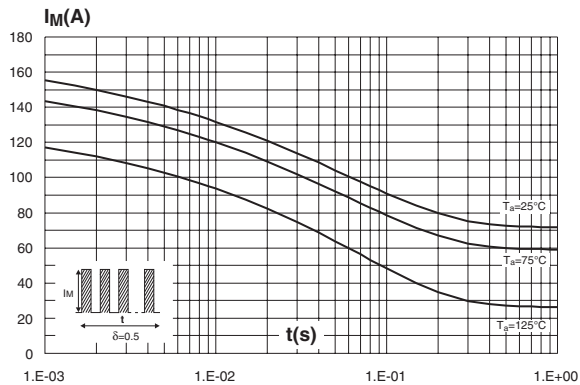
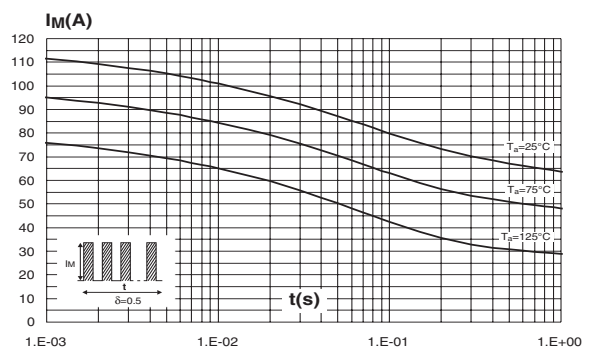
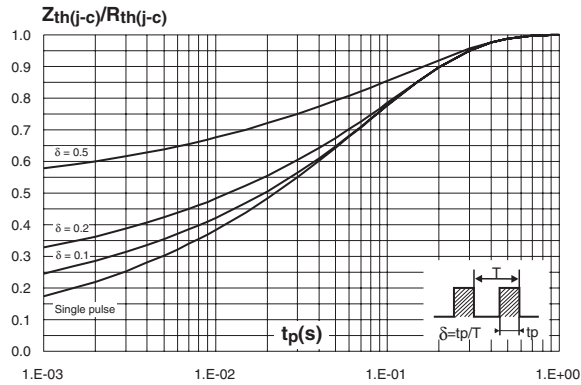

Figure 6: Non repetitive surge peak forward current versus overload duration (maximum values, per diode) (TO-220FPAB)



**Figure 7: Relative variation of thermal impedance junction to case versus pulse duration (per diode)**



**Figure 7: Reverse leakage current versus reverse voltage applied (typical values, per diode)**

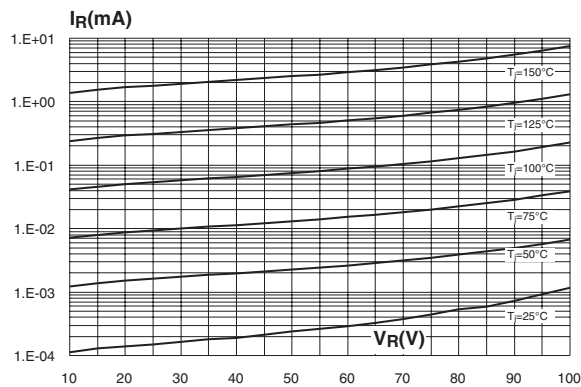

**Figure 9: Forward voltage drop versus forward current (per diode)**

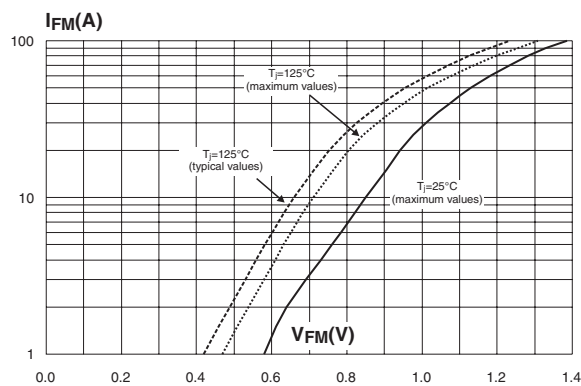

**Figure 8: Relative variation of thermal impedance junction to case versus pulse duration (per diode) (TO-220FPAB)**

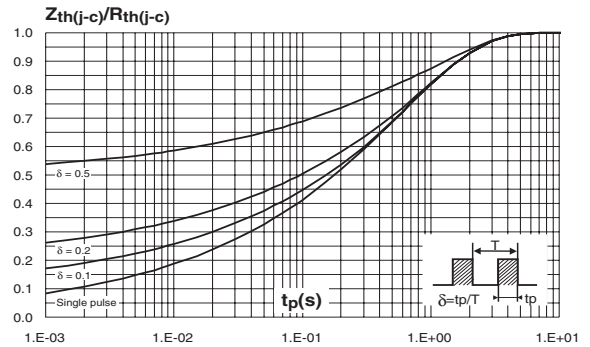

**Figure 8: Junction capacitance versus reverse voltage applied (typical values, per diode)**

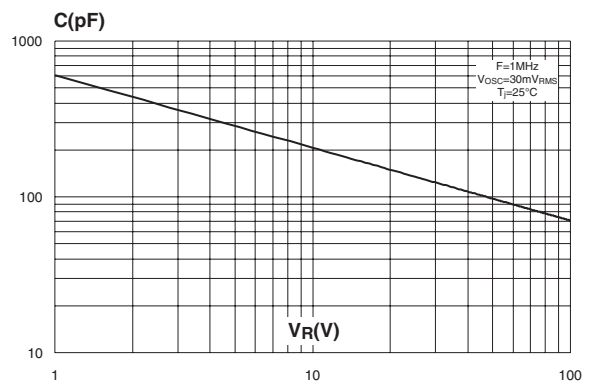

Figure 10: TO-220FPAB Package Mechanical Data

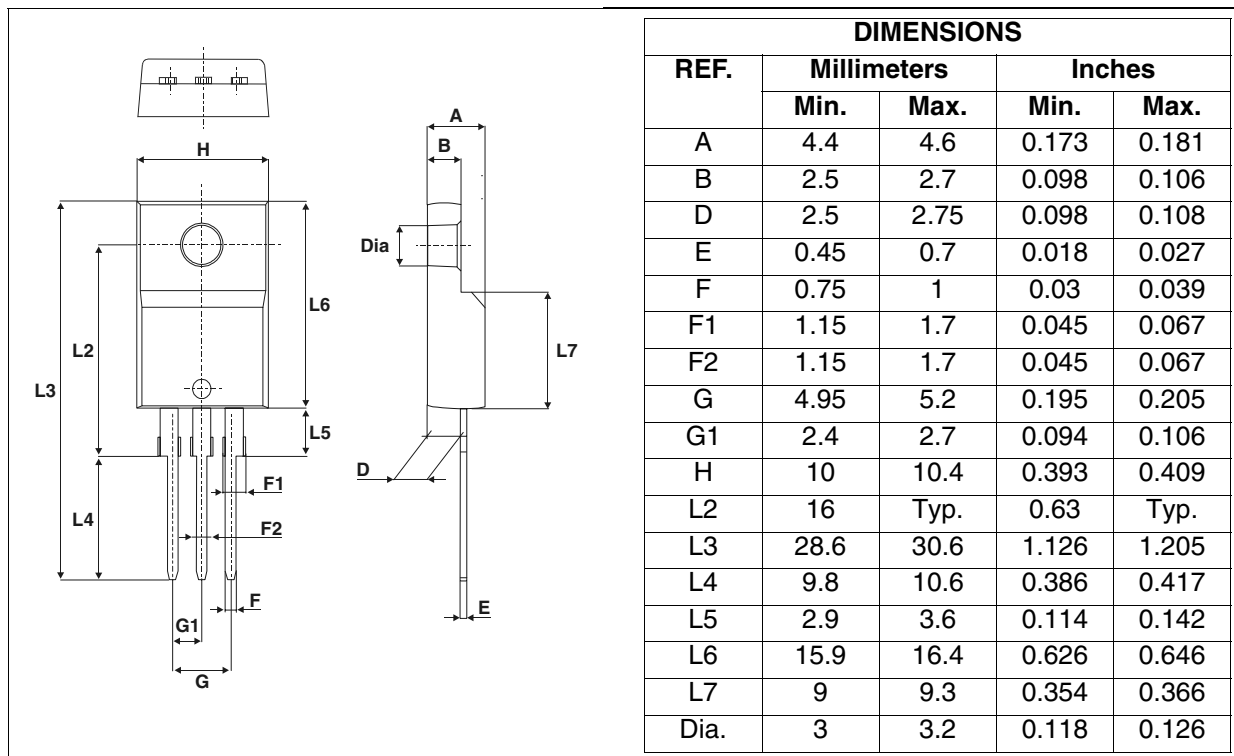
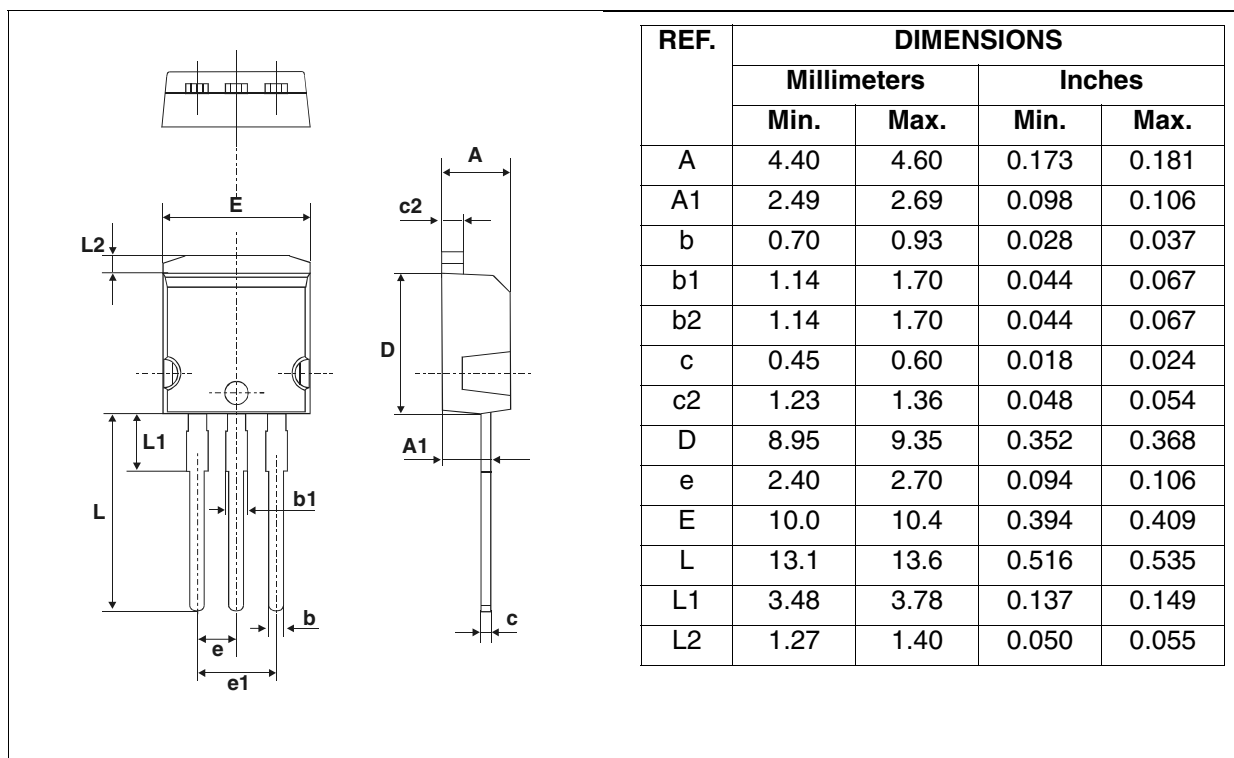

Figure 11: I<sup>2</sup>PAK Package Mechanical Data



# STPS20S100C

Figure 12: TO-220AB Package Mechanical Data

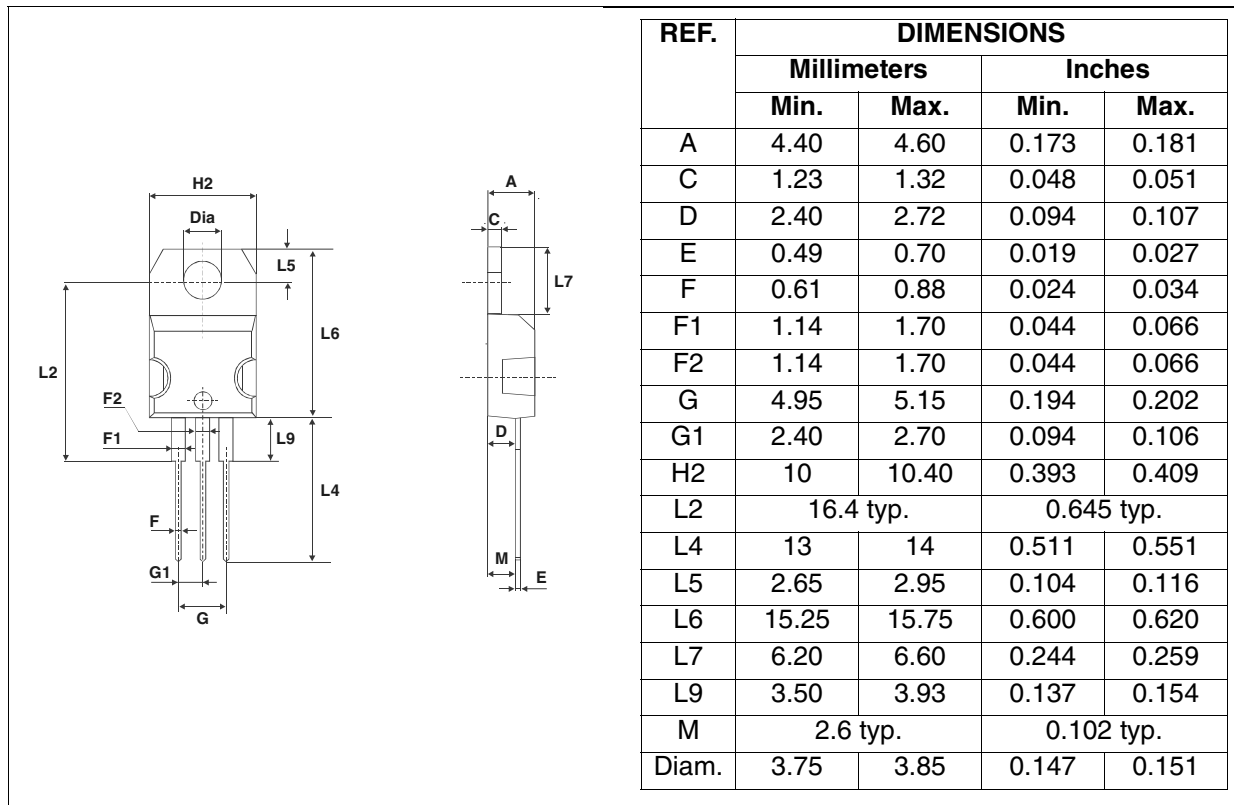

Table 6: Ordering Information

Ordering type	Marking	Package	Weight	Base qty	Delivery mode
STPS20S100CT	STPS20S100CT	TO-220AB	2.20 g	50	Tube
STPS20S100CFP	STPS20S100CFP	TO-220FPAB	2 g	50	Tube
STPS20S100CR	STPS20S100CR	I <sup>2</sup> PAK	1.49 g	50	Tube

- Epoxy meets UL94, V0
- Cooling method: by conduction (C)
- Recommended torque value: 0.8 m.N.
- Maximum torque value: 1.0 m.N.

Table 7: Revision History

Date	Revision	Description of Changes
16-Mar-2005	1	First issue.

Information furnished is believed to be accurate and reliable. However, STMicroelectronics assumes no responsibility for the consequences of use of such information nor for any infringement of patents or other rights of third parties which may result from its use. No license is granted by implication or otherwise under any patent or patent rights of STMicroelectronics. Specifications mentioned in this publication are subject to change without notice. This publication supersedes and replaces all information previously supplied. STMicroelectronics products are not authorized for use as critical components in life support devices or systems without express written approval of STMicroelectronics.

The ST logo is a registered trademark of STMicroelectronics.  
All other names are the property of their respective owners

© 2005 STMicroelectronics - All rights reserved

**STMicroelectronics group of companies**

Australia - Belgium - Brazil - Canada - China - Czech Republic - Finland - France - Germany - Hong Kong - India - Israel - Italy - Japan - Malaysia - Malta - Morocco - Singapore - Spain - Sweden - Switzerland - United Kingdom - United States of America

**[www.st.com](http://www.st.com)**