

TOSHIBA Photo IC Silicon Epitaxial Planar

TPS819

Mobile Phones, PHS, Pagers
 Notebook PCs, PDAs
 Cameras
 Other Equipment Requiring Luminosity Adjustment

The TPS819 is a linear-output photo-IC which incorporates a photodiode and a current amp circuit in a single chip. This photo-IC also incorporates a luminous-efficiency correction filter, so output value is close to luminosity characteristics.

- High sensitivity : $I_L = 50\sim 100 \mu A$
 @EV = 100 lx $\lambda_p = 522 \text{ nm LED}$
- Luminous efficiency correction filter mounted on detector
 : $\lambda_p = 550 \text{ nm (typ.)}$
- Open-emitter output
- Compact and light surface-mount package

Maximum Ratings (Ta = 25°C)

Characteristics	Symbol	Rating	Unit
Supply voltage	V _{CC}	-0.5~7	V
Output voltage	V _{OUT}	≤ V _{CC}	V
Light current	I _L	10	mA
Permissible power dissipation	P	70	mW
Operating temperature range	T _{opr}	-25~85	°C
Storage temperature range	T _{stg}	-40~100	°C
Soldering temperature range (Note 1)	T _{sol}	260	°C

Note 1: The reflow time and the recommended temperature profile are shown in the section entitled Handling Precautions.

Unit: mm

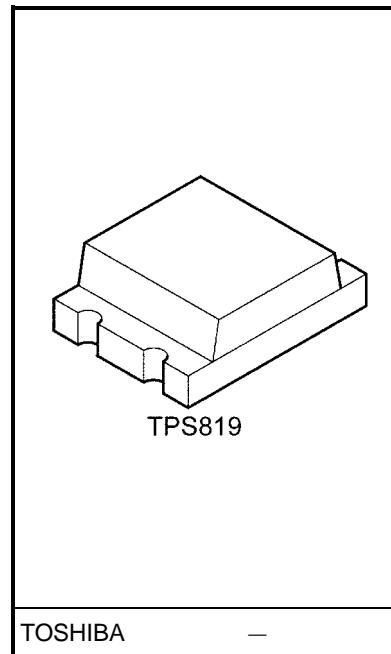

Weight: 0.017 g (typ.)

Recommended Operating Conditions

Characteristics	Symbol	Min	Typ.	Max	Unit
Supply voltage	V_{CC}	2.2	—	5.5	V
Lead resistance	R_L	510	—	—	Ω

Electrical and Optical Characteristics (Ta = 25°C)

Characteristics	Symbol	Test Condition	Min	Typ.	Max	Unit
Supply current	I_{CC}	$V_{CC} = 3\text{ V}$, $E_V = 1000\text{ lx}$, $R_L = 1\text{ k}\Omega$ (Note 2)	—	2	—	mA
Light current (1)	$I_L(1)$	$V_{CC} = 3\text{ V}$, $E_V = 10\text{ lx}$ (Note 2, 5)	—	20	—	μA
Light current (2)	$I_L(2)$	$V_{CC} = 3\text{ V}$, $E_V = 100\text{ lx}$ (Note 2, 5)	—	200	—	
Light current (3)	$I_L(3)$	$V_{CC} = 3\text{ V}$, $\lambda_p = 522\text{ nm}$, $E_V = 100\text{ lx}$ (Note 3, 5)	50	—	100	
Light current ratio	$\frac{I_L(\text{IR})}{I_L(3)}$ (Note 4, 5)		—	0.03	0.10	
Dark current	I_{LEAK}	$V_{CC} = 3.3\text{ V}$, $E_V = 0$	—	—	0.5	μA
Saturation output voltage	V_o	$V_{CC} = 3\text{ V}$, $R_L = 75\text{ k}\Omega$, $E_V = 100\text{ lx}$ (Note 3)	2.2	2.35	—	V
Peak sensitivity wavelength	λ_p	—	—	550	—	nm
Switching time	t_r	$V_{CC} = 3\text{ V}$, $R_L = 5\text{ k}\Omega$, $\lambda_p = 522\text{ nm}$ (Note 6)	—	0.2	—	ms
	t_f		—	1	—	
	t_d		—	0.3	—	
	t_s		—	0.02	—	

Note 2: CIE standard A light source is used (color temperature = 2856K)

Note 3: Green LED ($\lambda_p = 522\text{ nm}$) is used as light source and set an illuminance meter for 100 lx.
Light current classification: A Rank: 50~83.5 μA , B Rank: 60~100 μA

Note 4: Infrared LED ($\lambda_p = 870\text{ nm}$) is used as light source for $I_L(\text{IR})$ and light current is set to obtain $V_{CC} = 3\text{ V}$ and $E = 0.01\text{ mW/cm}^2$.

Note 5: Light current measurement circuit

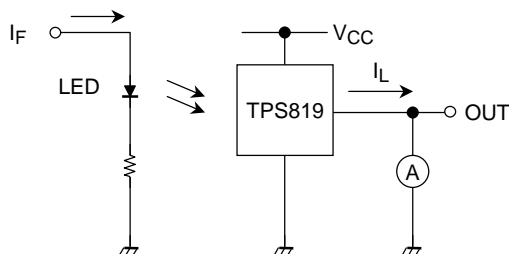

Note 6: Rise time/fall time measurement method

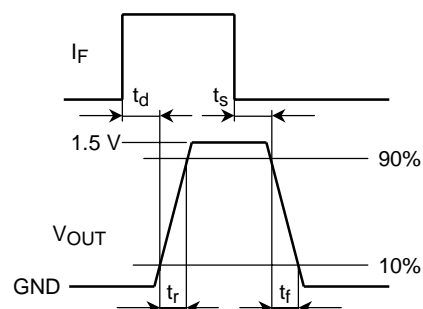
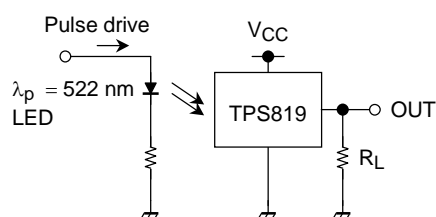

Package Dimensions

TPS819

Unit: mm

Tolerance: ± 0.2

 : Sensitive area

Sensitive area: $\square 0.35$

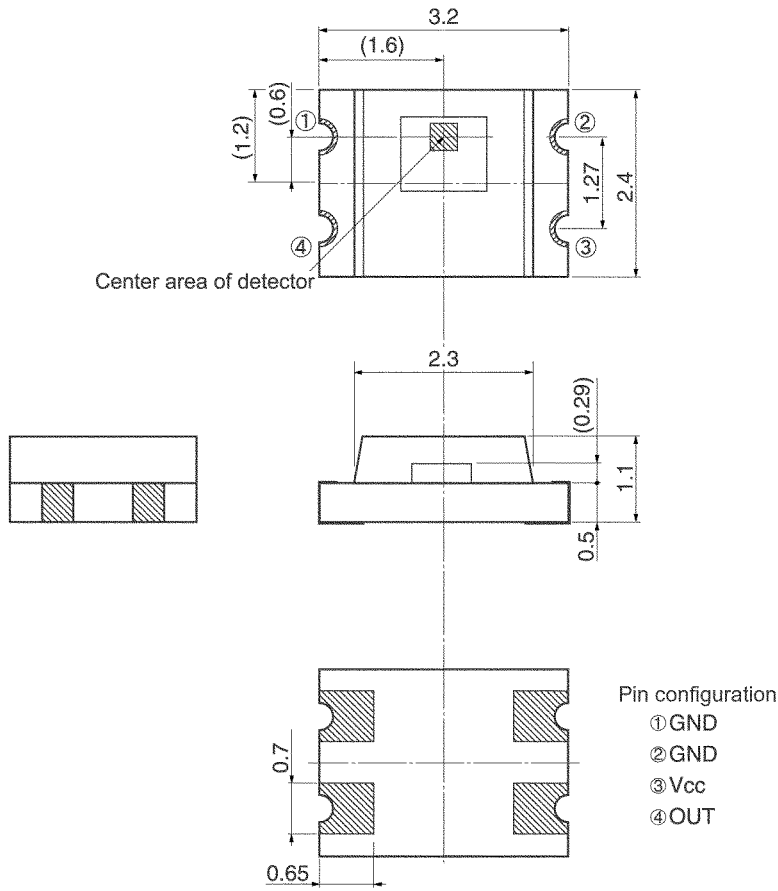

Weight: 0.017 g (typ.)

Pin Connection

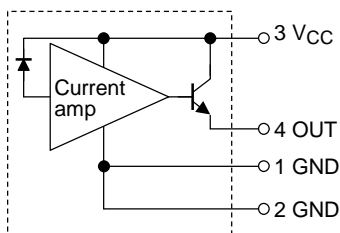

Handling Precautions

- At power-on in darkness the internal circuit takes about 50 ms to stabilize. During this period the output signal is unstable and may change. Please take this into account.

Moisture-proof Packing

- To avoid moisture absorption by the resin, the product is packed in an aluminum envelope with silica gel.
- The optical characteristics of the devices may be affected by exposure to moisture in the air before soldering and they should therefore be stored after opening the moisture proof bag under the following conditions:
Temperature: 5°C~30°C, Humidity: 60% (max), Storage time: 168 h (max)
- Please perform baking when the storage time is expired. Expiration date for an unopened moisture proof bag is six month and 168 h for an opened moisture proof bag. This device is a tape packed product; hence, do not bake the product at high temperature:
Recommended baking condition: Baking Temperature = 60°C, Baking Hours = 12 h or longer

Mounting Precautions

- Do not apply stress to the resin at high temperature.
- The resin part is easily scratched, so avoid friction with hard materials.
- When installing the assembly board in equipment, ensure that this product does not come into contact with other components.

Mounting Methods

- Reflow soldering
 - Package surface temperature: 260°C (max)
 - Please perform reflow soldering using the following reference temperature profile. Perform reflow soldering no more than twice.

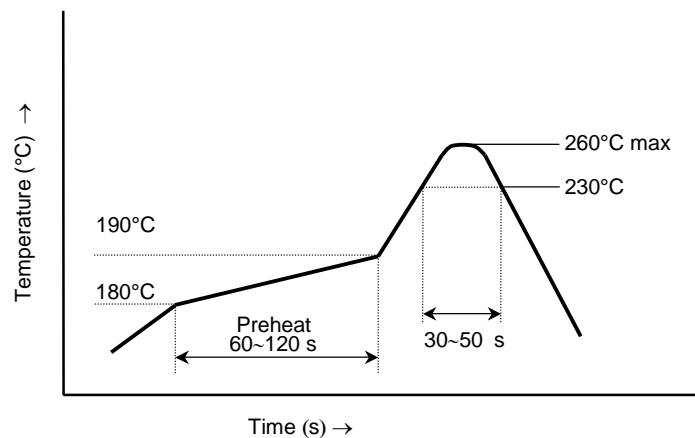

- Please perform the first reflow soldering with reference to the above temperature profile and within 168 h of opening the package.
- Second reflow soldering
In case of second reflow soldering should be performed within 168 h of the first reflow under the above conditions.
Storage conditions before the second reflow soldering: 30°C, 60% RH max
- Do not perform flow soldering.
- Make any necessary soldering corrections manually.
(only once at each soldering point)
Temperature: 350°C or less
Time: within 5 s

(2) Recommended soldering pattern

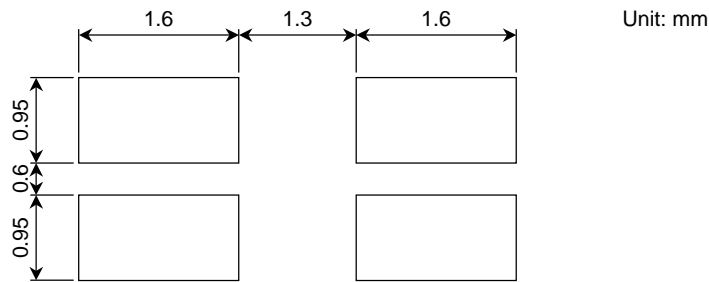

(3) Cleaning conditions

When cleaning is required after soldering

Chemicals: AK225 alcohol

Temperature and time: 50°C × 30 s or : 30°C × 3 min

Ultrasonic cleaning: 300 W or less

Packing Display

(1) Packing quantity

Reel (minimum packing quantity)	3000 pcs
Carton	5 reels (15000 pcs)

(2) Packing form

To avoid moisture absorption by the resin, the devices are sealed in an aluminum package with silica gel. Buffer materials are enclosed with carton.

- Carton appearance

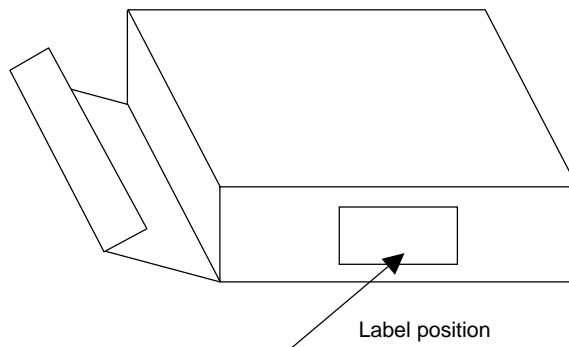

Carton dimensions

(W) 81 mm × (L) 280 mm (H) 280 mm

Tape Packing Specifications

(1) Reel dimensions

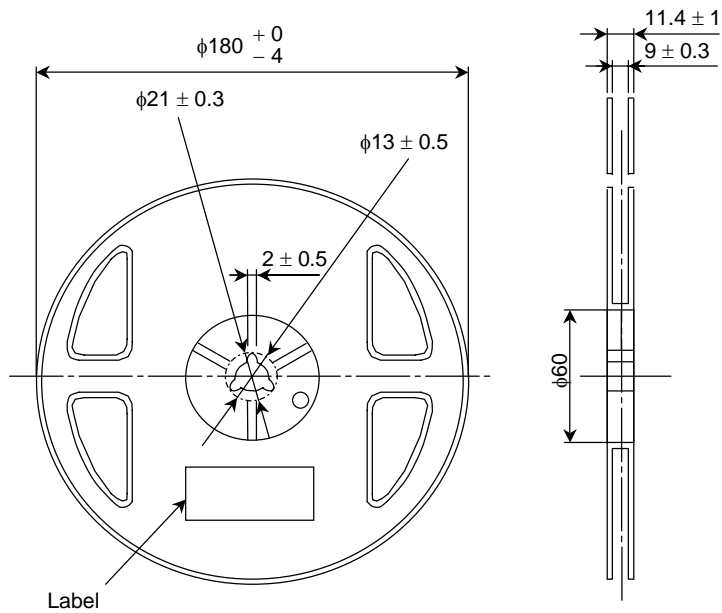

(2) Tape dimensions

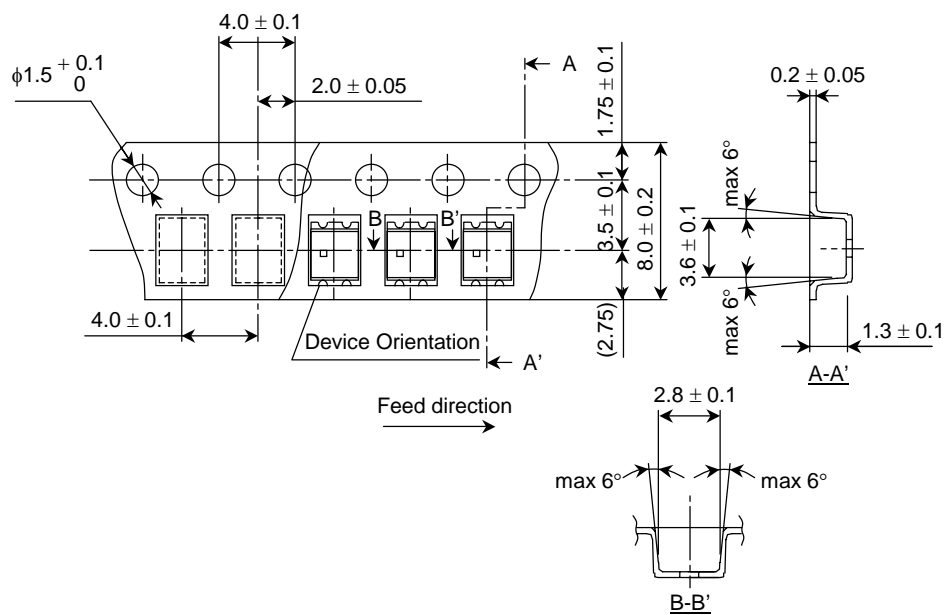

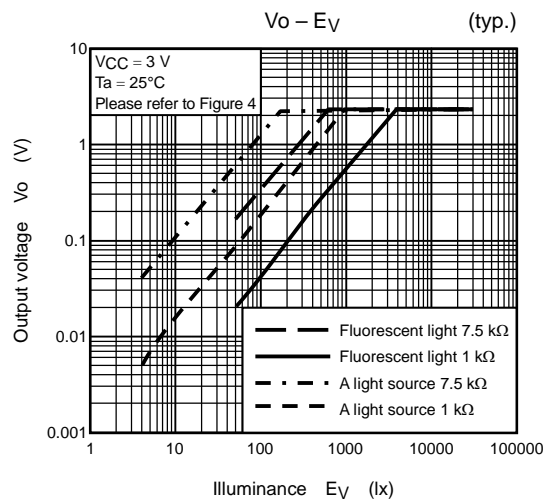
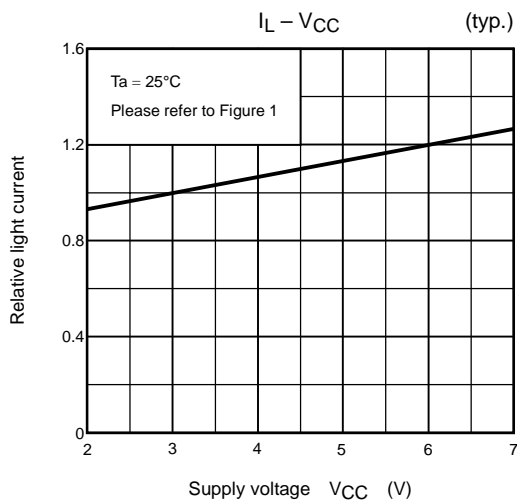
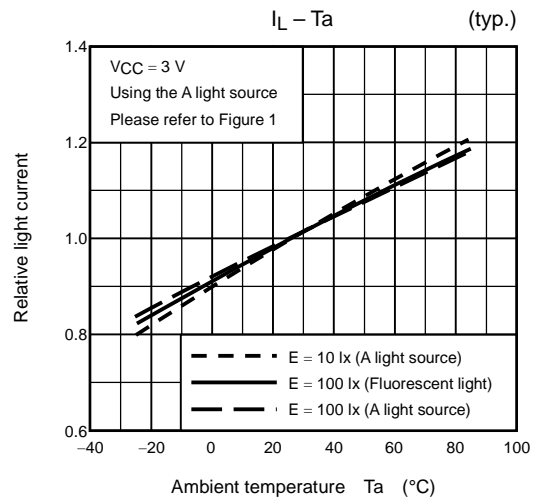
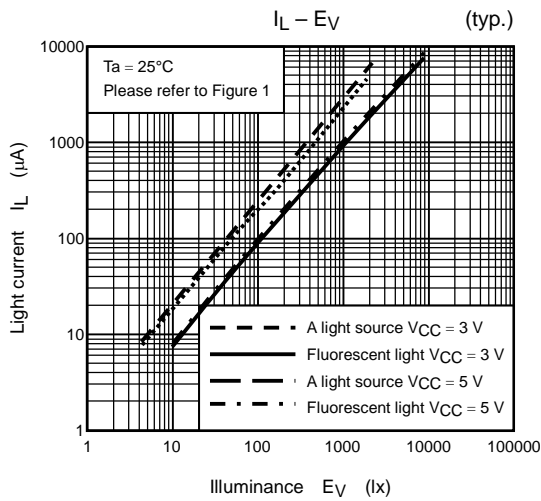
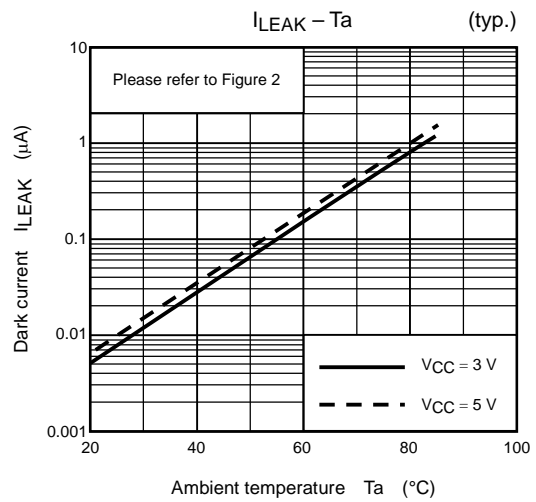
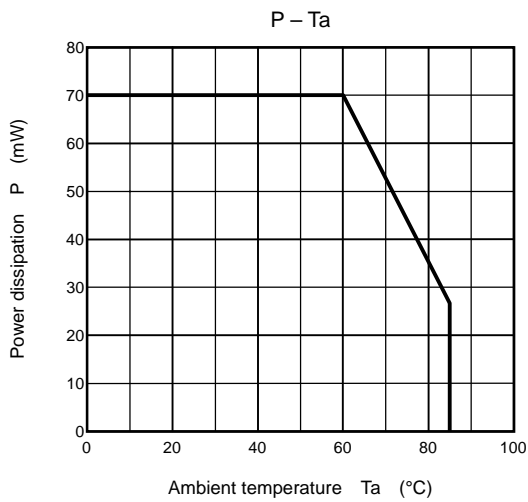

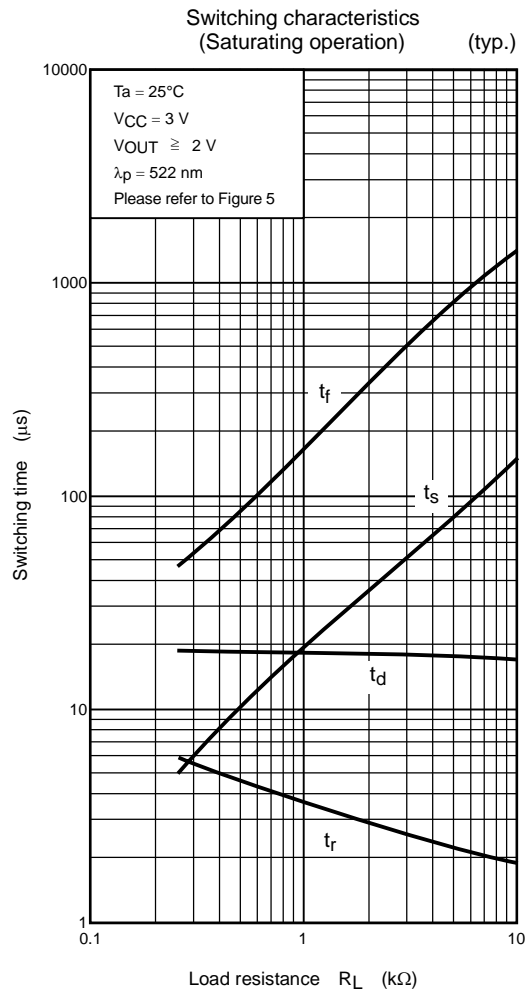
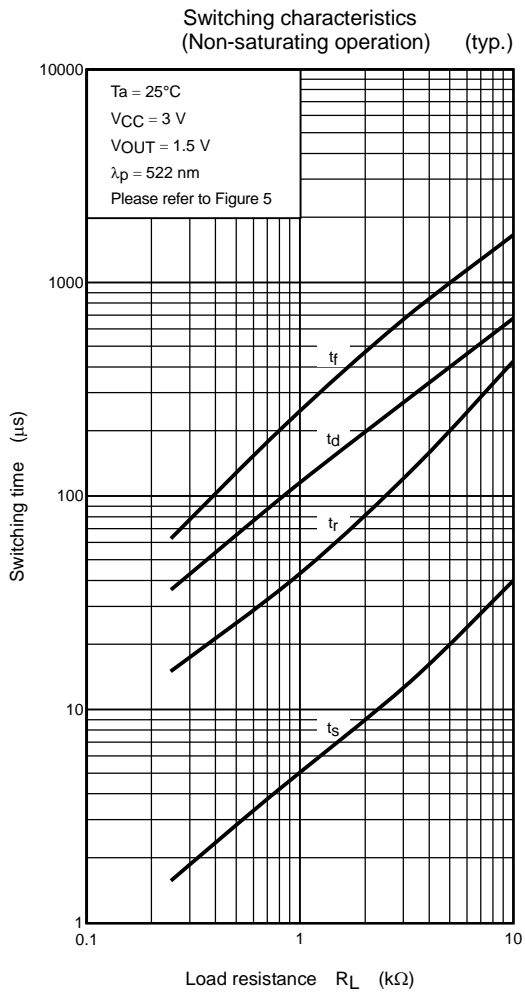
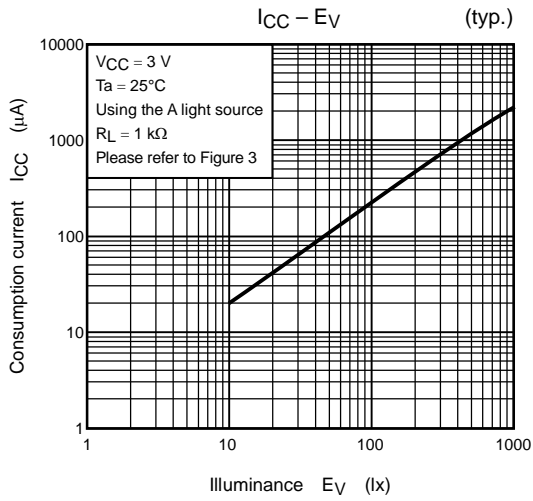

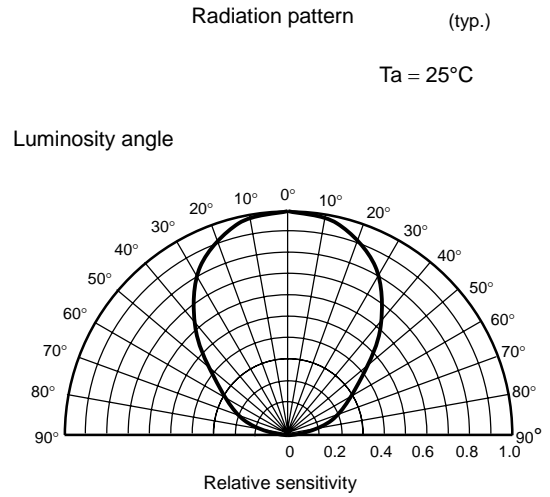
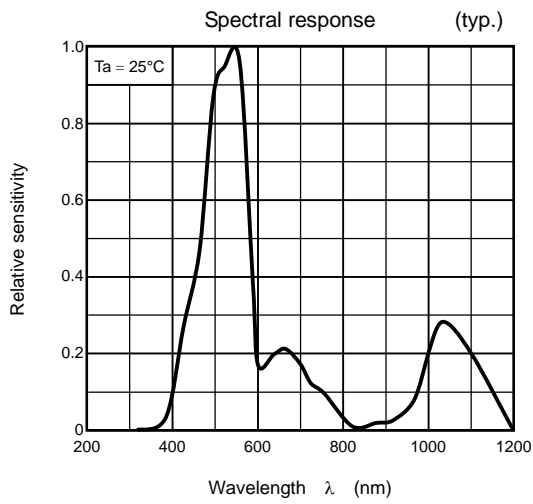

Measurement Circuits

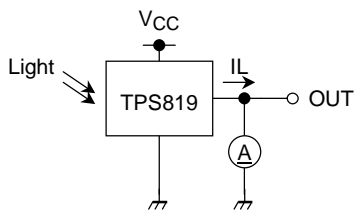

Figure 1 Light current measurement circuit

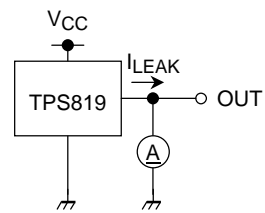

Figure 2 Dark current measurement circuit

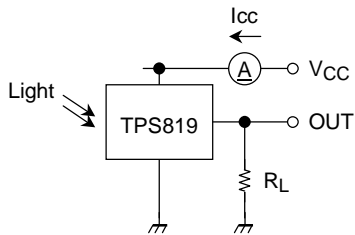

Figure 3 Consumption current measurement circuit

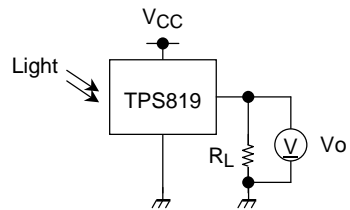

Figure 4 Output voltage measurement circuit

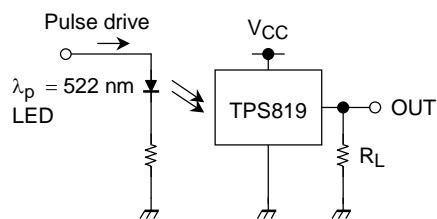

Figure 5 Switching measurement circuit

RESTRICTIONS ON PRODUCT USE

000707EBA

- TOSHIBA is continually working to improve the quality and reliability of its products. Nevertheless, semiconductor devices in general can malfunction or fail due to their inherent electrical sensitivity and vulnerability to physical stress. It is the responsibility of the buyer, when utilizing TOSHIBA products, to comply with the standards of safety in making a safe design for the entire system, and to avoid situations in which a malfunction or failure of such TOSHIBA products could cause loss of human life, bodily injury or damage to property.
In developing your designs, please ensure that TOSHIBA products are used within specified operating ranges as set forth in the most recent TOSHIBA products specifications. Also, please keep in mind the precautions and conditions set forth in the "Handling Guide for Semiconductor Devices," or "TOSHIBA Semiconductor Reliability Handbook" etc..
- The TOSHIBA products listed in this document are intended for usage in general electronics applications (computer, personal equipment, office equipment, measuring equipment, industrial robotics, domestic appliances, etc.). These TOSHIBA products are neither intended nor warranted for usage in equipment that requires extraordinarily high quality and/or reliability or a malfunction or failure of which may cause loss of human life or bodily injury ("Unintended Usage"). Unintended Usage include atomic energy control instruments, airplane or spaceship instruments, transportation instruments, traffic signal instruments, combustion control instruments, medical instruments, all types of safety devices, etc.. Unintended Usage of TOSHIBA products listed in this document shall be made at the customer's own risk.
- The products described in this document are subject to the foreign exchange and foreign trade laws.
- The information contained herein is presented only as a guide for the applications of our products. No responsibility is assumed by TOSHIBA CORPORATION for any infringements of intellectual property or other rights of the third parties which may result from its use. No license is granted by implication or otherwise under any intellectual property or other rights of TOSHIBA CORPORATION or others.
- The information contained herein is subject to change without notice.