

**MOTOROLA SEMICONDUCTOR TECHNICAL DATA**

PNP  
**2N5986, 2N5987**  
**2N5988**  
 NPN  
**2N5989, 2N5991**

**HIGH POWER PLASTIC COMPLEMENTARY SILICON POWER TRANSISTORS**

... designed for use in general-purpose amplifier and switching circuits.

- Collector-Base Voltage –  $V_{CB0}$  = 60 Vdc – 2N5986, 2N5989  
 = 80 Vdc – 2N5987  
 = 100 Vdc – 2N5988, 2N5991
- Collector-Emitter Voltage –  $V_{CEO}$  = 40 Vdc – 2N5986, 2N5989  
 = 60 Vdc – 2N5987  
 = 80 Vdc – 2N5988, 2N5991
- DC Current Gain –  
 $h_{FE} = 20-120 @ I_C = 6.0 \text{ Adc}$   
 $= 7.0 (\text{Min}) @ I_C = 12 \text{ Adc}$
- Collector-Emitter Saturation Voltage –  
 $V_{CE(\text{sat})} = 0.7 \text{ Vdc (Max) } @ I_C = 6.0 \text{ Adc}$

**12 AMPERE POWER TRANSISTORS COMPLEMENTARY SILICON**

**40, 60, 80 VOLTS**  
**100 WATTS**

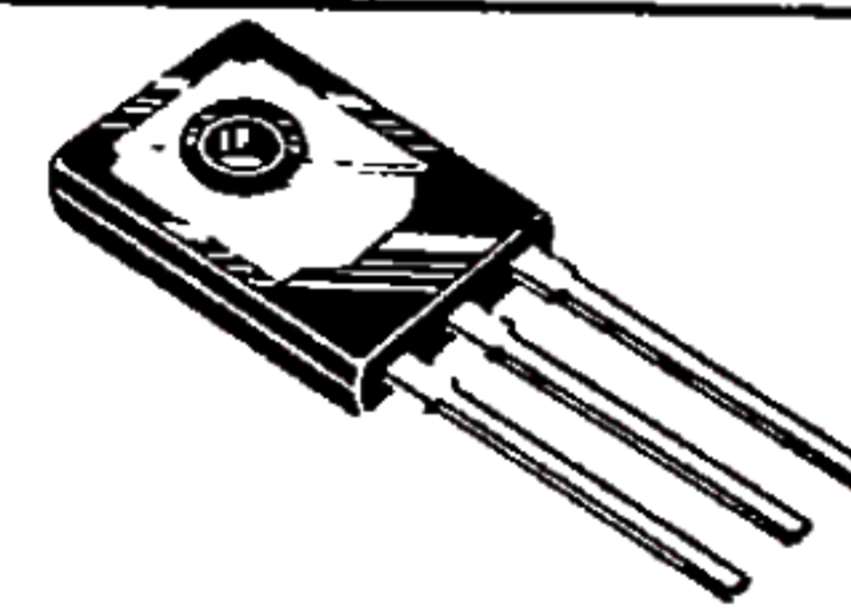

**\*MAXIMUM RATINGS**

Rating	Symbol	2N5986 2N5989	2N5987	2N5988 2N5991	Unit
Collector-Base Voltage	$V_{CB}$	60	80	100	Vdc
Collector-Emitter Voltage	$V_{CEO}$	40	60	80	Vdc
Emitter-Base Voltage	$V_{EB}$	5.0			Vdc
Collector Current – Continuous Peak	$I_C$	12			Adc
		20			
Base Current	$I_B$	4.0			Adc
Total Power Dissipation @ $T_C = 25^\circ\text{C}$ Derate above $25^\circ\text{C}$	$P_D$	100			Watts
		0.8			W/ $^\circ\text{C}$
Operating and Storage Junction Temperature Range	$T_J, T_{stg}$	-65 to +150			$^\circ\text{C}$

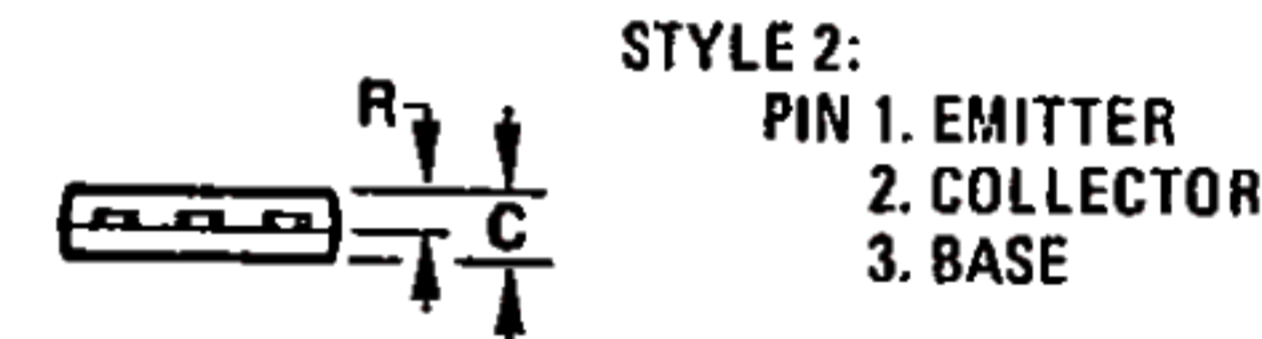
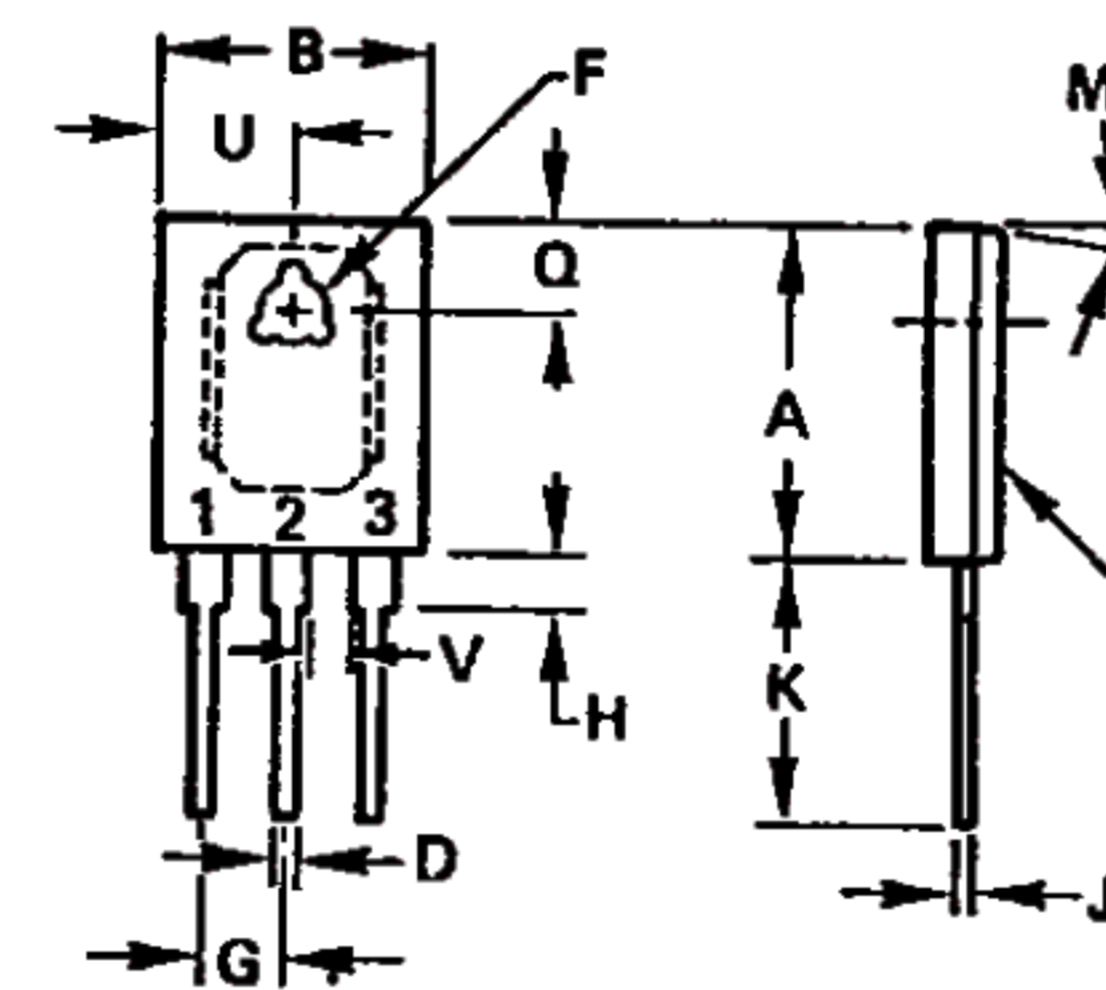

STYLE 2:  
 PIN 1. EMITTER  
 2. COLLECTOR  
 3. BASE

**NOTES:**

1. DIM "D" UNCONTROLLED IN ZONE "H"
2. DIM "F" DIA THRU
3. HEAT SINK CONTACT AREA (BOTTOM)
4. LEADS WITHIN 0.005" RAD OF TRUE POSITION (TP) AT MAXIMUM MATERIAL CONDITION.

DIM	MILLIMETERS		INCHES	
	MIN	MAX	MIN	MAX
A	16.13	16.38	0.635	0.645
B	12.57	12.83	0.495	0.505
C	3.18	3.43	0.125	0.135
D	1.09	1.24	0.043	0.049
F	3.51	3.76	0.138	0.148
G	4.22 BSC		0.166 BSC	
H	2.67	2.92	0.105	0.115
J	0.813	0.864	0.032	0.034
K	15.11	16.38	0.595	0.645
M	90 TYP		90 TYP	
Q	4.70	4.95	0.185	0.195
R	1.91	2.16	0.075	0.085
U	6.22	6.48	0.245	0.255
V	2.03	—	0.080	—

CASE 90-05  
 TO-225AB

**THERMAL CHARACTERISTICS**

Characteristic	Symbol	Max	Unit
Thermal Resistance, Junction to Case	$\theta_{JC}$	1.25	$^\circ\text{C/W}$

\* Indicates JEDEC Registered Data

**FIGURE 1 – POWER DERATING**

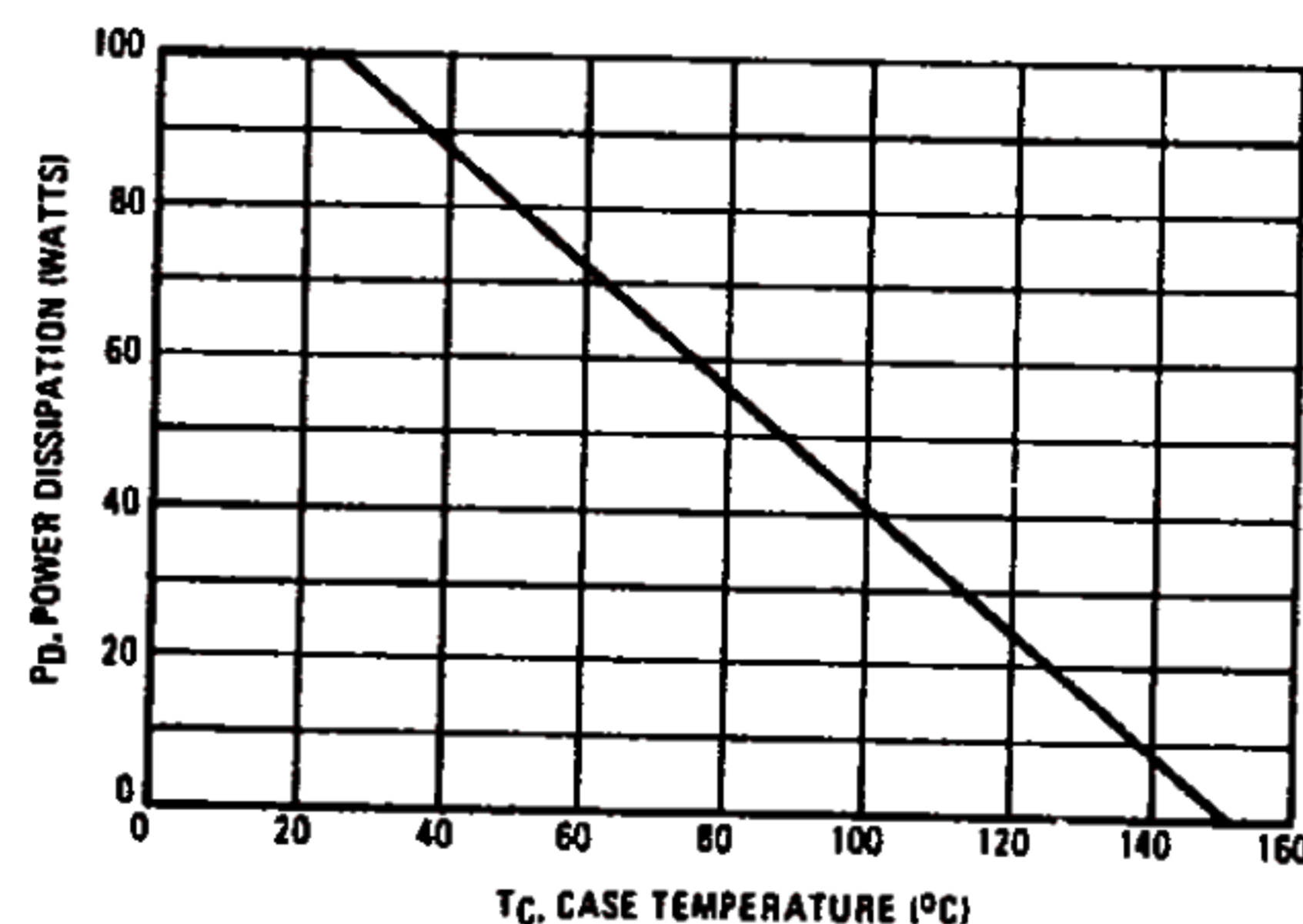

6367254 MOTOROLA SC (XSTRS/R F)

2N5986, 2N5987, 2N5988 PNP / 2N5989, 2N5991 NPN

\*ELECTRICAL CHARACTERISTICS (T<sub>C</sub> = 25°C unless otherwise noted)

Characteristic	Symbol	Min	Max	Unit
<b>OFF CHARACTERISTICS</b>				
Collector-Emitter Sustaining Voltage (I <sub>C</sub> = 0.2 Adc, I <sub>B</sub> = 0)	V <sub>CEO(sus)</sub>	40 60 80	—	Vdc
Collector Cutoff Current (V <sub>CE</sub> = 20 Vdc, I <sub>B</sub> = 0) (V <sub>CE</sub> = 30 Vdc, I <sub>B</sub> = 0) (V <sub>CE</sub> = 40 Vdc, I <sub>B</sub> = 0)	I <sub>CEO</sub>	—	2.0 2.0 2.0	mAdc
Collector Cutoff Current (V <sub>CE</sub> = 60 Vdc, V <sub>BE(off)</sub> = 1.5 Vdc) (V <sub>CE</sub> = 80 Vdc, V <sub>BE(off)</sub> = 1.5 Vdc) (V <sub>CE</sub> = 100 Vdc, V <sub>BE(off)</sub> = 1.5 Vdc)	I <sub>CEX</sub>	—	200 200 200	μAdc
Collector Cutoff Current (V <sub>CE</sub> = 40 Vdc, V <sub>BE(off)</sub> = 1.5 Vdc, T <sub>C</sub> = 125°C) (V <sub>CE</sub> = 60 Vdc, V <sub>BE(off)</sub> = 1.5 Vdc, T <sub>C</sub> = 125°C) (V <sub>CE</sub> = 80 Vdc, V <sub>BE(off)</sub> = 1.5 Vdc, T <sub>C</sub> = 125°C)	I <sub>CEX</sub>	—	2.0 2.0 2.0	mAdc
Emitter Cutoff Current (V <sub>BE</sub> = 5.0 Vdc, I <sub>C</sub> = 0)	I <sub>EBO</sub>	—	1.0	mAdc
<b>ON CHARACTERISTICS</b>				
DC Current Gain (I <sub>C</sub> = 1.5 Adc, V <sub>CE</sub> = 2.0 Vdc) (I <sub>C</sub> = 6.0 Adc, V <sub>CE</sub> = 2.0 Vdc) (I <sub>C</sub> = 12 Adc, V <sub>CE</sub> = 2.0 Vdc)	h <sub>FE</sub>	40 20 7.0	— 120 —	—
Collector-Emitter Saturation Voltage (I <sub>C</sub> = 6.0 Adc, I <sub>B</sub> = 0.6 Adc) (I <sub>C</sub> = 12 Adc, I <sub>B</sub> = 1.8 Adc)	V <sub>CE(sat)</sub>	—	0.6 1.7	Vdc
Base-Emitter Saturation Voltage (I <sub>C</sub> = 12 Adc, I <sub>B</sub> = 1.8 Adc)	V <sub>BE(sat)</sub>	—	2.5	Vdc
Base-Emitter On Voltage (I <sub>C</sub> = 6.0 Adc, V <sub>CE</sub> = 2.0 Vdc)	V <sub>BE(on)</sub>	—	1.4	Vdc
<b>DYNAMIC CHARACTERISTICS</b>				
Current-Gain – Bandwidth Product (I <sub>C</sub> = 0.5 Adc, V <sub>CE</sub> = 10 Vdc, f <sub>test</sub> = 1.0 MHz)	f <sub>T</sub>	2.0	—	MHz
Output Capacitance (V <sub>CB</sub> = 10 Vdc, I <sub>E</sub> = 0, f = 1.0 MHz)	C <sub>ob</sub>	—	500 300	pF
Small-Signal Current Gain (I <sub>C</sub> = 2.0 Adc, V <sub>CE</sub> = 4.0 Vdc, f = 1.0 kHz)	h <sub>fe</sub>	20	—	—

\*Indicates JEDEC Registered Data.

(1) f<sub>T</sub> = |h<sub>fe</sub>| • f<sub>test</sub>

FIGURE 2 – SWITCHING TIMES TEST CIRCUIT

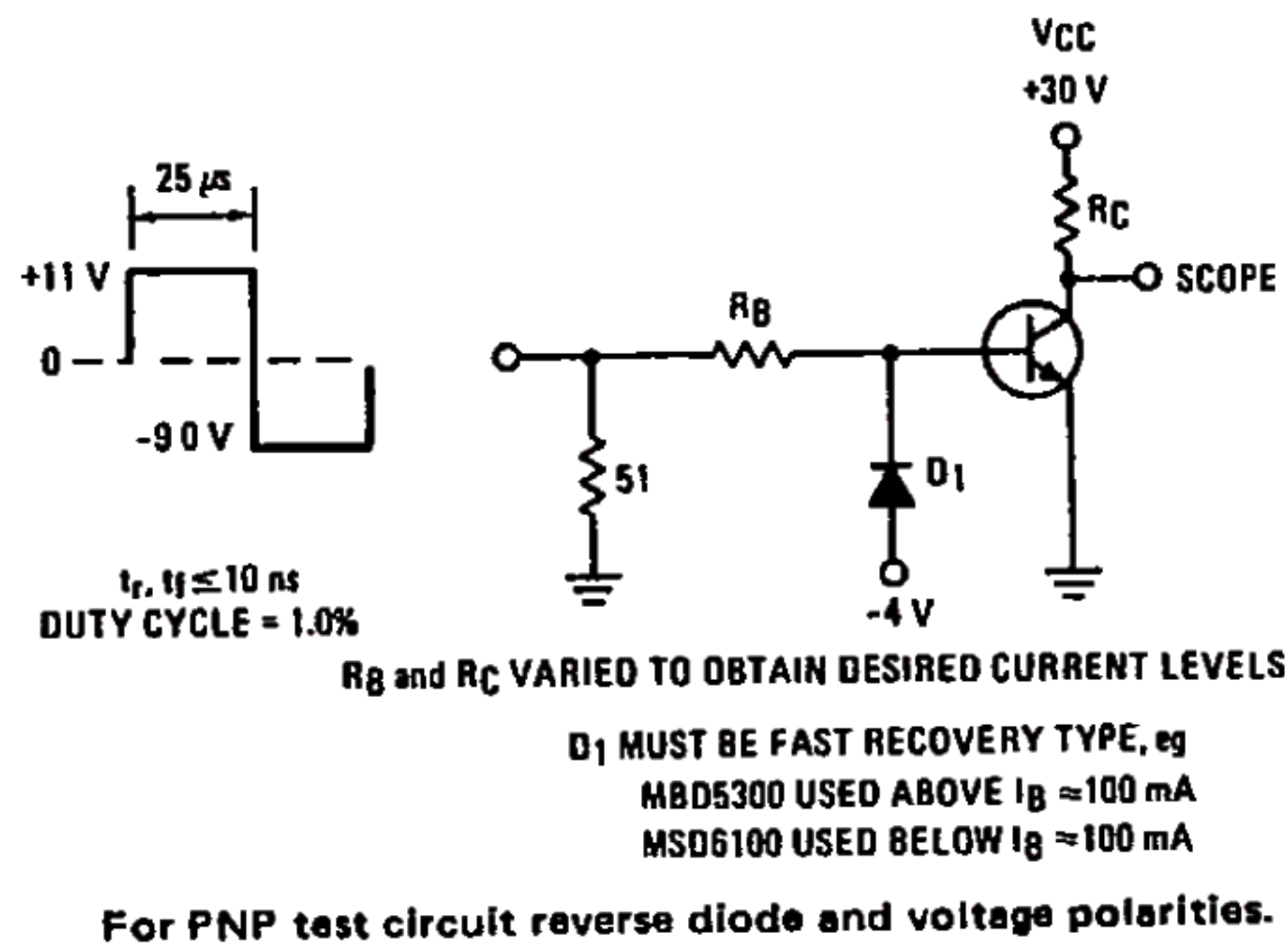
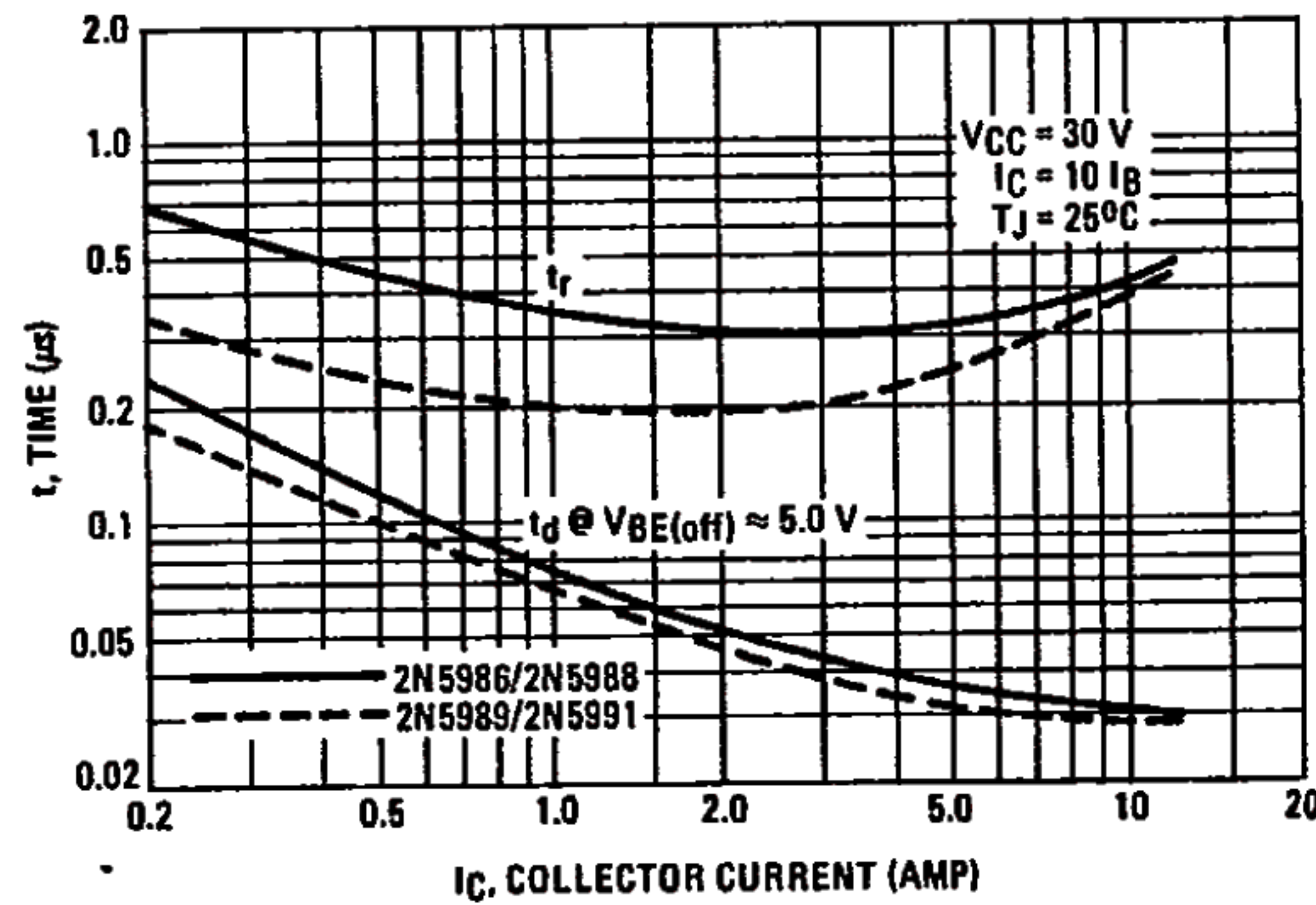

FIGURE 3 – TURN-ON TIME



6367254 MOTOROLA SC (XSTRS/R F)  
 2N5986, 2N5987, 2N5988 PNP / 2N5989, 2N5991 NPN

FIGURE 4 - THERMAL RESPONSE

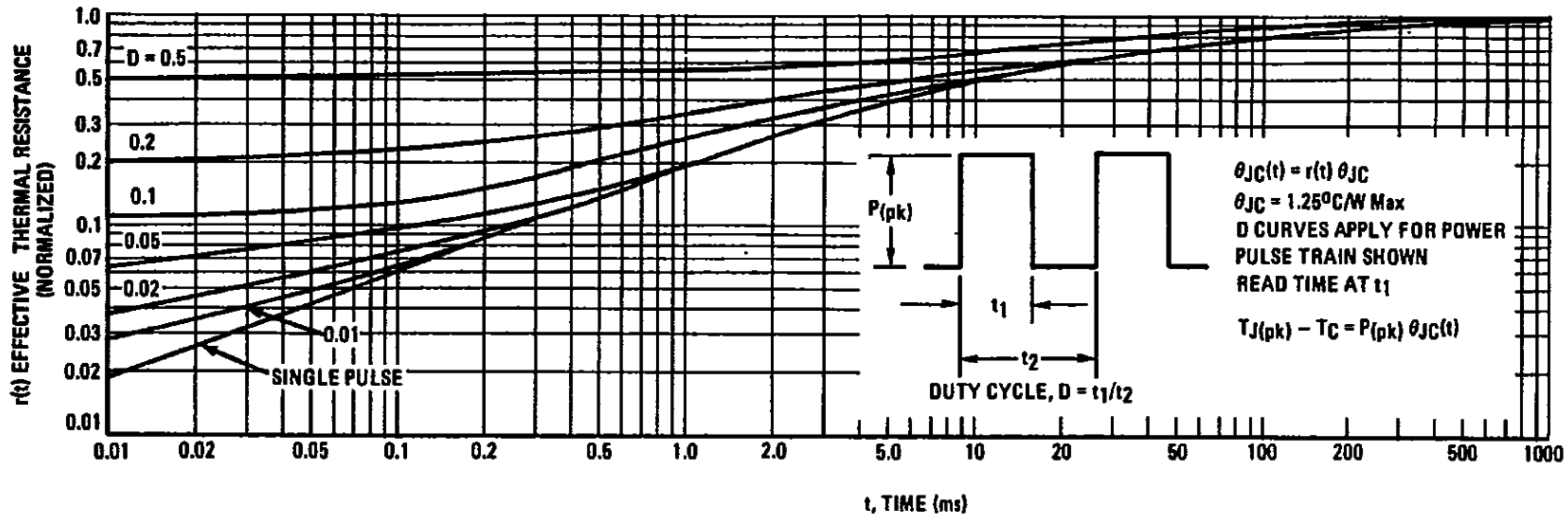
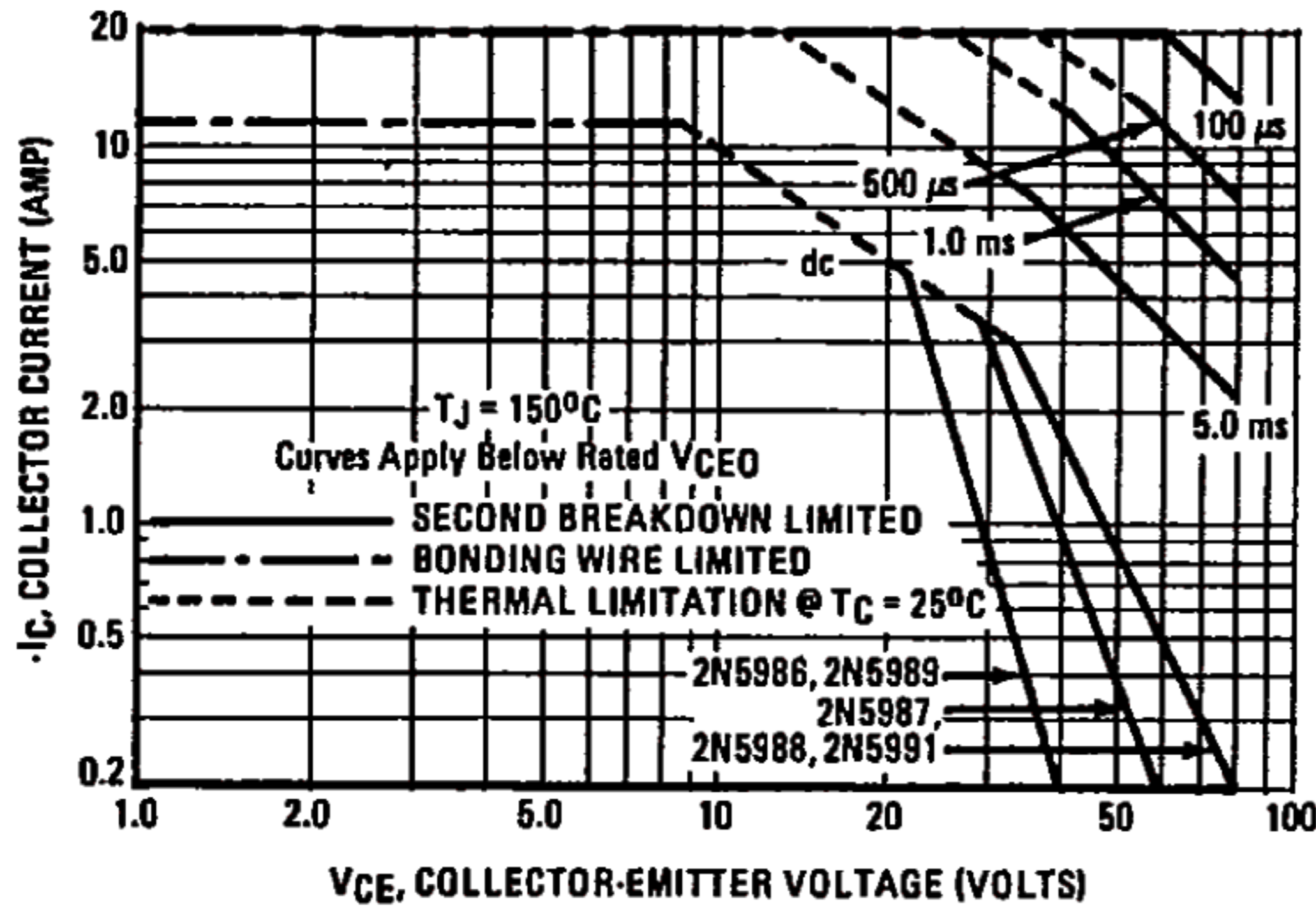

FIGURE 5 - ACTIVE-REGION SAFE OPERATING AREA



There are two limitations on the power handling ability of a transistor: average junction temperature and second breakdown. Safe operating area curves indicate  $I_C - V_{CE}$  limits of the transistor that must be observed for reliable operation; i.e., the transistor must not be subjected to greater dissipation than the curves indicate.

The data of Figure 5 is based on  $T_J(pk) = 150^\circ C$ ;  $T_C$  is variable depending on conditions. Second breakdown pulse limits are valid for duty cycles to 10% provided  $T_J(pk) \leq 150^\circ C$ .  $T_J(pk)$  may be calculated from the data in Figure 4. At high case temperatures, thermal limitations will reduce the power that can be handled to values less than the limitations imposed by second breakdown.

FIGURE 6 - TURN-OFF TIME

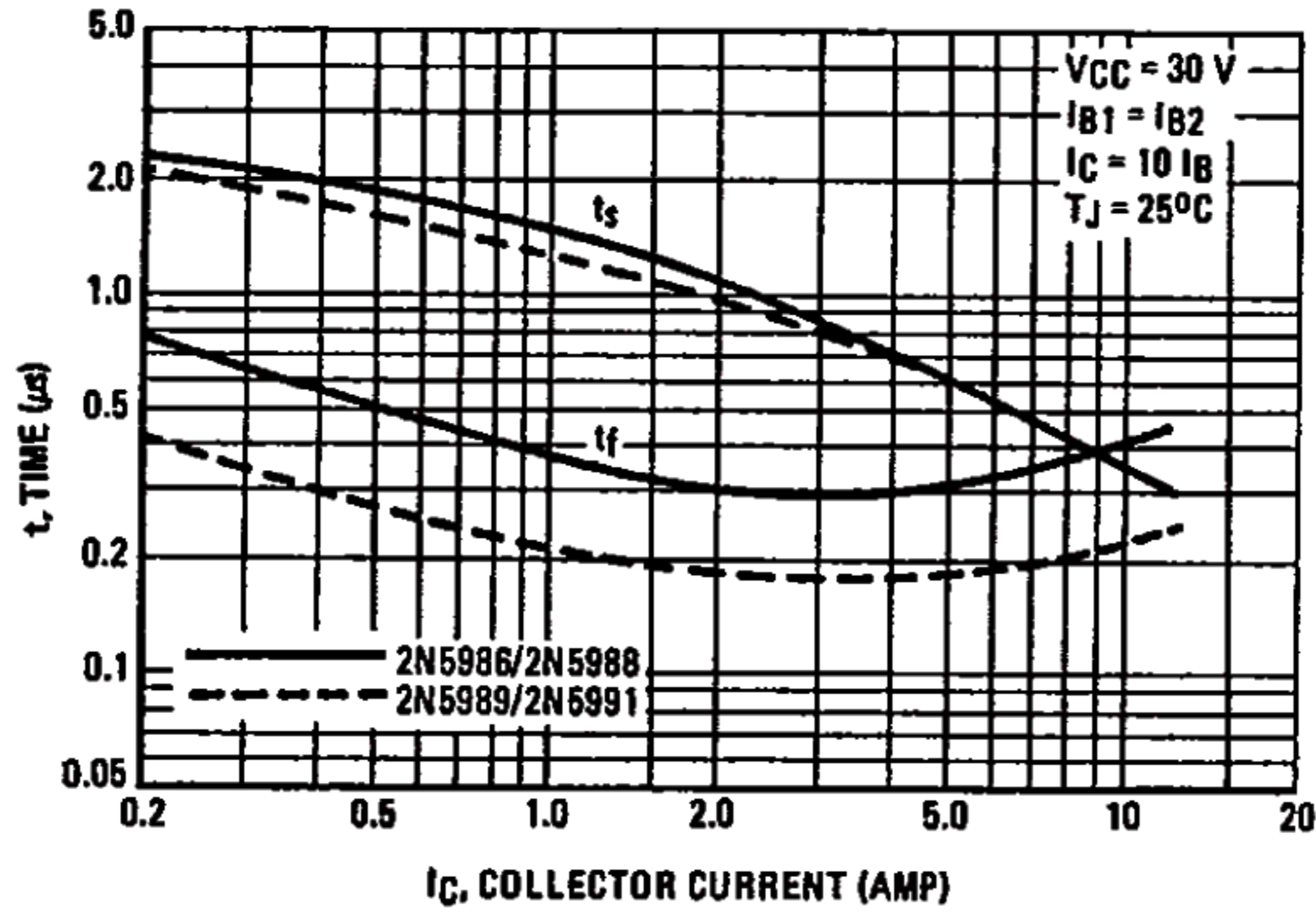
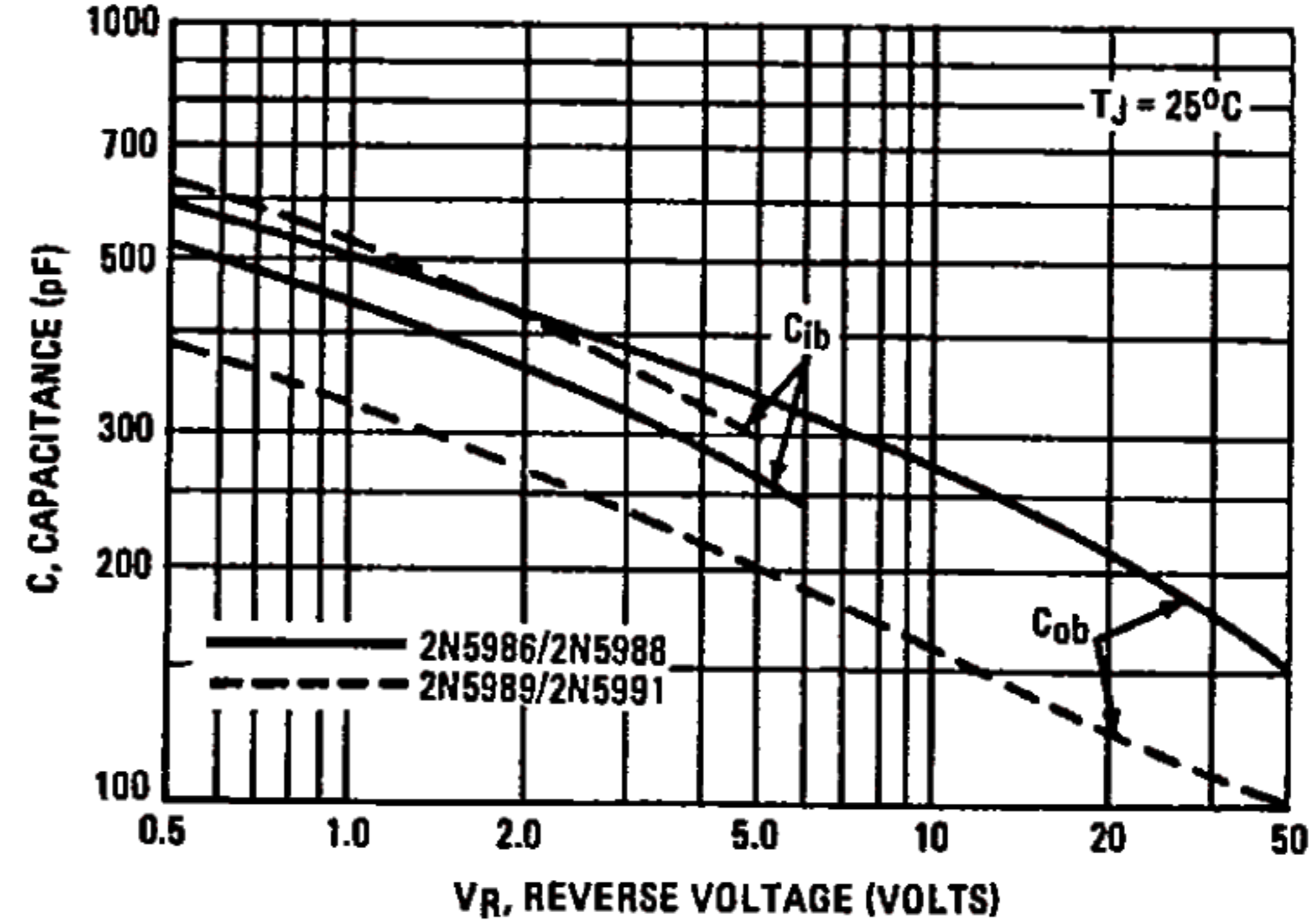

FIGURE 7 - CAPACITANCE



6367254 MOTOROLA - SC (XSTRS/R F)  
 2N5986, 2N5987, 2N5988 PNP / 2N5989, 2N5991 NPN

PNP  
 2N5986 thru 2N5988

NPN  
 2N5989, 2N5991

FIGURE 8 - DC CURRENT GAIN

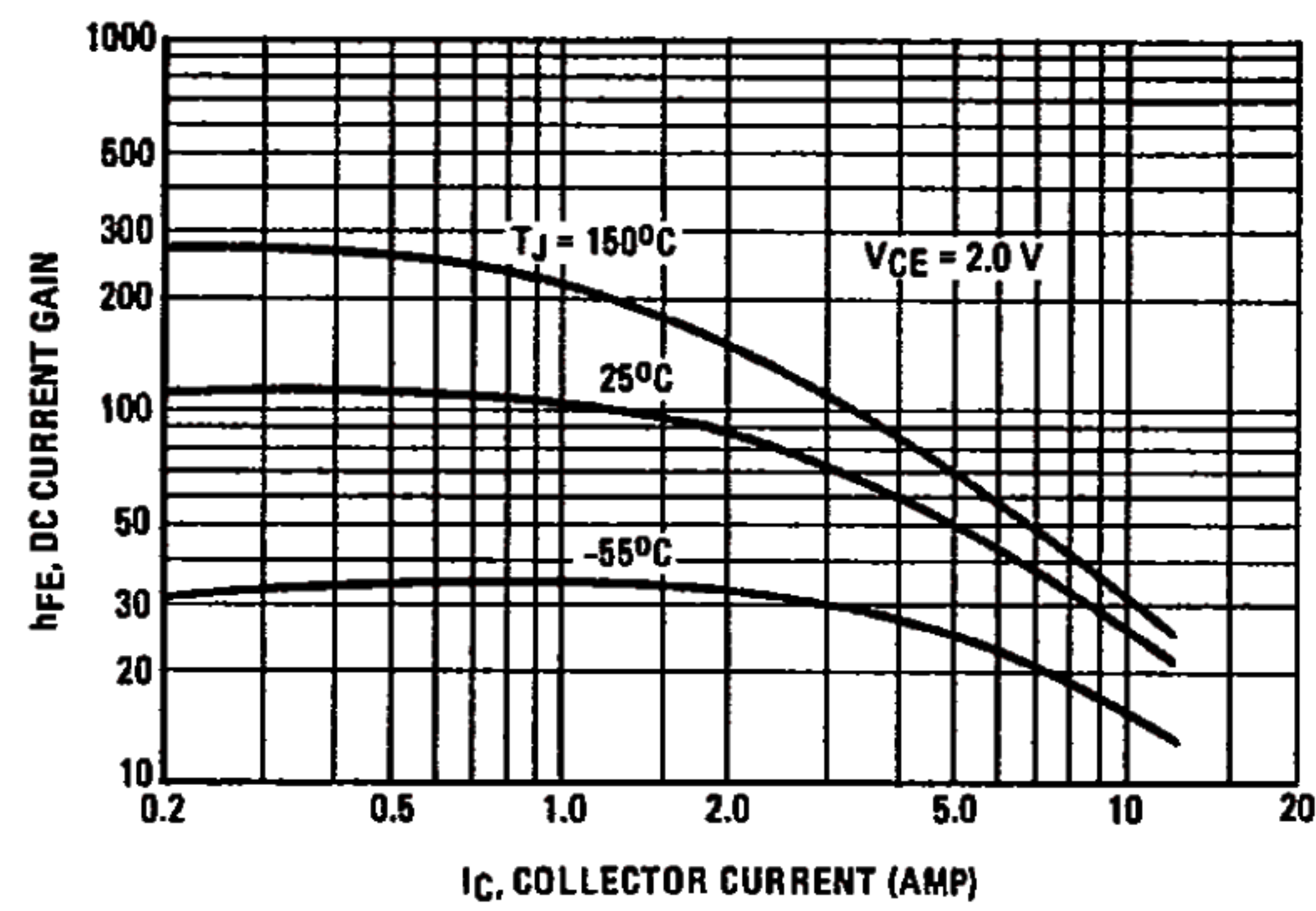
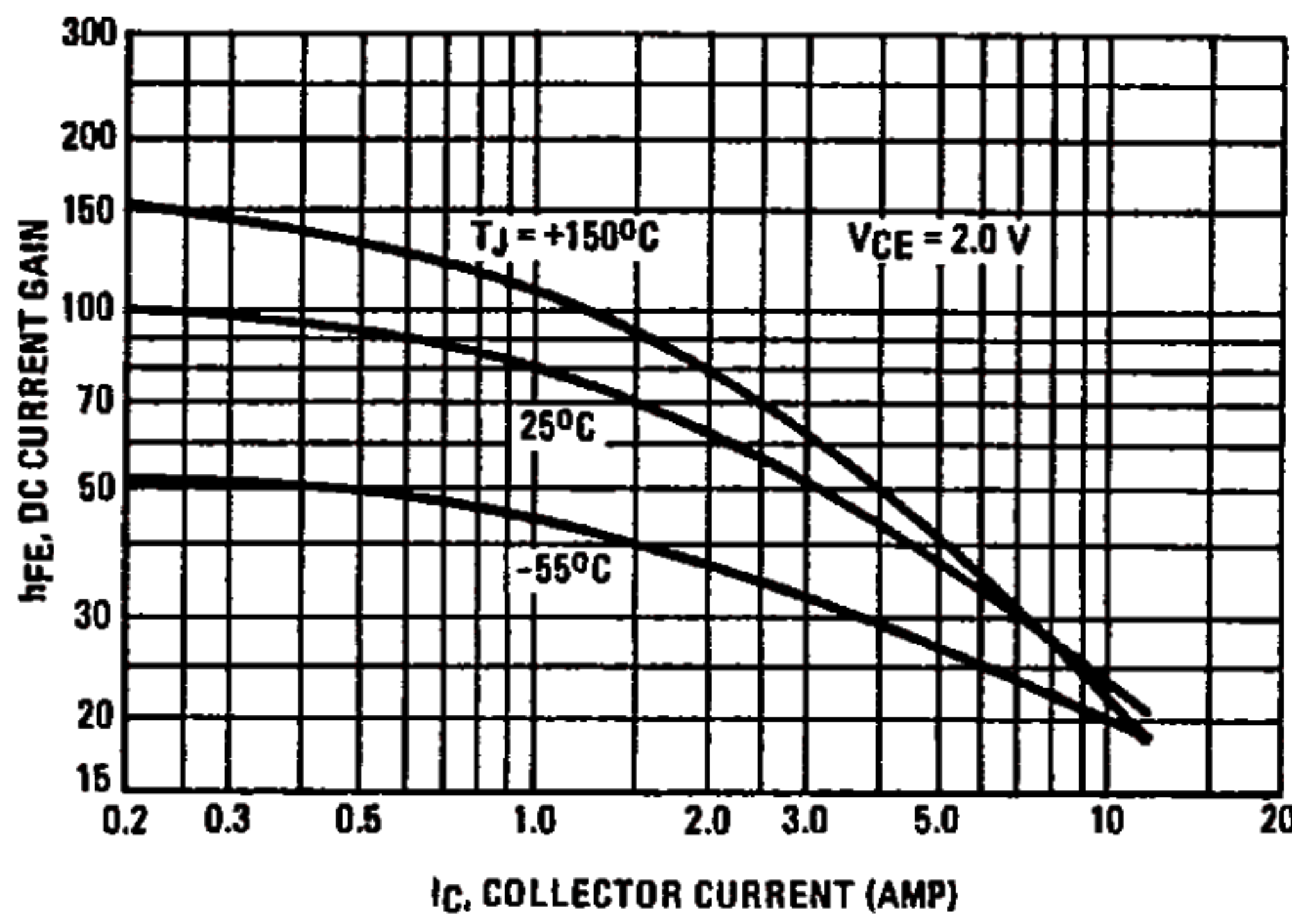

FIGURE 9 - COLLECTOR SATURATION REGION

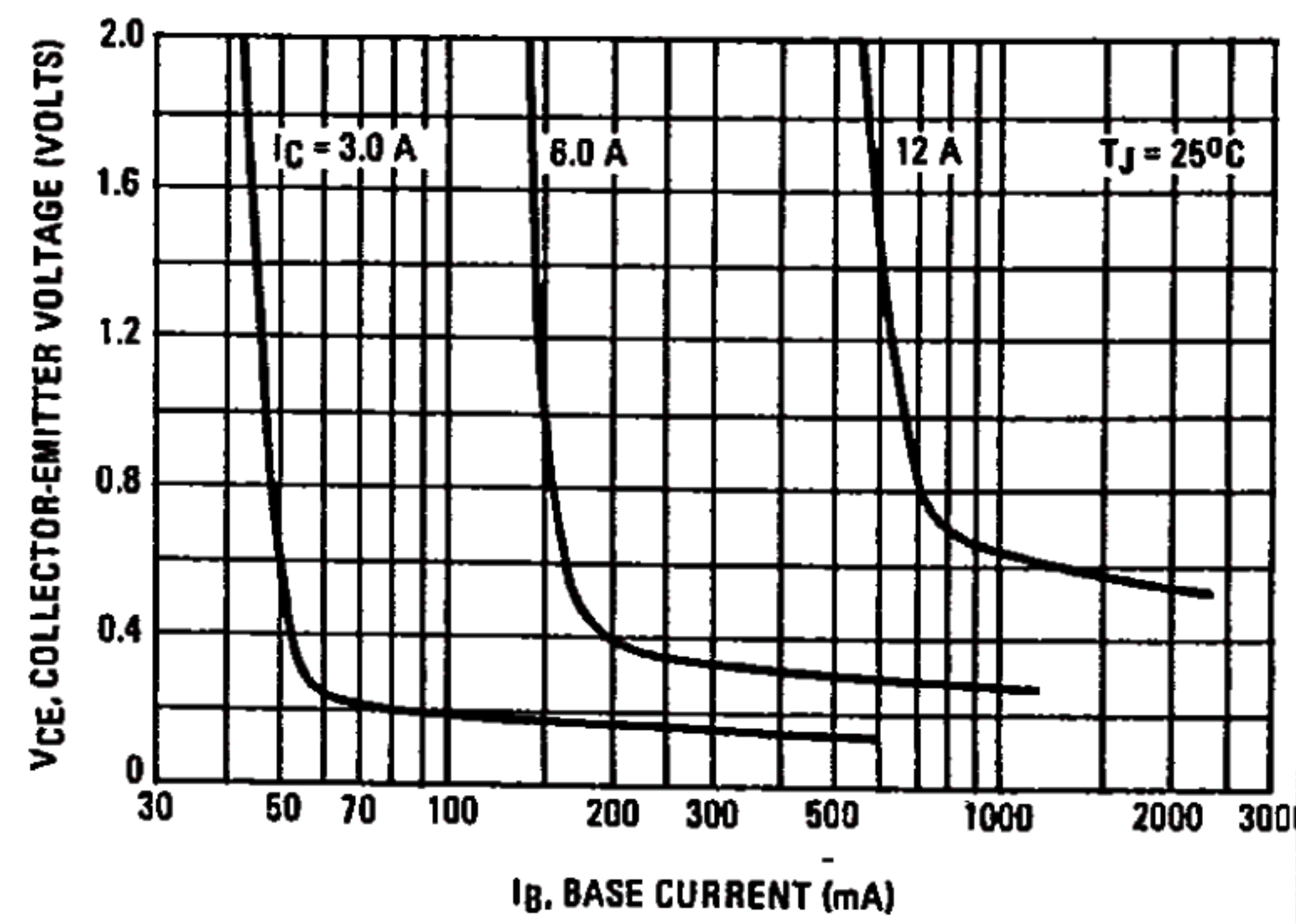
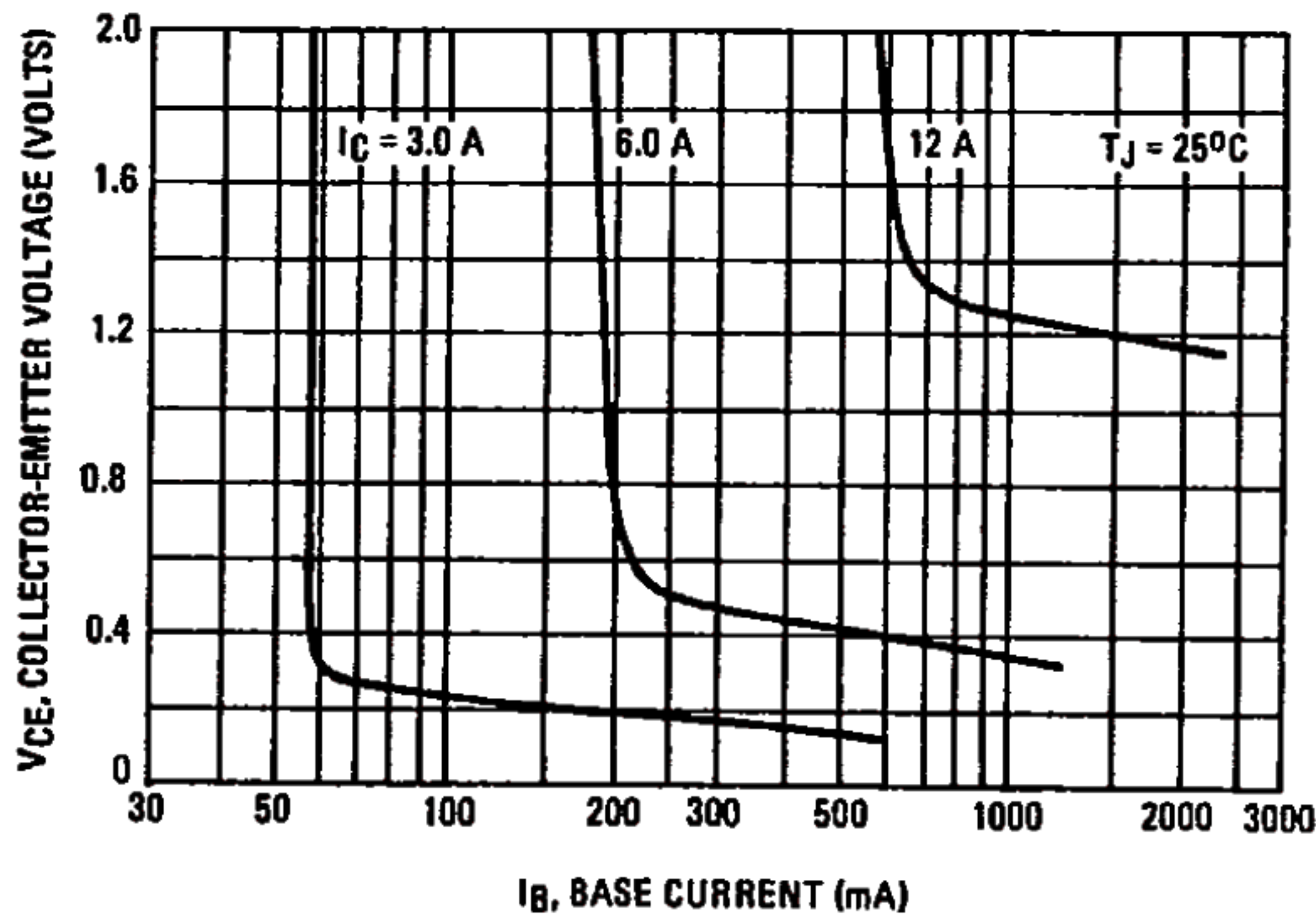
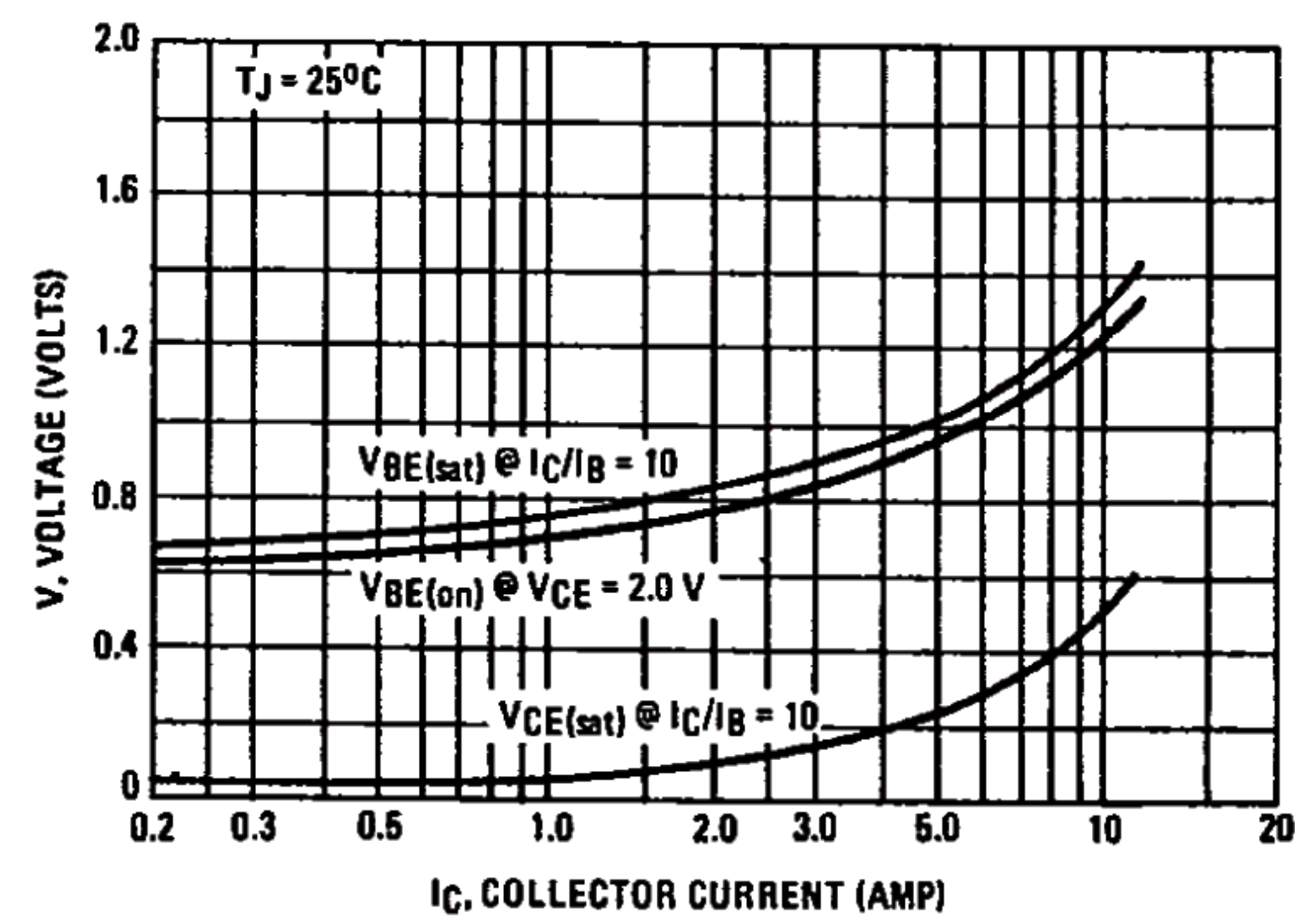
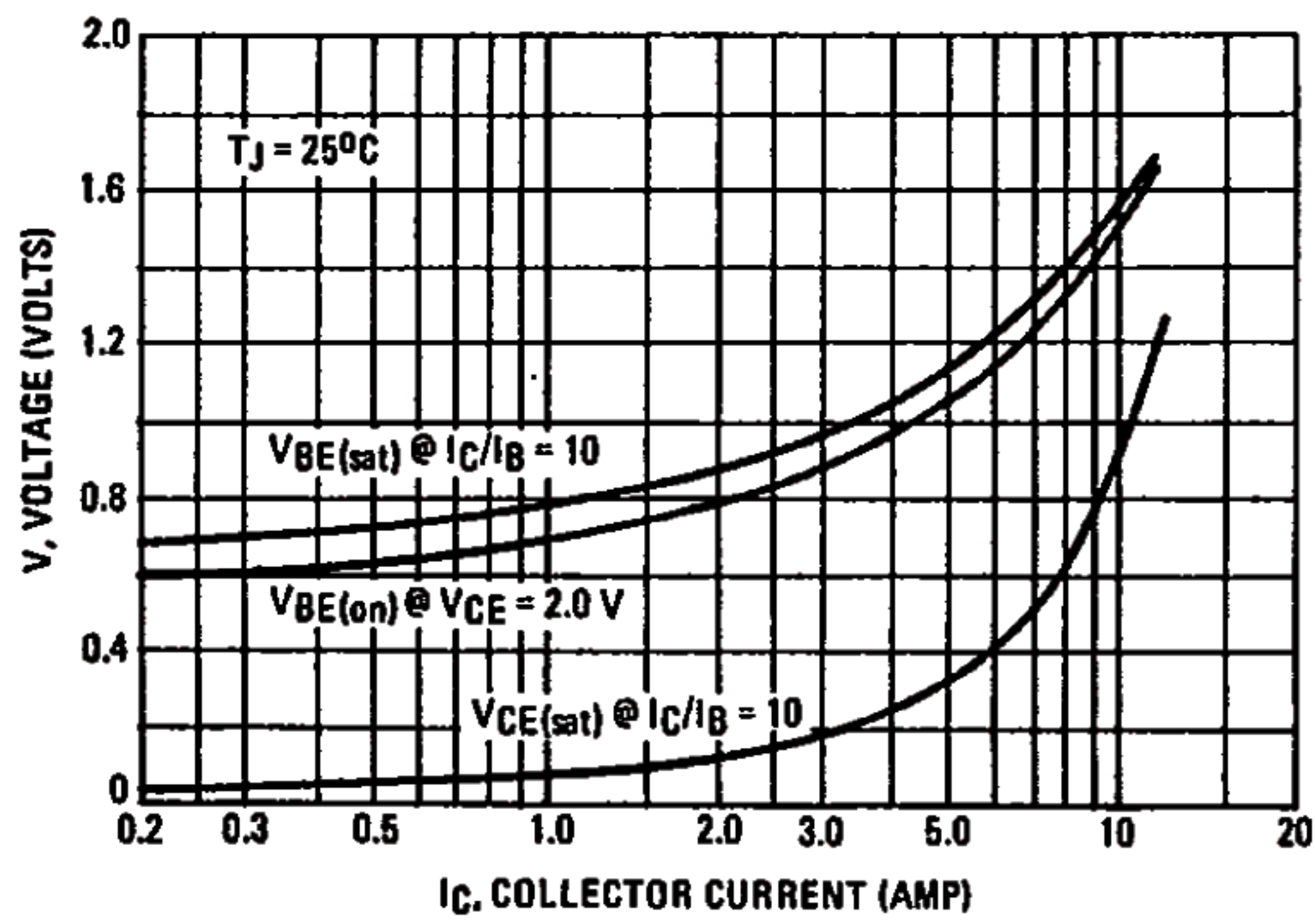

FIGURE 10 - "ON" VOLTAGES



This datasheet has been download from:

[www.datasheetcatalog.com](http://www.datasheetcatalog.com)

Datasheets for electronics components.