

Power management (dual digital transistors)

UMC5N / FMC5A

●Features

- 1) Both the DTA143X chip and DTZ144E chip in a UMT or SMT package.
- 2) Ideal for power switch circuits.
- 3) Mounting cost and area can be cut in half.

●Structure

Epitaxial planar type
NPN/PNP silicon transistor
(Built-in resistor type)

●External dimensions (Units: mm)

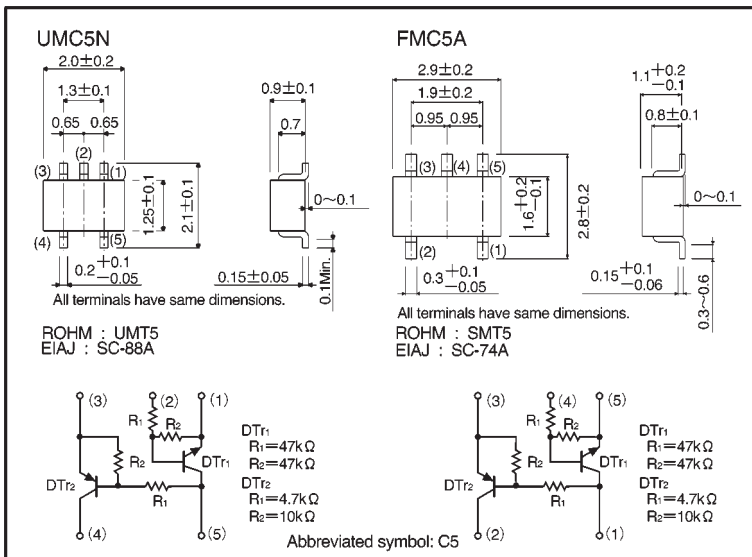

●Absolute maximum ratings (Ta = 25°C)

Parameter	Symbol	Limits		Unit
		DTr1 (NPN)	DTr2 (PNP)	
Supply voltage	V _{CC}	50	-50	V
Input voltage	V _{IN}	40	-20	V
		-10	7	
Output current	I _{O(Max.)}	30	-100	mA
	I _{C(Max.)}	100	-100	
Power dissipation	UMC5N	150 (TOTAL)		mW
	FMC5A	300 (TOTAL)		
Junction temperature	T _j	150		°C
Storage temperature	T _{stg}	-55~+150		°C

*1 120mW per element must not be exceeded.

*2 200mW per element must not be exceeded.

● Electrical characteristics, DTr₁ (Ta = 25°C)

Parameter	Symbol	Min.	Typ.	Max.	Unit	Conditions
Input voltage	V _{I(off)}	—	—	0.5	V	V _{CC} =5V, I _o =100 μA
	V _{I(on)}	3	—	—		V _o =0.3V, I _o =2mA
Output voltage	V _{O(on)}	—	0.1	0.3	V	I _o =10mA, I _i =0.5mA
Input current	I _i	—	—	0.18	mA	V _i =5V
Output current	I _{O(off)}	—	—	0.5	μA	V _{CC} =50V, V _i =0V
DC current gain	G _i	68	—	—	—	V _o =5V, I _o =5mA
Transition frequency	f _T	—	250	—	MHz	V _{CE} =10mA, I _E =-5mA, f=100MHz *
Input resistance	R ₁	32.9	47	61.1	kΩ	—
Resistance ratio	R ₂ /R ₁	0.8	1	1.2	—	—

* Transition frequency of the device

● Electrical characteristics, DTr₂ (Ta = 25°C)

Parameter	Symbol	Min.	Typ.	Max.	Unit	Conditions
Input voltage	V _{I(off)}	—	—	-0.3	V	V _{CC} =-5V, I _o =-100 μA
	V _{I(on)}	-2.5	—	—		V _o =-0.3V, I _o =-20mA
Output voltage	V _{O(on)}	—	-0.1	-0.3	V	I _o =-10mA, I _i =-0.5mA
Input current	I _i	—	—	-1.8	mA	V _i =-5V
Output current	I _{O(off)}	—	—	-0.5	μA	V _{CC} =-50V, V _i =0V
DC current gain	G _i	30	—	—	—	V _o =-5V, I _o =-10mA
Transition frequency	f _T	—	250	—	MHz	V _{CE} =-10mA, I _E =5mA, f=100MHz *
Input resistance	R ₁	3.29	4.7	6.11	kΩ	—
Resistance ratio	R ₂ /R ₁	1.7	2.1	2.6	—	—

* Transition frequency of the device

● Packaging specifications

Part No.	Packaging type	Taping	
	Code	TR	T148
	Basic ordering unit (pieces)	3000	3000
UMC5N		○	—
FMC5A		—	○

● Electrical characteristic curves

DT_{r1} (NPN)

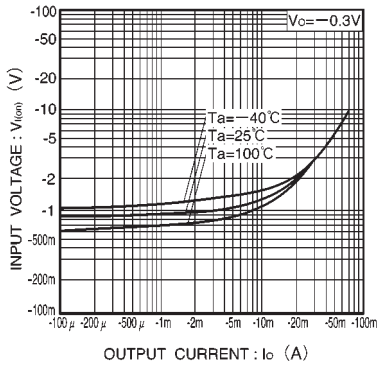

Fig.5 Input voltage vs. output current (ON characteristics)

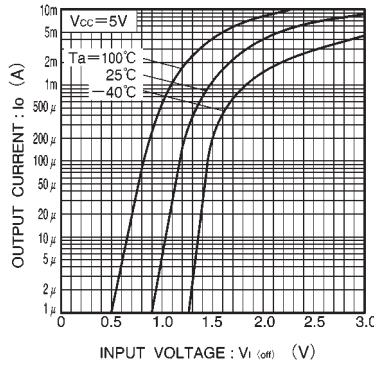

Fig.2 Output current vs. input voltage (OFF characteristics)

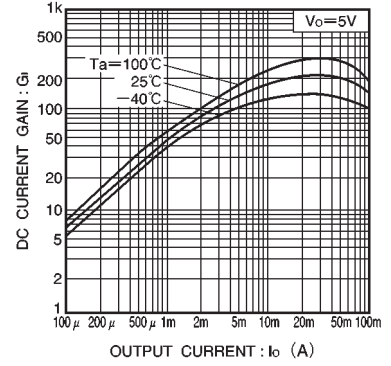

Fig.3 DC current gain vs. output current

DT_{r2} (PNP)

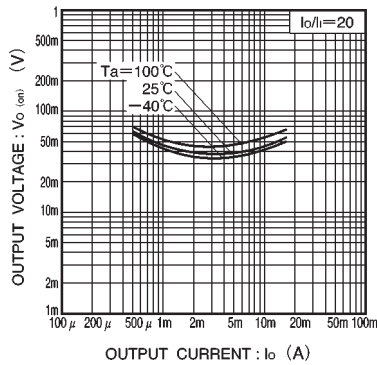

Fig.4 Output voltage vs. output current

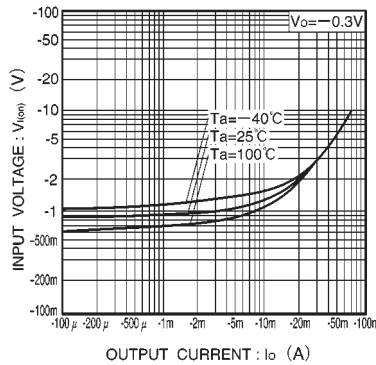

Fig.5 Input voltage vs. output current (ON characteristics)

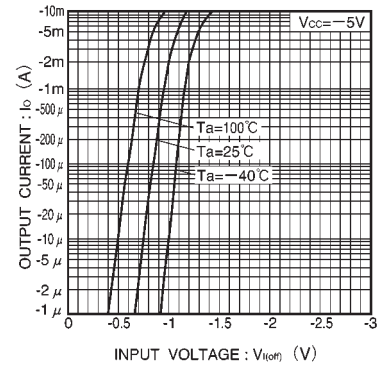

Fig.6 Output current vs. input voltage (OFF characteristics)

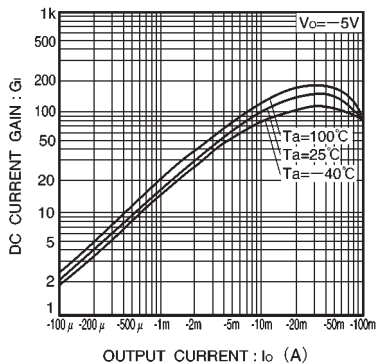

Fig.7 DC current gain vs. output current

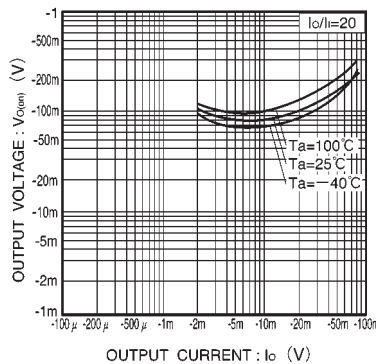

Fig.8 Output voltage vs. output current