

MITSUBISHI ELEK (LINEAR) 80 DE 6249826 0009205 2 **M54516P**

6249826 MITSUBISHI ELEK (LINEAR) 80C 09205 D T-43-25

5-UNIT 500mA DARLINGTON TRANSISTOR ARRAY

DESCRIPTION

The M54516P, 5-channel sink driver, consists of 10 NPN transistors connected to form five high current gain driver pairs.

FEATURES

- Output sustaining voltage to 25 V
- High output sink current to 500mA
- PMOS Compatible input
- Wide operating temperature range ($T_a = -20 \sim +75^\circ\text{C}$)

APPLICATION

Relay and printer driver, LED or incandescent display digit driver, interfacing for standard MOS/BIPOLAR logics.

FUNCTION

The M54516P is comprised of five NPN darlington driver pairs with $20\text{k}\Omega$ series input resistors. All emitter and the substrate are connected together to pin 7. The output are capable of sinking 500mA and will withstand 25V in the OFF state.

PIN CONFIGURATION (TOP VIEW)

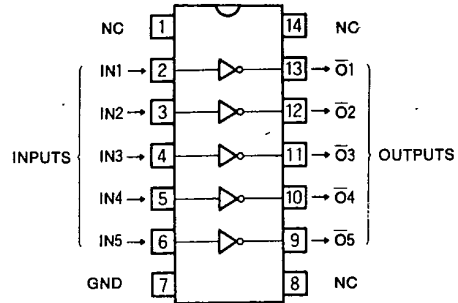

Outline 14P4

NC : NO CONNECTION

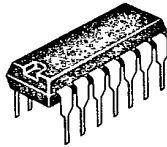

14-pin molded plastic DIP

CIRCUIT SCHEMATIC

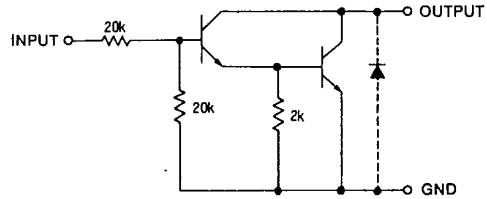

Unit : Ω

ABSOLUTE MAXIMUM RATINGS ($T_a = -20 \sim +75^\circ\text{C}$, unless otherwise noted)

Symbol	Parameter	Conditions	Rating	Unit
V_{CE0}	Output sustaining voltage	Transistor OFF	$-0.5 \sim +25$	V
I_C	Collector current	Transistor ON	500	mA
V_I	Input voltage		25	V
P_d	Power dissipation	$T_a = 25^\circ\text{C}$	1.47	W
T_{opr}	Operating ambient temperature range		$-20 \sim +75$	$^\circ\text{C}$
T_{stg}	Storage temperature range		$-55 \sim +125$	$^\circ\text{C}$

MITSUBISHI ELEK {LINEAR} 80 DE 6249826 0009206 4 M54516P

6249826 MITSUBISHI ELEK (LINEAR) 80C 09206 D T-43-25

5-UNIT 500mA DARLINGTON TRANSISTOR ARRAY

RECOMMENDED OPERATIONAL CONDITIONS (T_a = -20~+75°C, unless otherwise noted)

Symbol	Parameter	Limits			Unit
		Min	Typ	Max	
V _O	Output voltage	0		25	V
I _C	Collector current per channel	Percent duty cycle less than 10%	0	400	mA
		Percent duty cycle less than 55%	0	200	
V _{IH}	"H" Input voltage	I _C =400mA	8	20	V
		I _C =200mA	5	20	
V _{IL}	"L" Input voltage	I _{OL(Leak)} =50μA	0	0.5	V

ELECTRICAL CHARACTERISTICS (T_a = -20~+75°C, unless otherwise noted)

Symbol	Parameter	Test conditions	Limits			Unit
			Min	Typ	Max	
V _{(BR)CEO}	Output sustaining voltage	I _{CEO} =100μA	25			V
V _{CE(sat)}	Output saturation voltage	V _I =8V, I _C =400mA		1.15	2.2	V
		V _I =5V, I _C =200mA		0.95	1.4	
I _I	Input current	V _I =17V		0.8	1.8	mA
h _{FE}	DC forward current gain	V _{CE} =4V, I _C =400mA, T _a =25°C	1000	4000		—

* : A typical value is at T_a=25°C.

TYPICAL CHARACTERISTICS

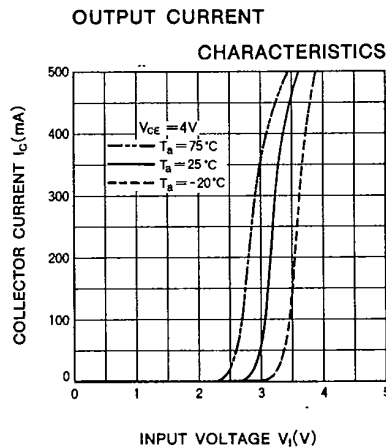
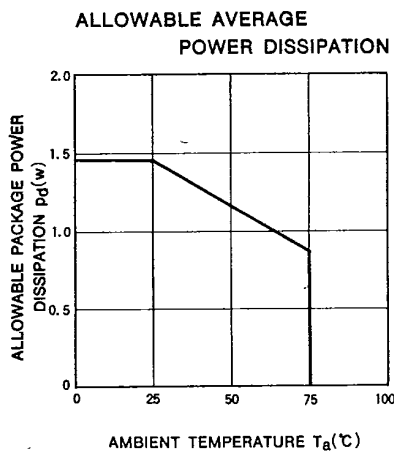

ALLOWABLE COLLECTOR CURRENT AS A FUNCTION OF DUTY CYCLE

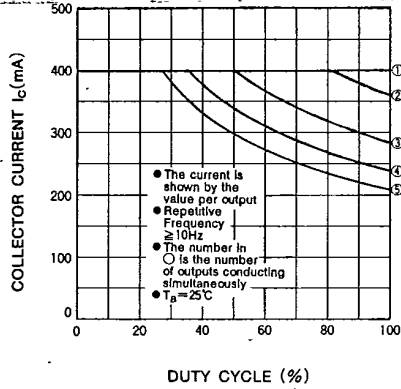

ALLOWABLE COLLECTOR CURRENT AS A FUNCTION OF DUTY CYCLE

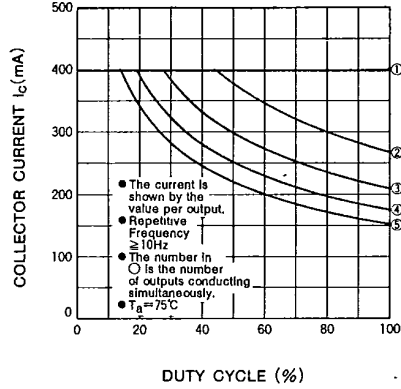

DC CURRENT GAIN CHARACTERISTICS

