

# SHINDENGEN

## Schottky Rectifiers (SBD)

Dual

# SF30SC3L

## 30V 30A

### FEATURES

- Tj150
- Low  $V_F=0.45V$
- $P_{RRSM}$  avalanche guaranteed
- Fully Isolated Molding
- Dielectric strength 2kV guaranteed

### APPLICATION

- Switching power supply
- DC/DC converter
- Home Appliances, Office Equipment
- Telecommunication

### OUTLINE DIMENSIONS

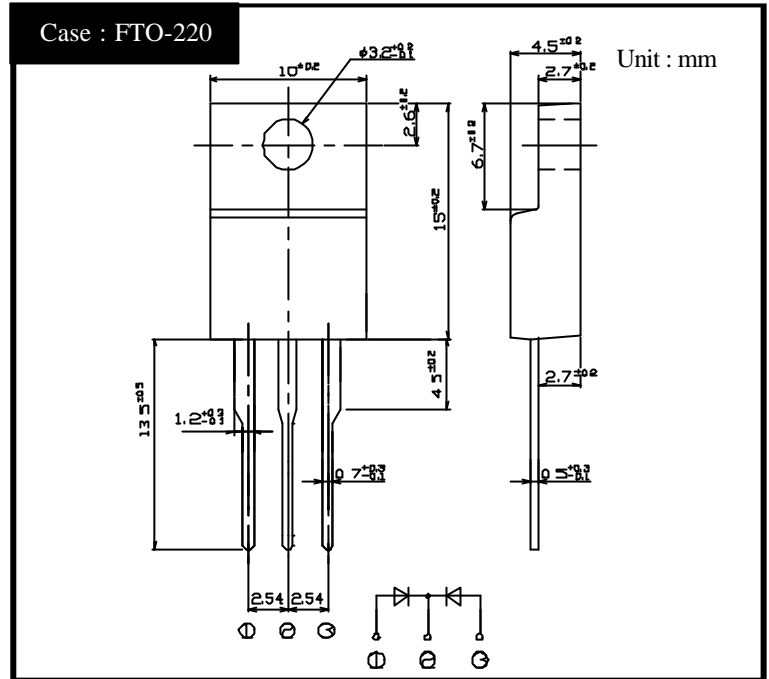

### RATINGS

Absolute Maximum Ratings (If not specified  $T_c=25$  )

Item	Symbol	Conditions	Ratings	Unit
Storage Temperature	$T_{stg}$		-55 ~ 150	
Operating Junction Temperature	$T_j$		150	
Maximum Reverse Voltage	$V_{RM}$		30	V
Repetitive Peak Surge Reverse Voltage	$V_{RRSM}$	Pulse width 0.5ms, duty 1/40	35	V
Average Rectified Forward Current	$I_O$	50Hz sine wave, R-load, Rating for each diode $I_O/2$ , $T_c=111$	30	A
Peak Surge Forward Current	$I_{FSM}$	50Hz sine wave, Non-repetitive 1 cycle peak value, $T_j=25$	350	A
Repetitive Peak Surge Reverse Power	$P_{RRSM}$	Pulse width 10 $\mu$ s, Rating of per diode, $T_j=25$	1000	W
Dielectric Strength	$V_{dis}$	Terminals to case, AC 1 minute	2	kV
Mounting Torque	TOR	(Recommended torque 0.3N·m)	0.5	N·m

Electrical Characteristics (If not specified  $T_c=25$  )

Item	Symbol	Conditions	Ratings	Unit
Forward Voltage	$V_F$	$I_F=12.5A$ , Pulse measurement, Rating of per diode	Max.0.45	V
Reverse Current	$I_R$	$V_R=V_{RM}$ , Pulse measurement, Rating of per diode	Max.15	mA
Junction Capacitance	$C_j$	$f=1MHz$ , $V_R=10V$ , Rating of per diode	Typ.960	pF
Thermal Resistance	$\theta_{jc}$	junction to case	Max.2.0	/W

# SF30SC3L Forward Voltage

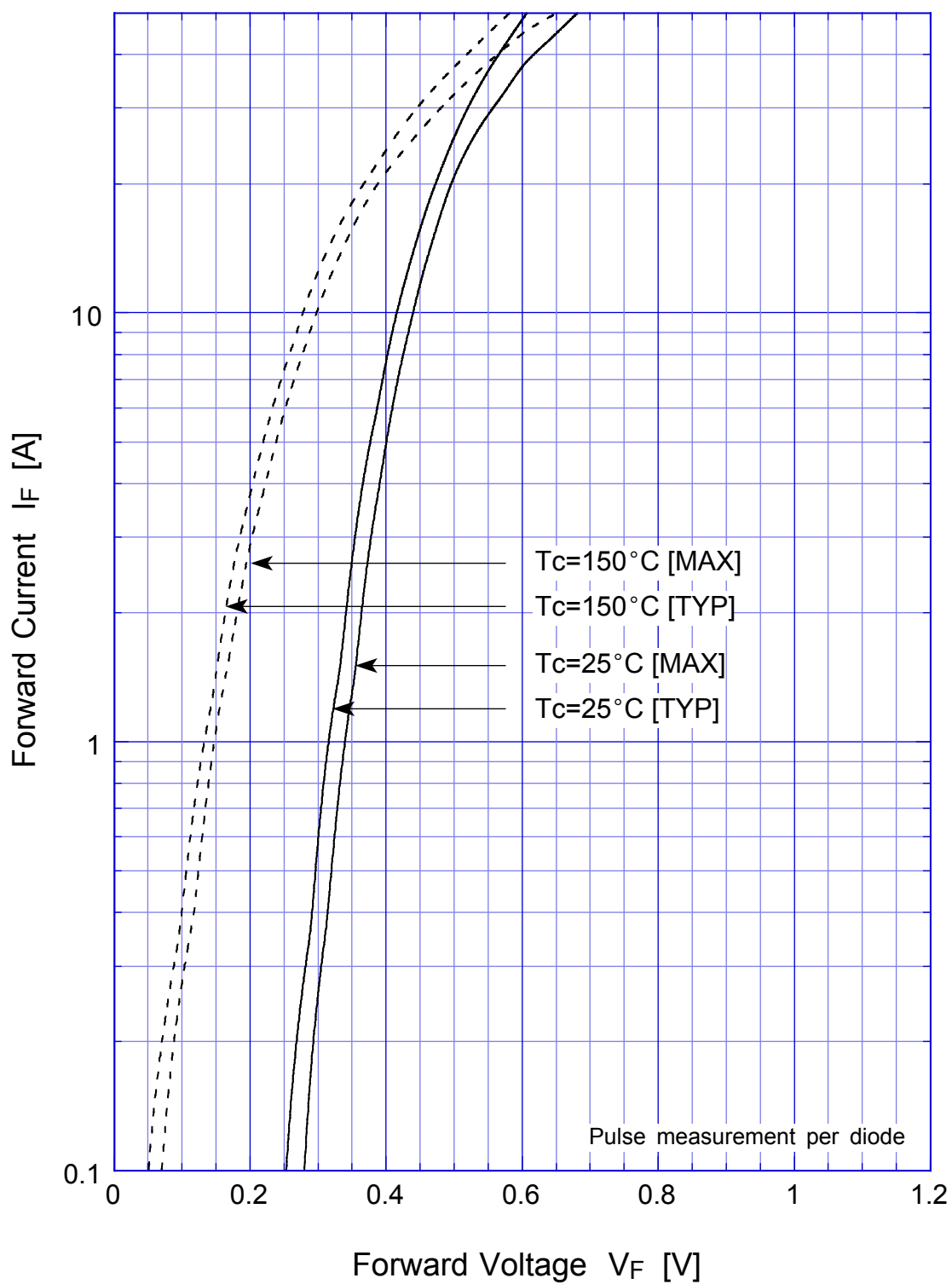

# SF30SC3L Junction Capacitance

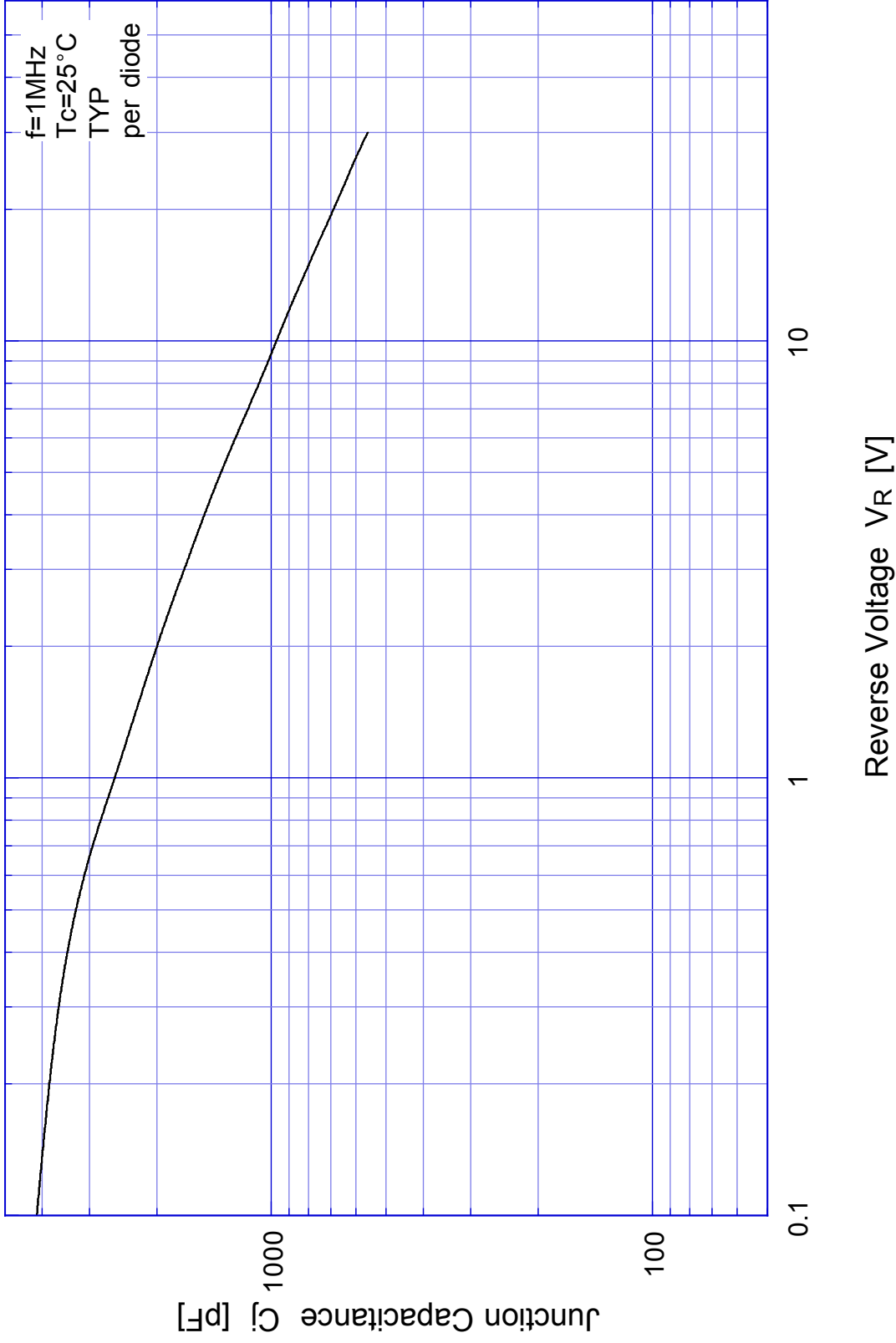

# SF30SC3L Reverse Current

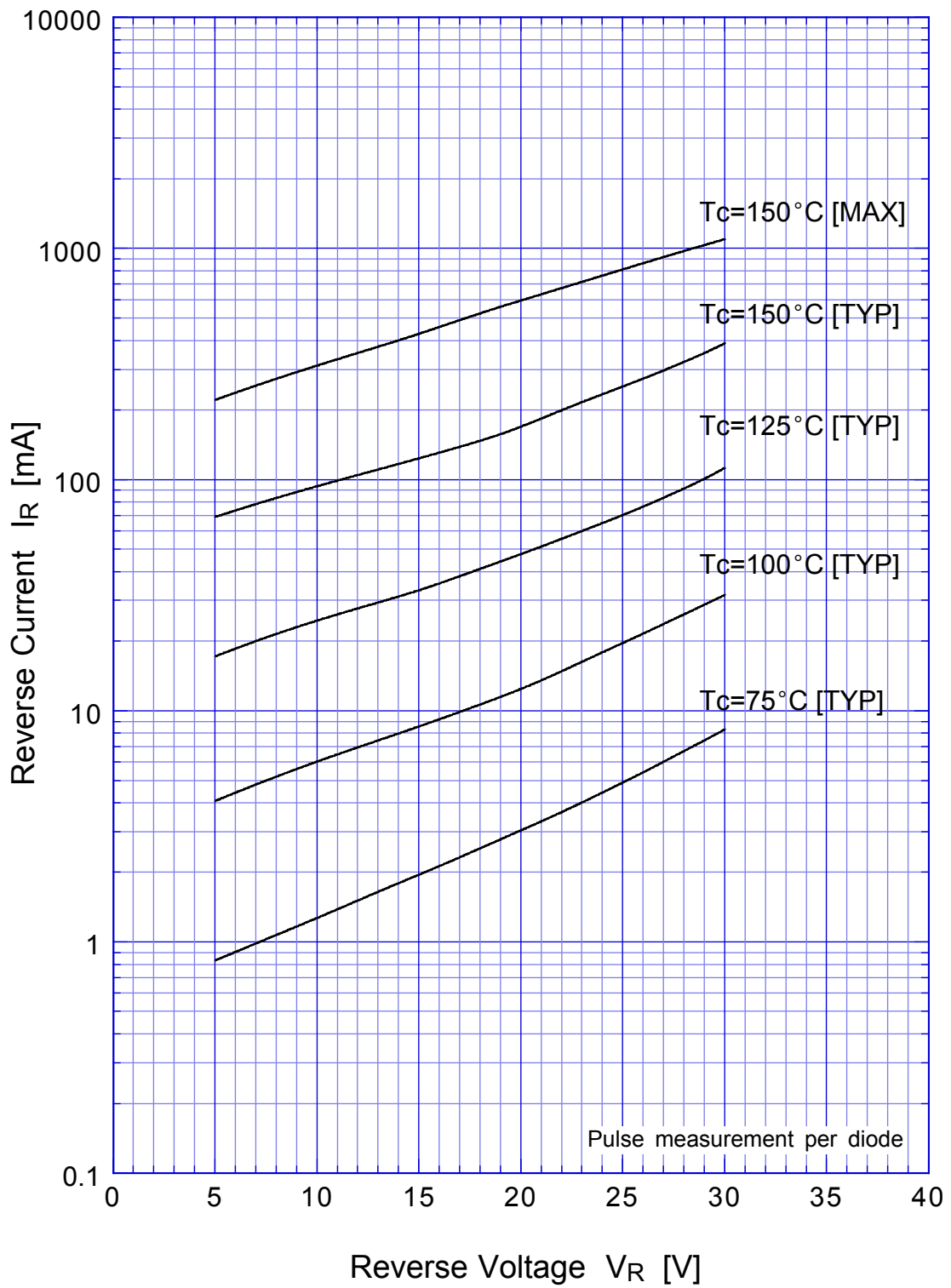

# SF30SC3L Reverse Power Dissipation

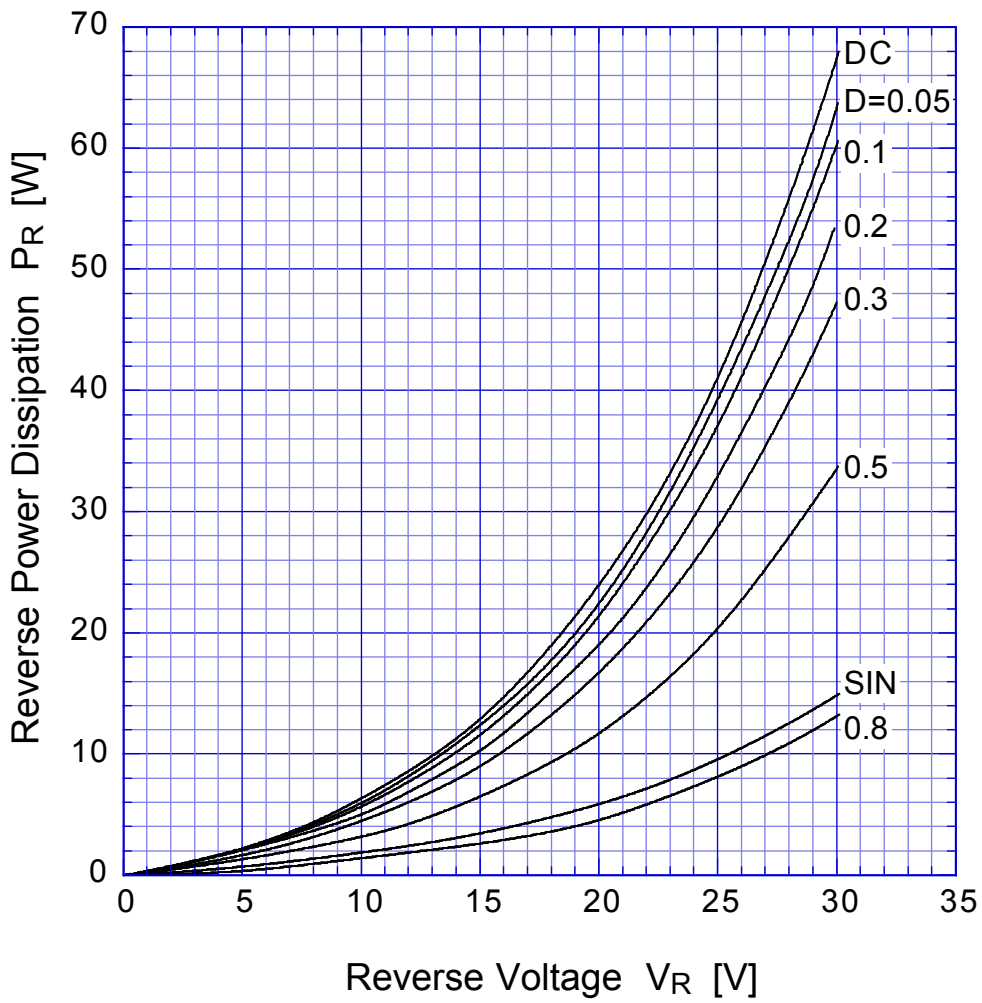

$T_j = 150^\circ\text{C}$

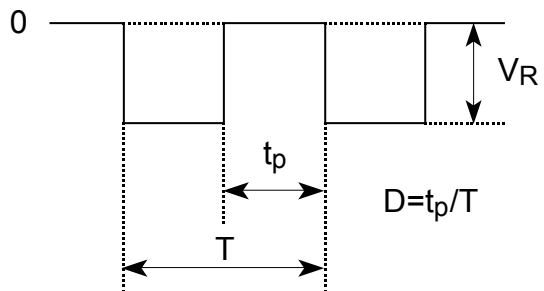

# SF30SC3L Forward Power Dissipation

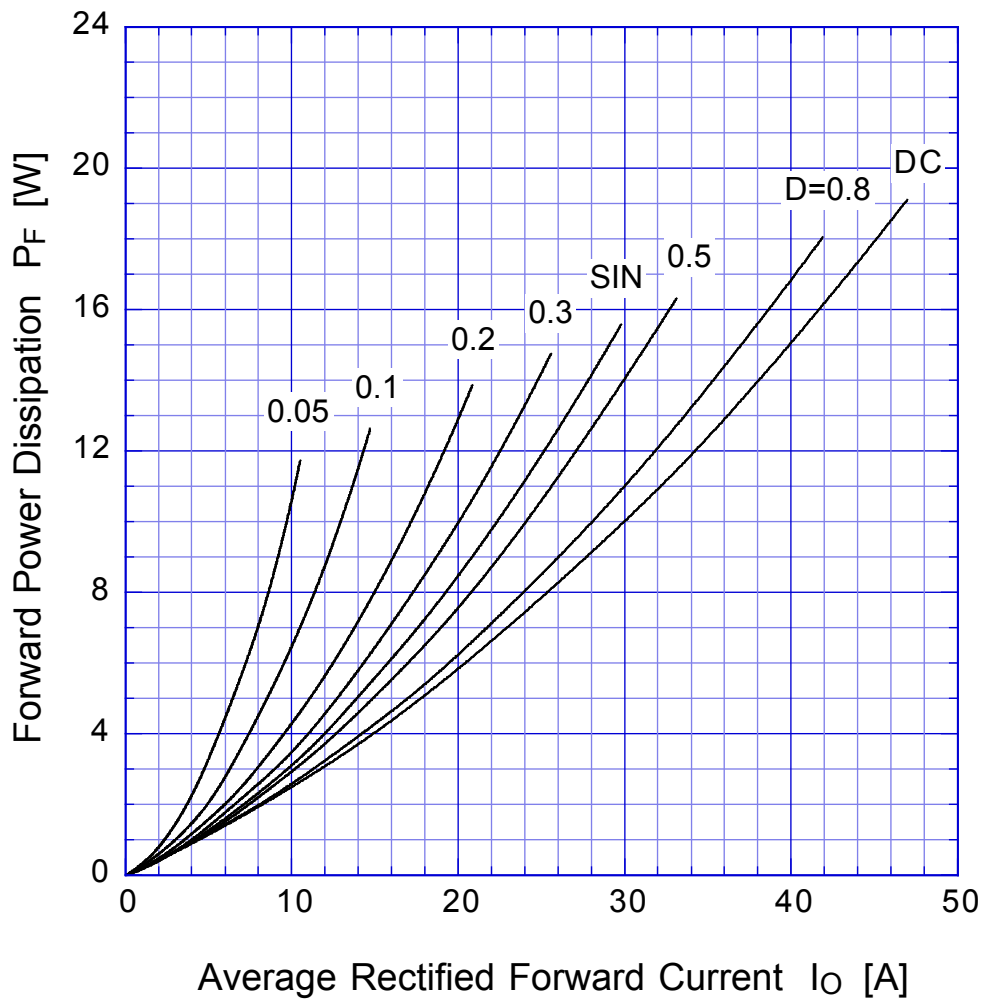

$T_j = 150^\circ\text{C}$

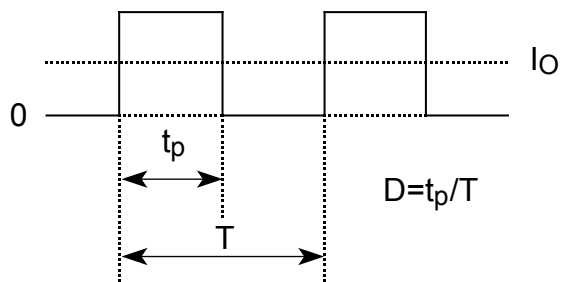

# SF30SC3L

# Derating Curve

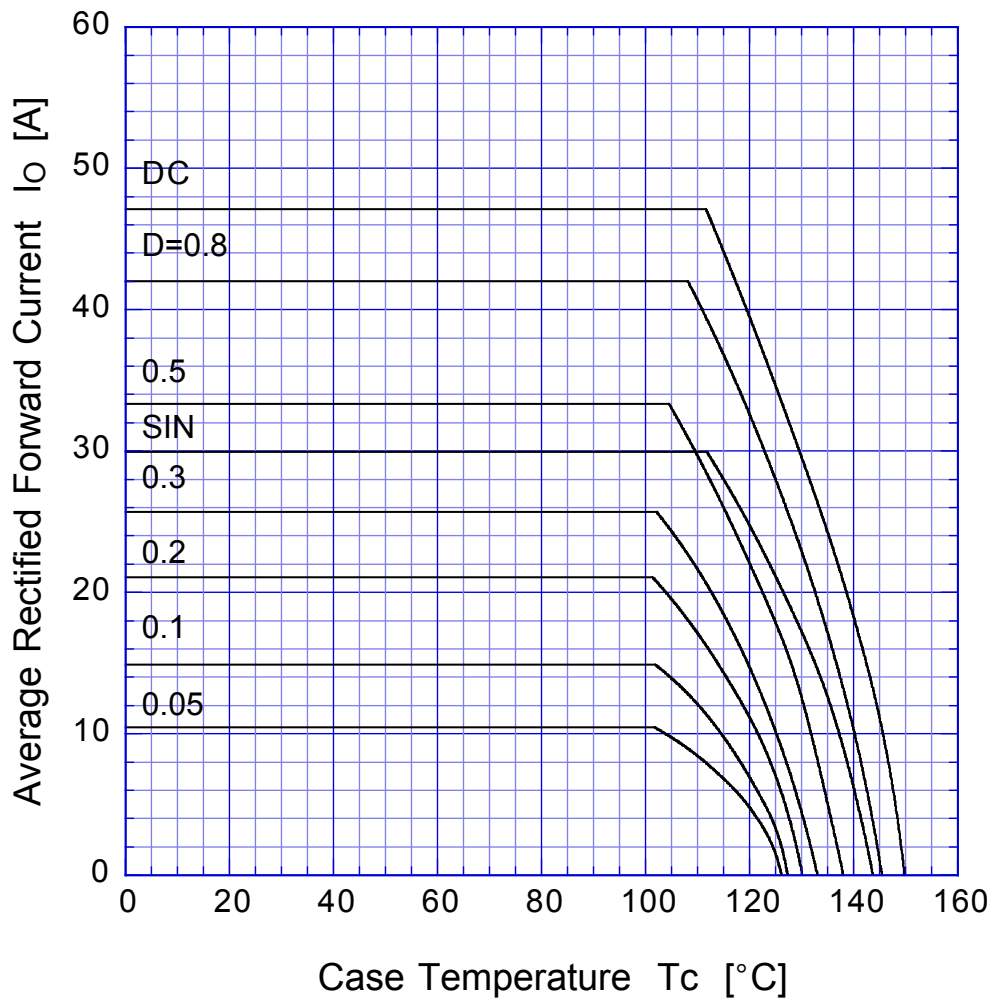

$V_R = 15V$



# SF30SC3L Peak Surge Forward Capability

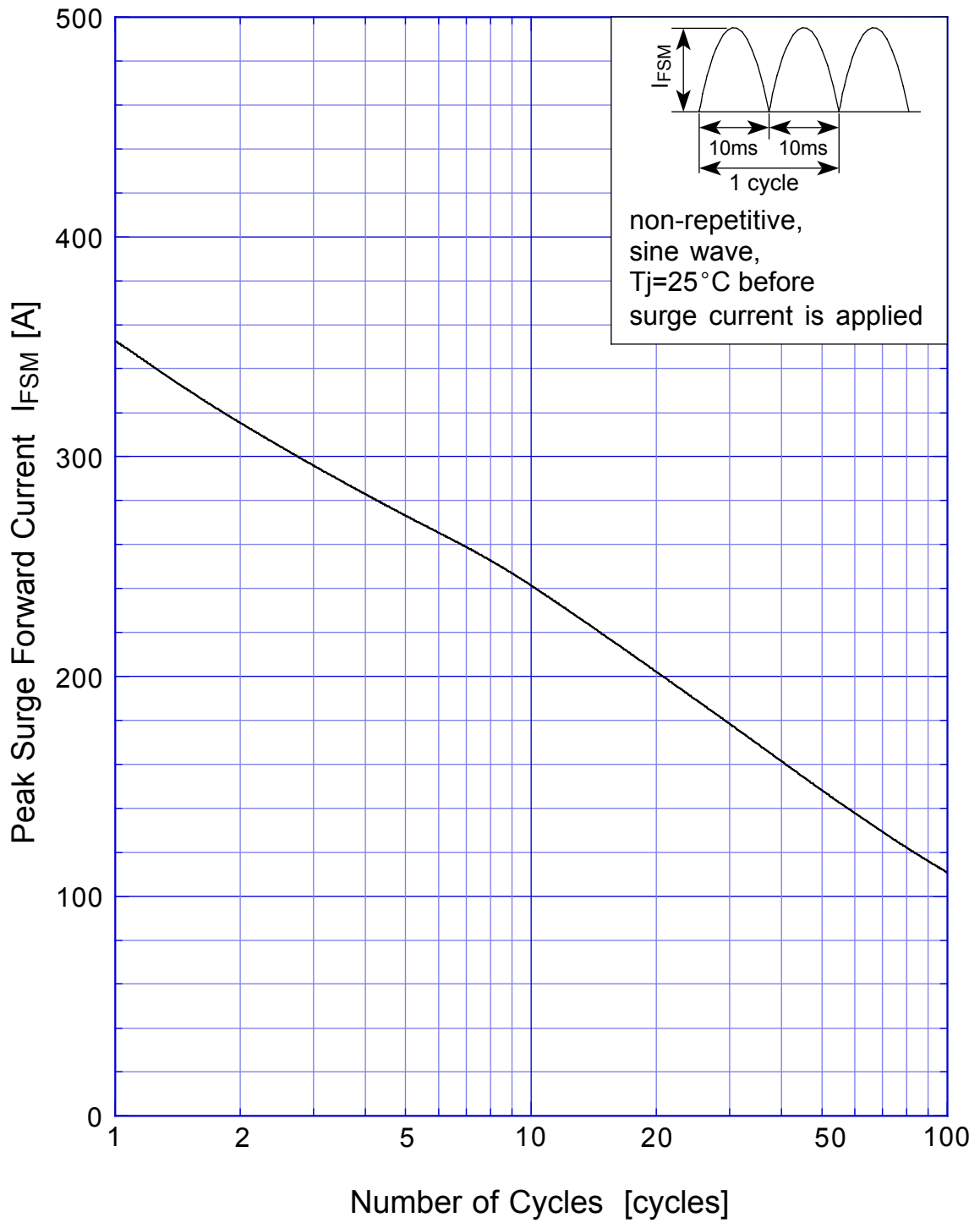



# SBD Repetitive Surge Reverse Power Derating Curve

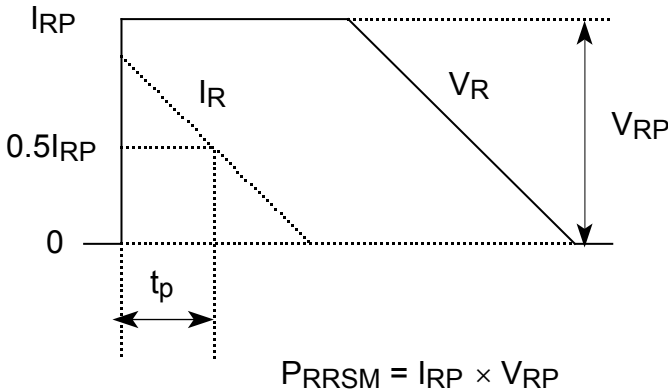
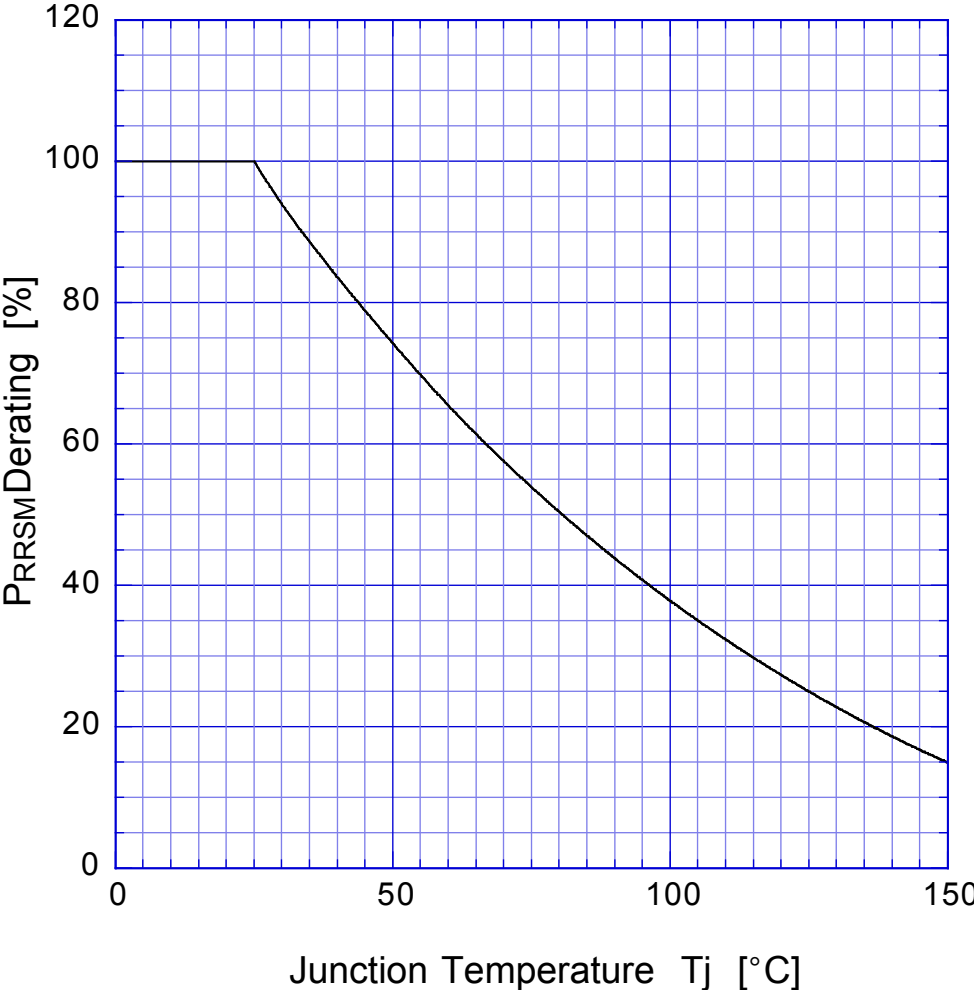

# SBD

## Repetitive Surge Reverse Power Capability

